



**MANAGEMENT DIVISION
DEPARTMENT OF HEALTH SERVICES
MINISTRY OF HEALTH**



**HEALTH BUILDING INFRASTRUCTURE
STANDARD DESIGN DRAWINGS**

TERTIARY LEVEL HOSPITAL



**3D
TERTIARY LEVEL HOSPITAL**

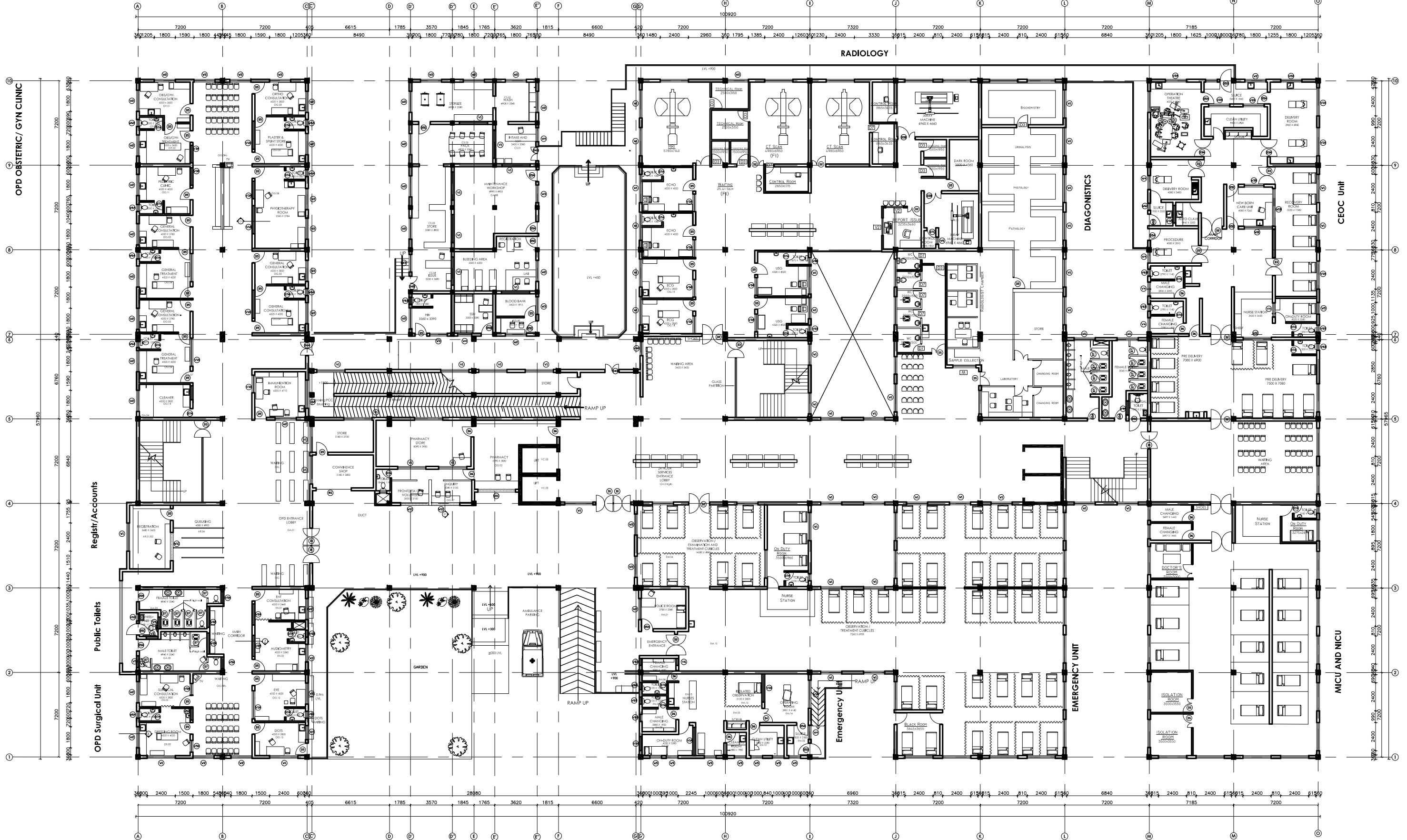

GROUND FLOOR PLAN
GROUND COVERAGE = 4478.12 sq.m.

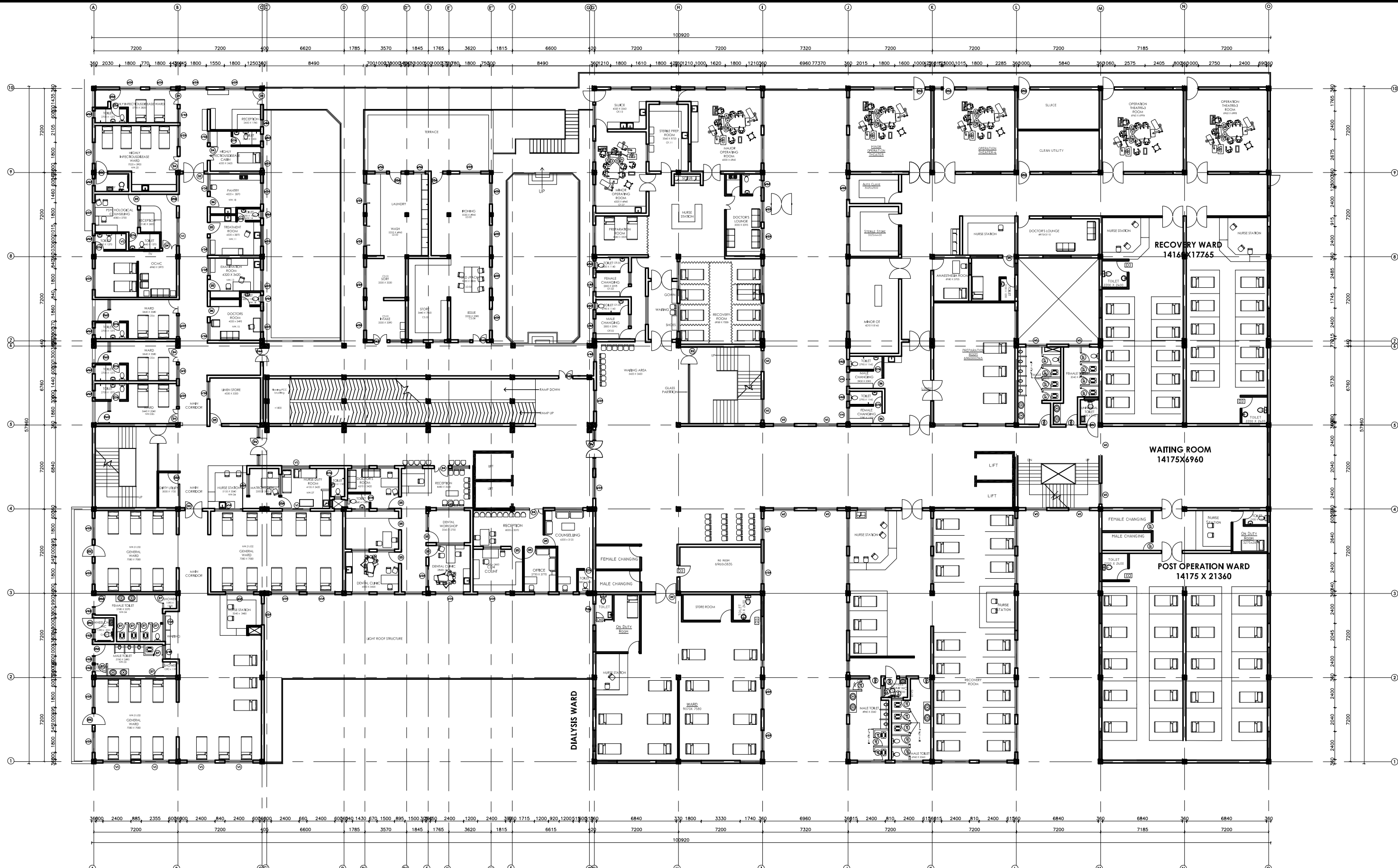

FIRST FLOOR PLAN
 AREA = 4465.12 sq.m.



Management Division
 Department of Health Service
 Ministry of Health



Health Building Infrastructure
 Standard Design Drawings

Job Name:
 TERTIARY HOSPITAL CLASS
 BRICK WALL IN FRAME STRUCTURE
 THREE STORIED

Scale: 1:300

Date: 2073/11/..

Drawing title:
 FIRST Floor Plan
 \with Furniture
 Layout

Sheet no:
 AR/02

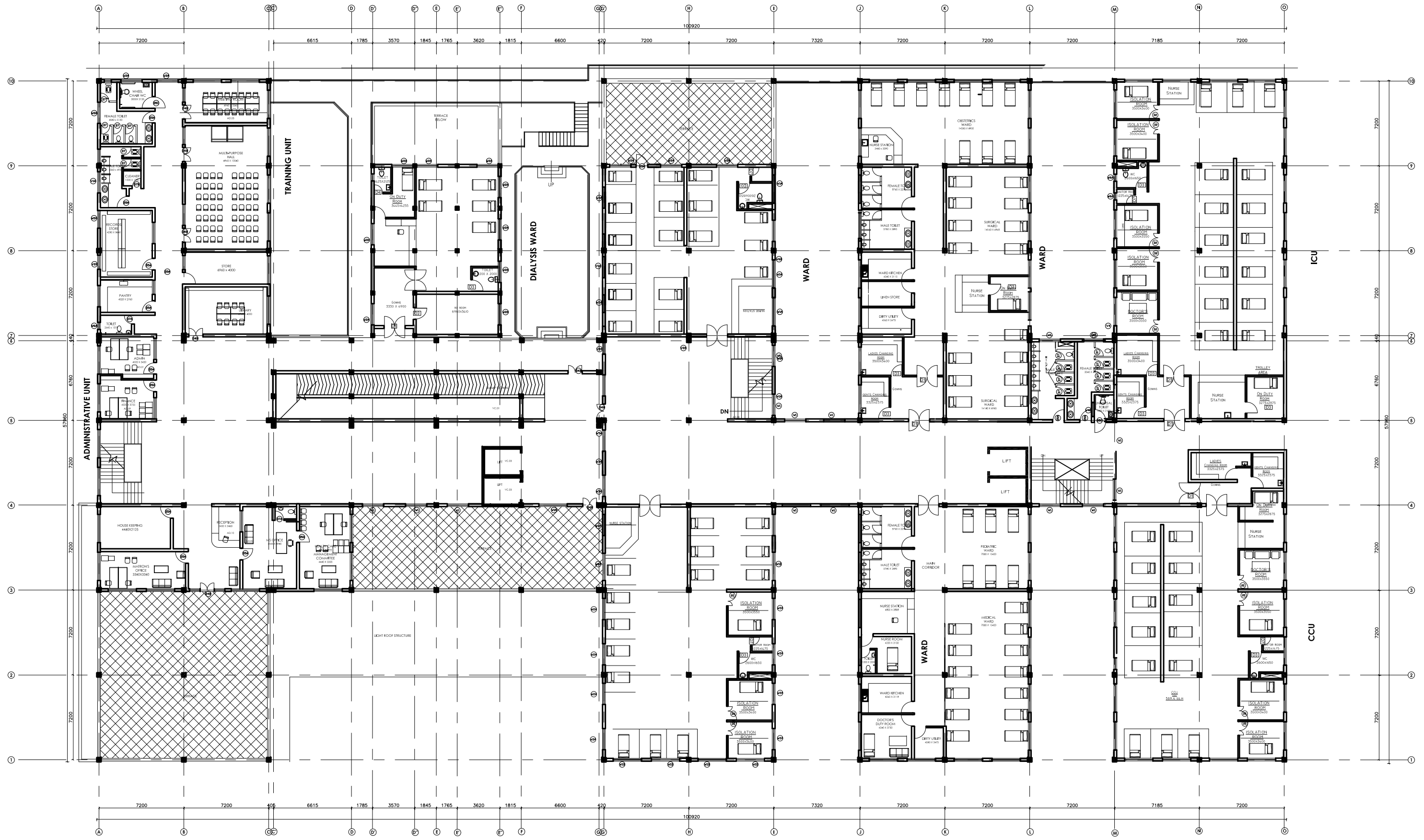

TOP FLOOR PLAN
 AREA = 4045.21 sq.m.



Management Division
Department of Health Service
Ministry of Health



Health Building Infrastructure
Standard Design Drawings

Job Name:
 TERTIARY HOSPITAL CLASS
 BRICK WALL IN FRAME STRUCTURE
 THREE STORIED

Scale: 1:300

Date : 2073/11/..

Drawing title:
 Top Floor Plan
 \with Furniture
 Layout

Sheet no:

AR/03

SECONDARY LEVEL HOSPITAL

**3D
SECONDARY HOSPITAL**



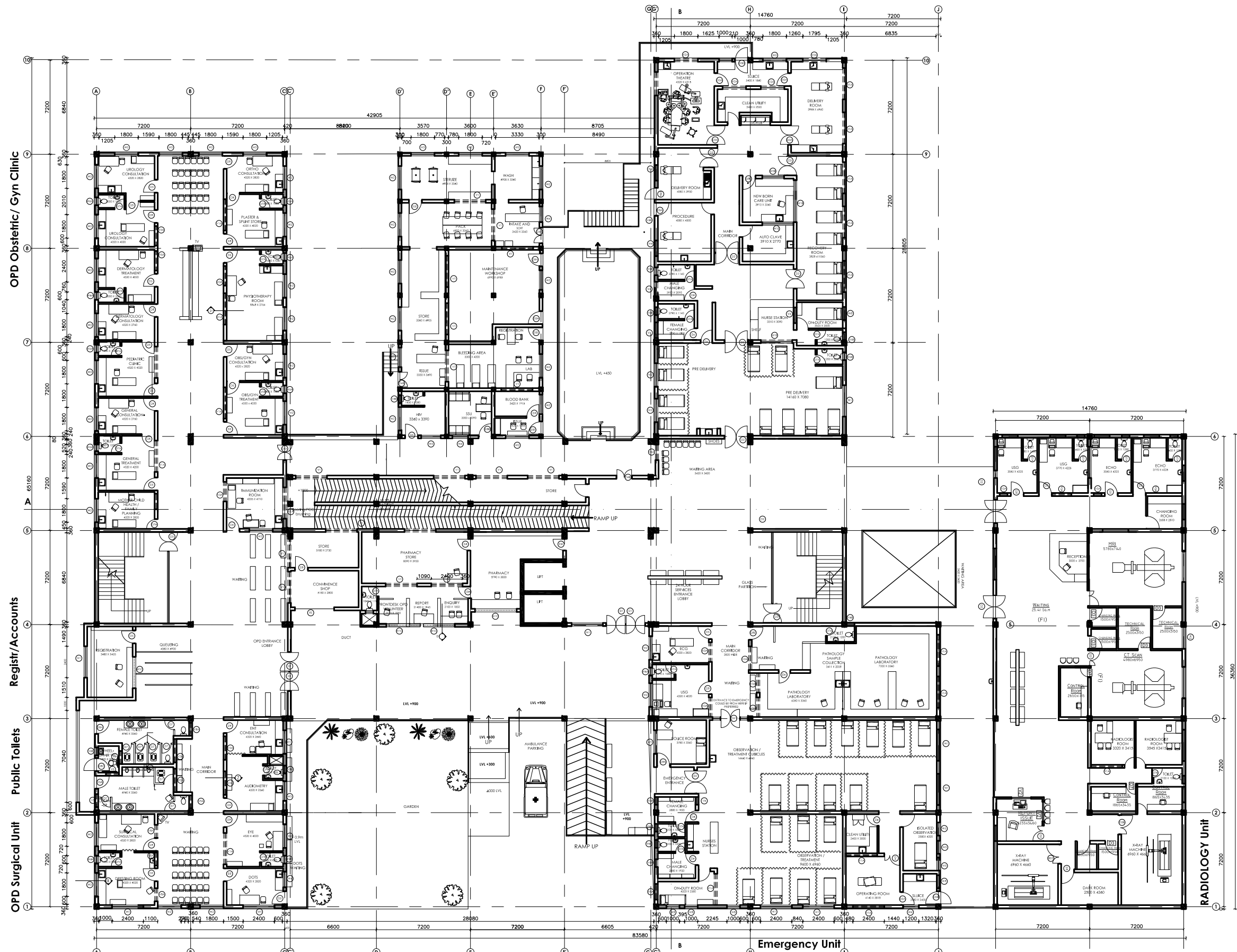

GROUND FLOOR PLAN
GROUND COVERAGE = 3364.50 sq.m.



Management Division
Department of Health Service
Ministry of Health



Health Building Infrastructure
Standard Design Drawings

Job Name:
SECONDARY HOSPITAL
TYPE A: 100-200 BED
BRICK WALL IN FRAME STRUCTURE
THREE STORIED

Scale: 1:300

Date: 2073/11/17

Drawing title:
Ground Floor
Plan \with
Furniture Layout

Sheet no:

AR/01

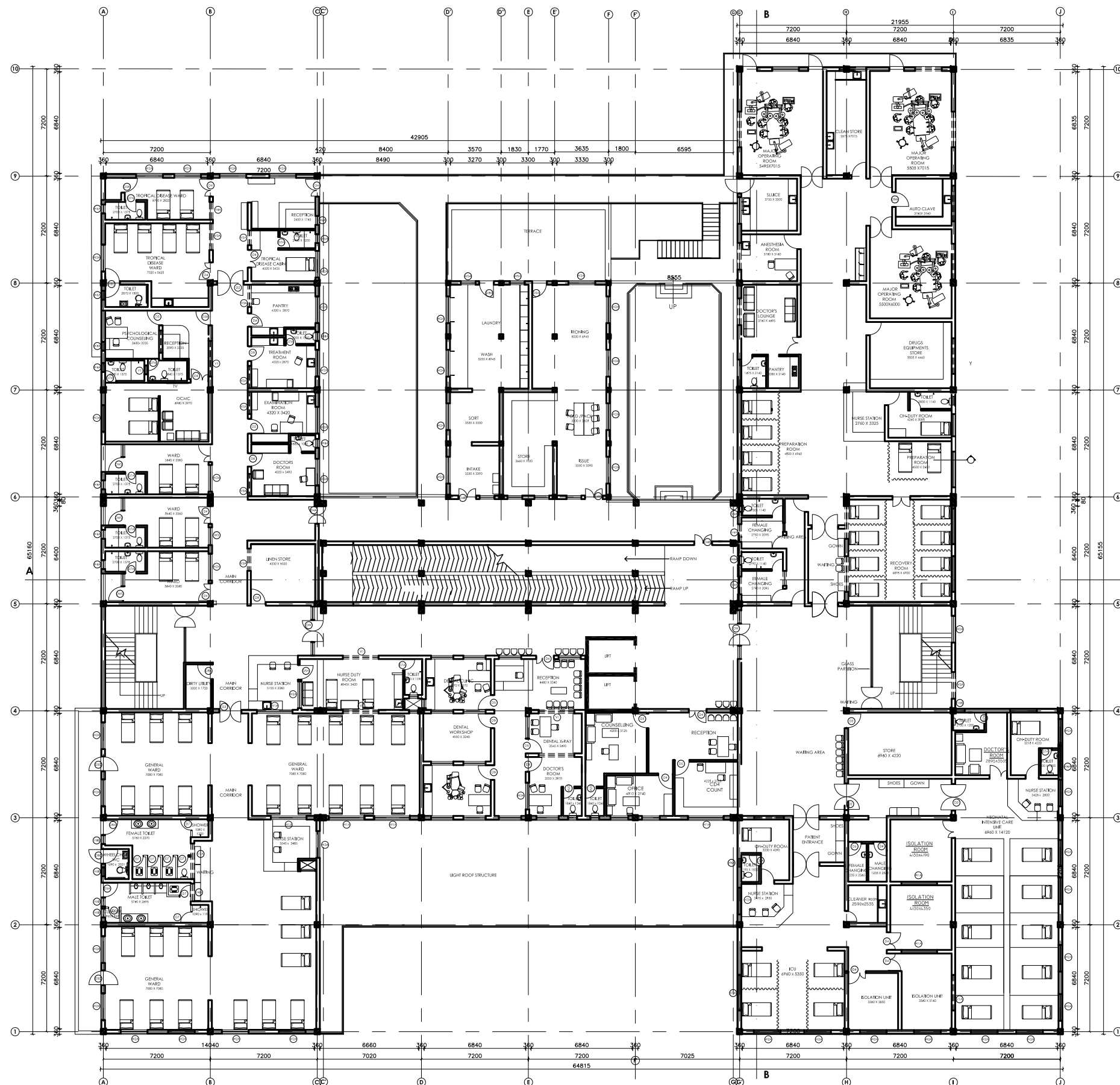

FIRST FLOOR PLAN
 AREA = 2745.077 sq.m.



Management Division
Department of Health Service
Ministry of Health



Health Building Infrastructure
Standard Design Drawings

Job Name:
 SECONDARY HOSPITAL
 TYPE A: 100-200 BED
 BRICK WALL IN FRAME STRUCTURE
 THREE STORIED

Scale: 1:300

Date: 2073/11/17

Drawing title:
 First Floor Plan
 \ with Furniture
 Layout

Sheet no:

AR/02

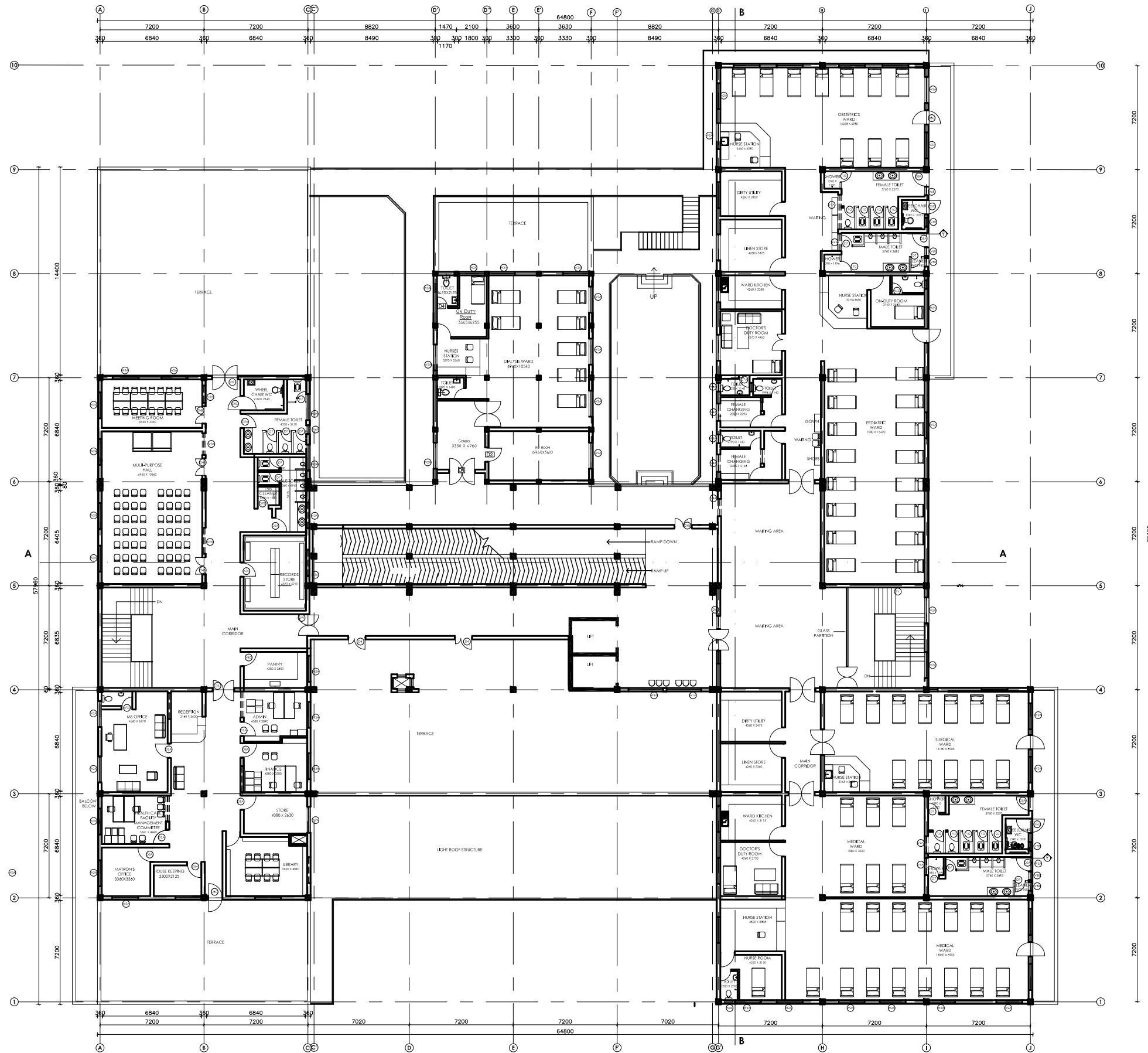

TOP FLOOR PLAN
 AREA = 2426.49 sq.m.



Management Division
Department of Health Service
Ministry of Health



Health Building Infrastructure
Standard Design Drawings

Job Name:
 SECONDARY HOSPITAL
 TYPE A: 100-200 BED
 BRICK WALL IN FRAME STRUCTURE
 THREE STORIED

Scale: 1:300

Date: 2073/11/17

Drawing title:
 Top Floor Plan
 \ with Furniture
 Layout

Sheet no:

AR/03

**PRIMARY HOSPITAL
CLASS A TYPE 1**

**3D
PRIMARY HOSPITAL CLASS A TYPE 1**



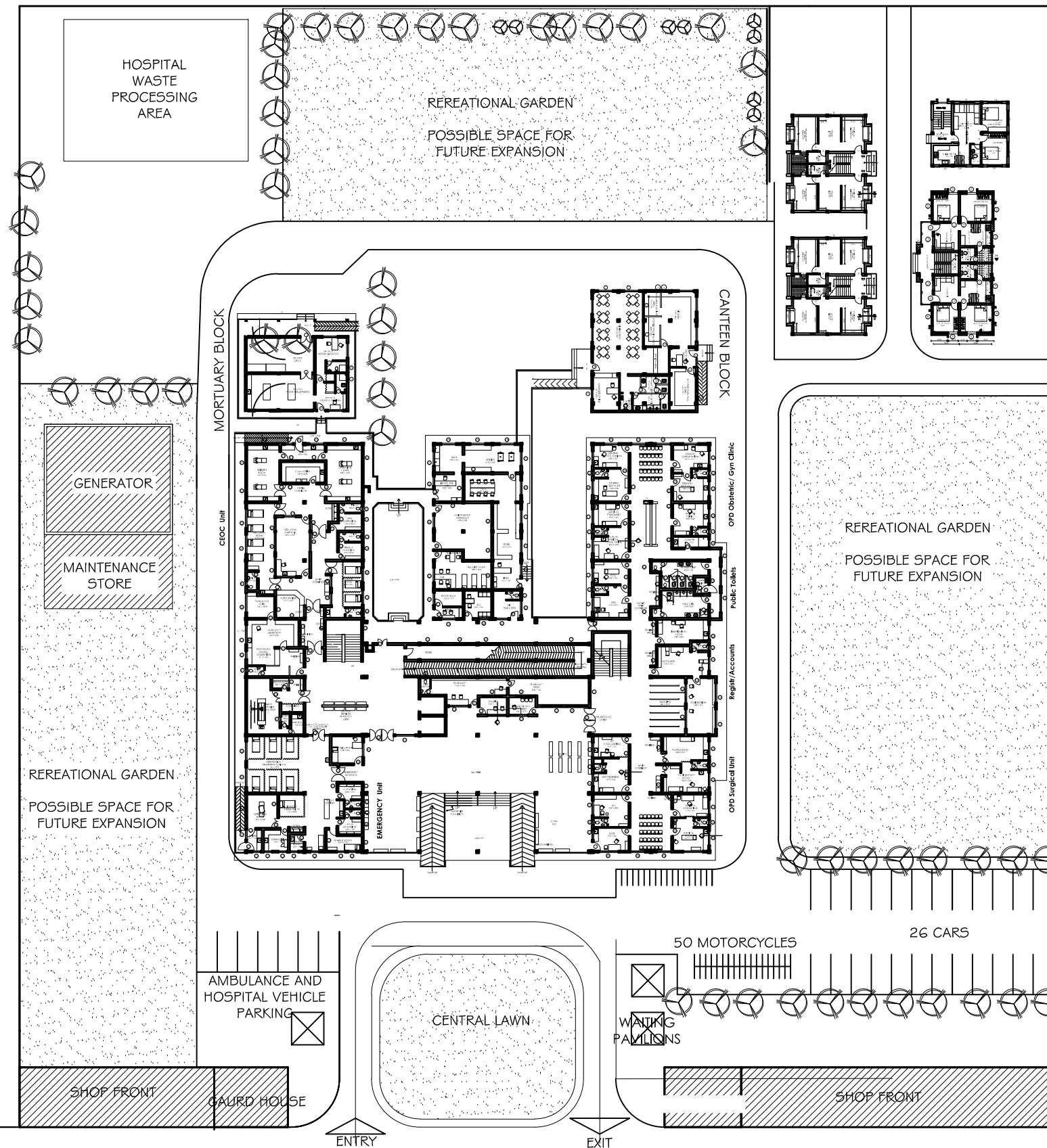

Management Division
Department of Health Service
Ministry of Health & Population



Health Building Infrastructure
Standard Design Drawings

Job Name:
PRIMARY HOSPITAL CLASS A TYPE 1
Frame structure
Three storied

Scale: 1:250

Date : 2073/11/7

Drawing title:
Master Plan

Sheet no:

AR/00

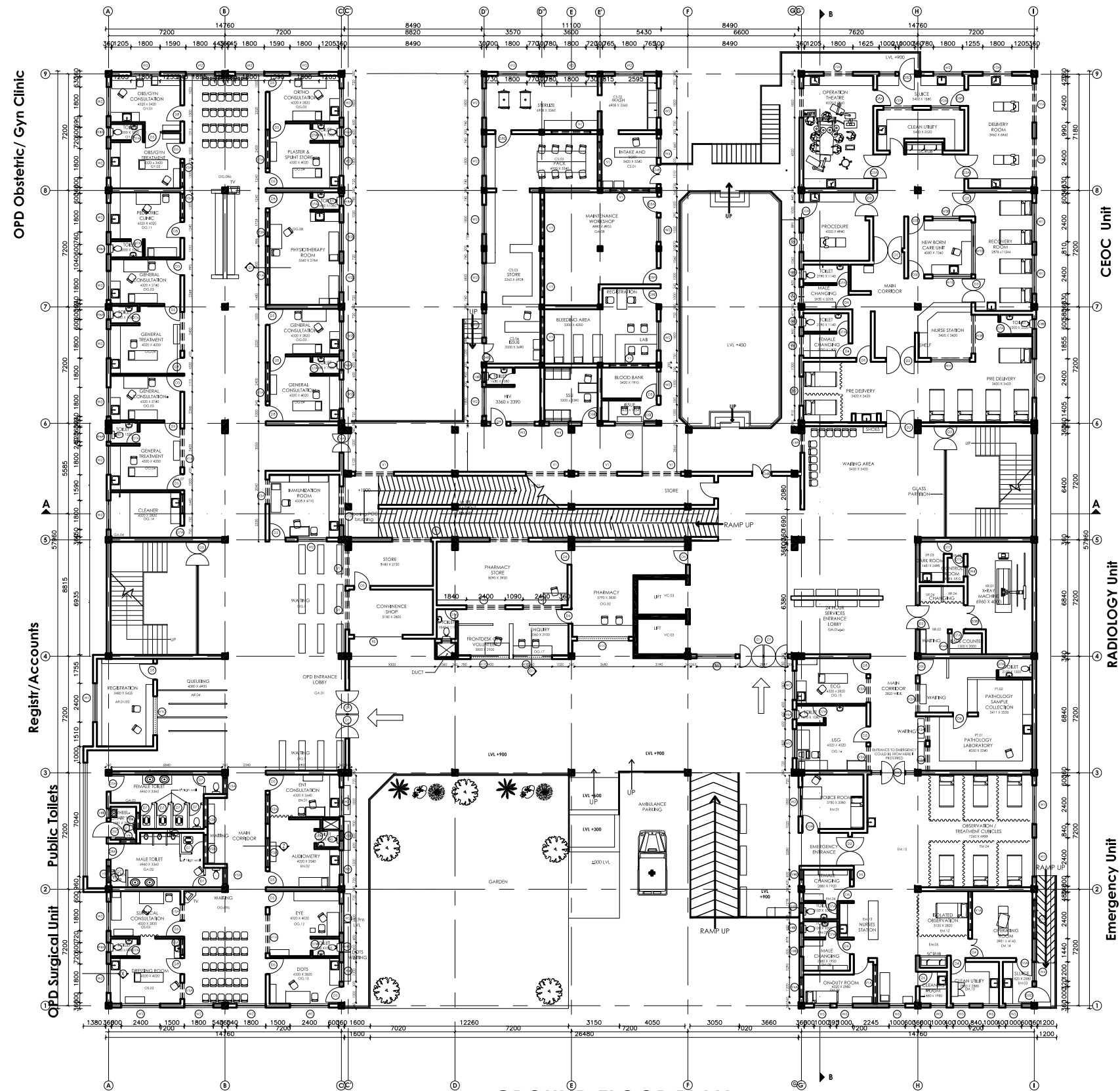

GROUND FLOOR PLAN
GROUND COVERAGE = 2754.51 sq.m.



Management Division
Department of Health Service
Ministry of Health



Health Building Infrastructure
Standard Design Drawings

Job Name:
PRIMARY HOSPITAL CLASS A
TYPE 1
BRICK WALL IN FRAME STRUCTURE
THREE STORIED

Scale: 1:300

Date: 2073/11/..

Drawing title:
Ground Floor
Plan \with
Furniture Layout

Sheet no:

AR/01

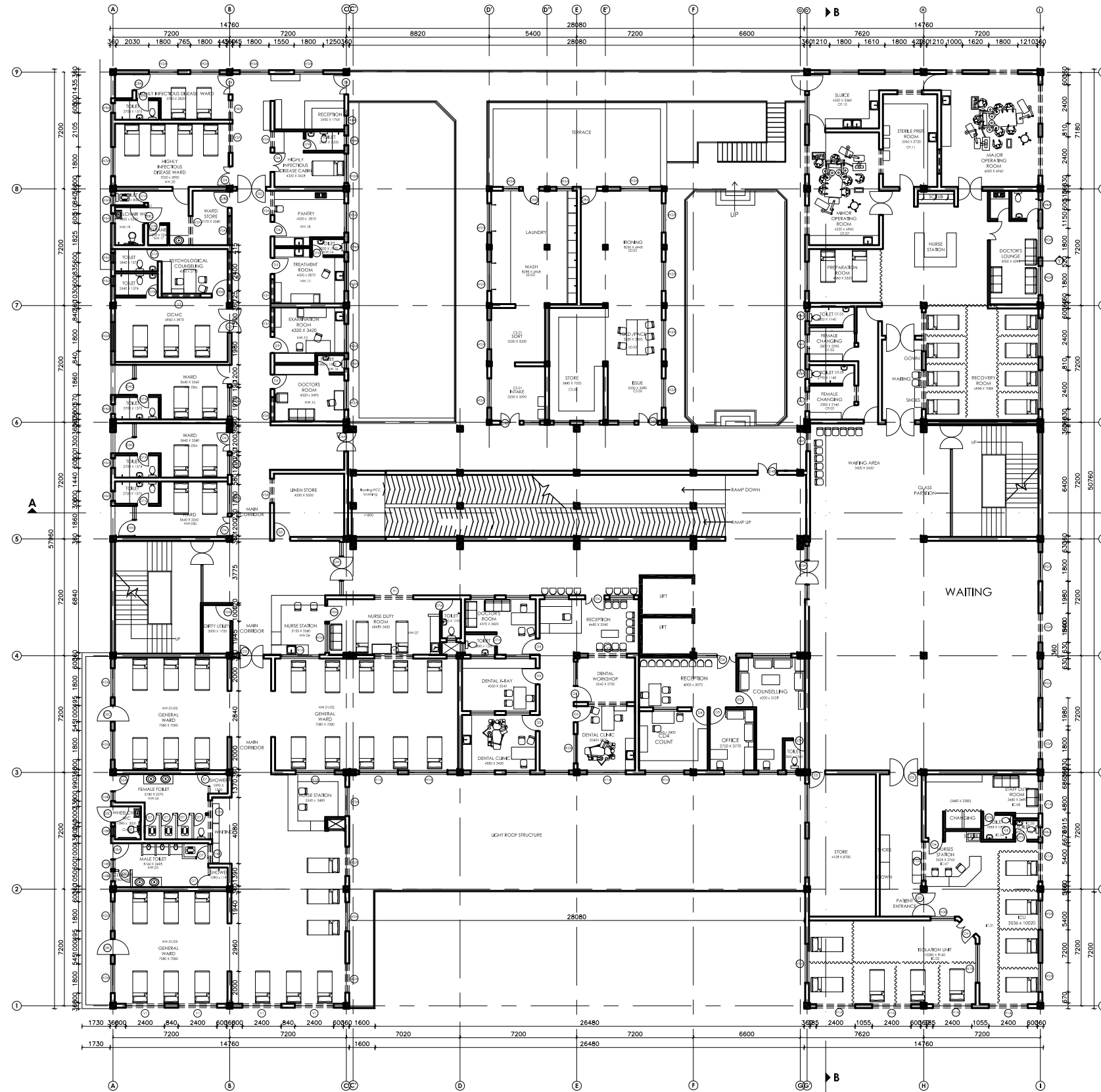

FIRST FLOOR PLAN
 AREA = 2611.55 sq.m.

Management Division
 Department of Health Service
 Ministry of Health



**Health Building Infrastructure
 Standard Design Drawings**

Job Name:
 PRIMARY HOSPITAL CLASS A
 TYPE 1
 BRICK WALL IN FRAME STRUCTURE
 THREE STORIED

Scale: 1:300

Date: 2073/11/..

Drawing title:
 First Floor Plan
 \ with Furniture
 Layout

Sheet no:

AR/02

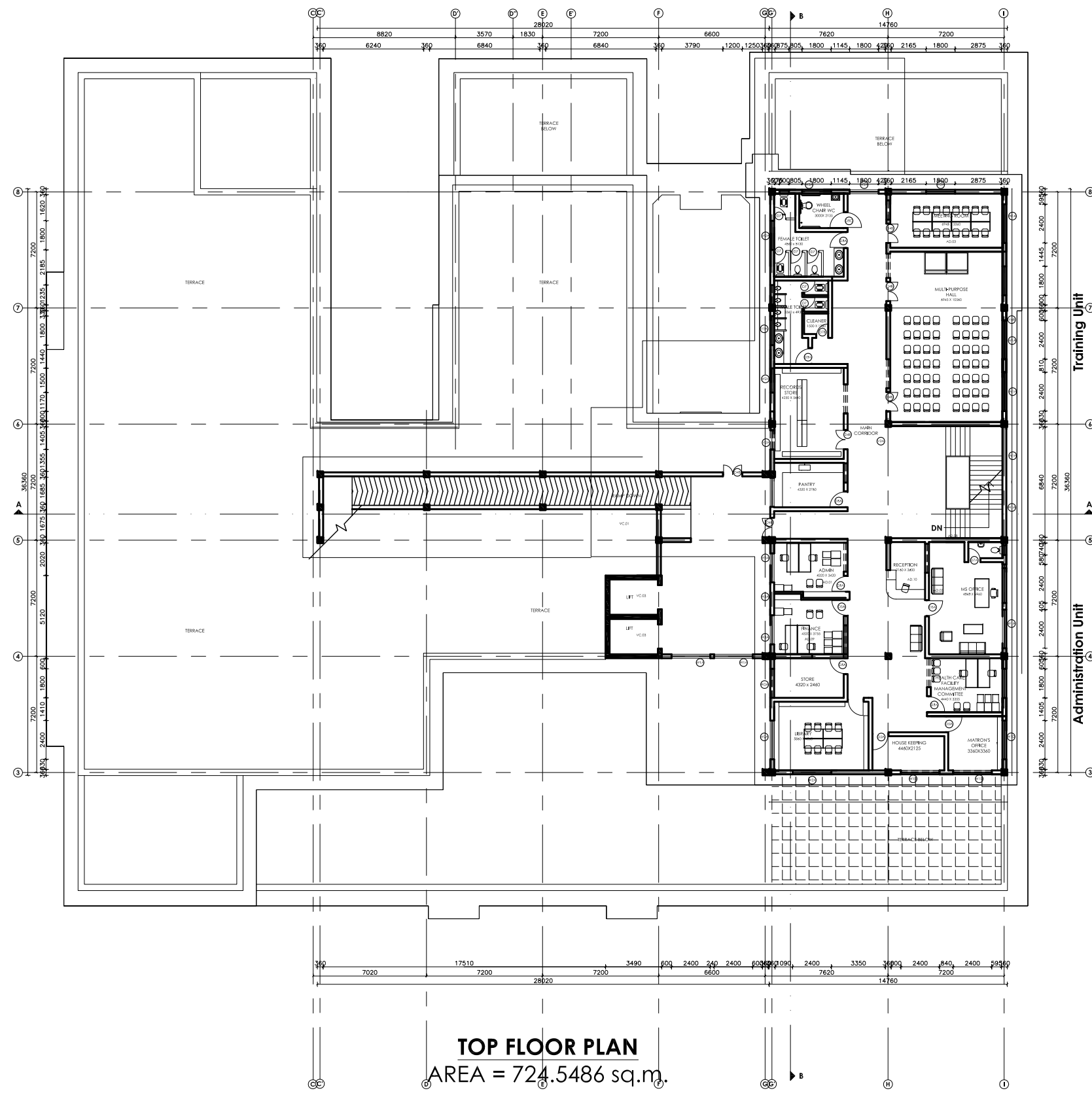

TOP FLOOR PLAN
 AREA = 724.5486 sq.m.



Management Division
 Department of Health Service
 Ministry of Health



Health Building Infrastructure
 Standard Design Drawings

Job Name:
 PRIMARY HOSPITAL CLASS A
 TYPE 1
 BRICK WALL IN FRAME STRUCTURE
 THREE STORIED

Scale: 1:300

Date : 2073/11/..

Drawing title:
 Top Floor Plan
 \ with Furniture
 Layout

Sheet no:
AR/03

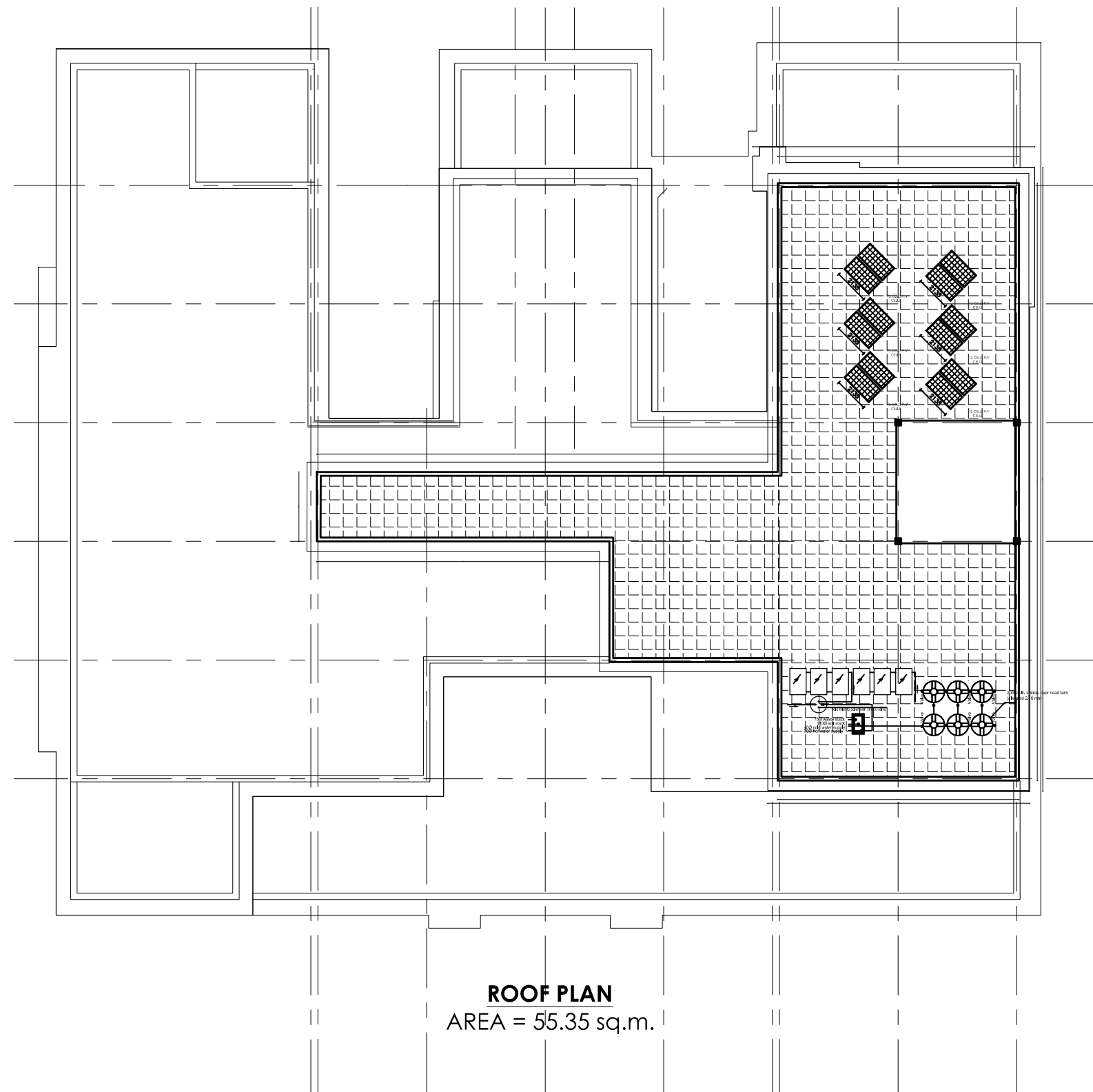

**Management Division
Department of Health Service
Ministry of Health**



**Health Building Infrastructure
Standard Design Drawings**

Job Name:
PRIMARY HOSPITAL CLASS A
TYPE 1
FRAME STRUCTURE
THREE STORIED

Scale: 1:300

Date : 2073/11/..

Drawing title:

ROOF Plan \ with
Solar Panel

Sheet no:

AR/04



FRONT ELEVATION



BACK ELEVATION



SIDE ELEVATION



**Management Division
Department of Health Service
Ministry of Health**



**Health Building Infrastructure
Standard Design Drawings**

Job Name:
PRIMARY HOSPITAL CLASS A
TYPE 1
Frame structure
Three storied

Scale: 1:250

Date : 2070/6/7

Drawing title:
Elevations

Sheet no:

AR/05



SIDE ELEVATION

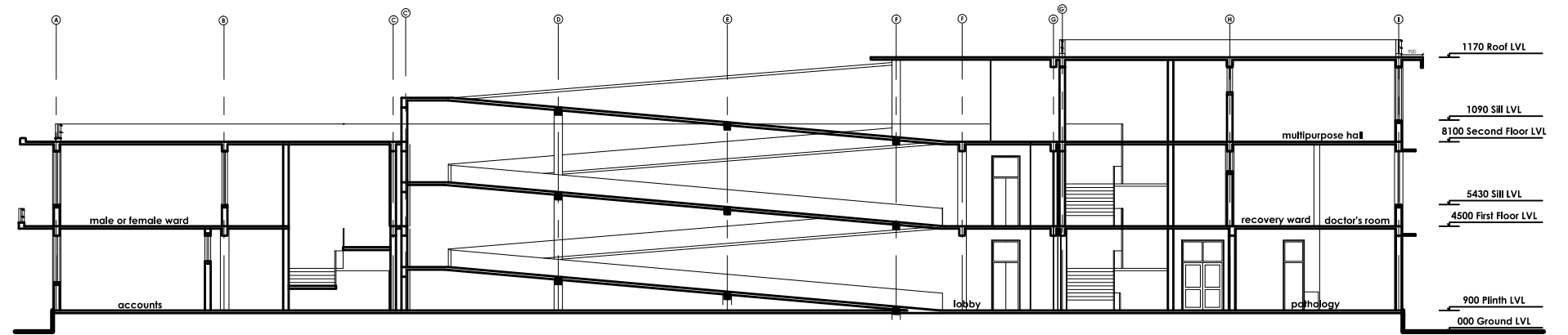

SECTION AT A-A

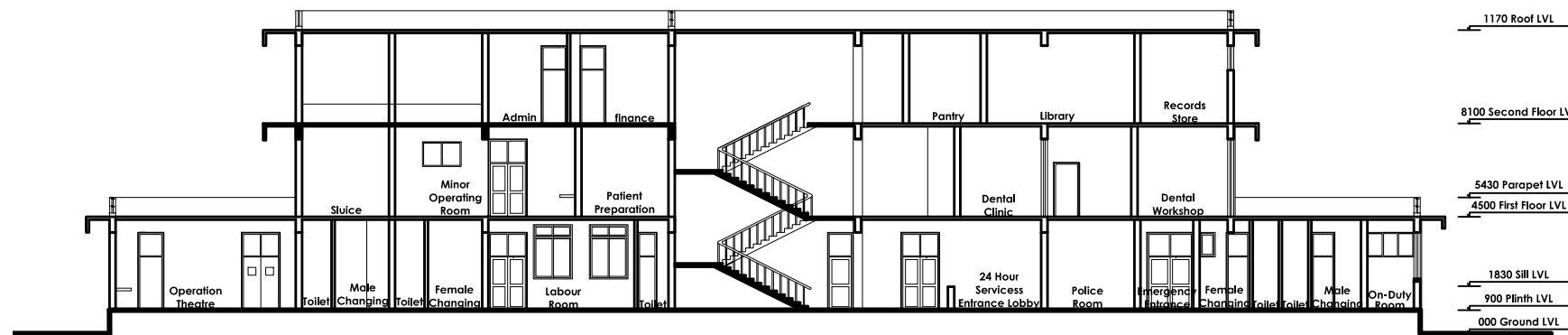

SECTION AT B-B



**Management Division
Department of Health Service
Ministry of Health**



**Health Building Infrastructure
Standard Design Drawings**

Job Name:
PRIMARY HOSPITAL CLASS A
TYPE 1
Frame structure
Three storied

Scale: 1:250

Date: 2070/6/7

Drawing title:
Elevation &
Sections

Sheet no:

AR/06

OPENING TYPE	W1	W1A	W1B	W1C	W1D	W1E
SHAPE AND SIZE						
QUANTITY	12	22	3	4	3	2
SPECIFICATION	SLIDING	SLIDING	FIXED	SLIDING	FIXED	
LOCATION	GROUND FLOOR	FIRST FLOOR	GROUND FLOOR	GROUND FLOOR	SECOND FLOOR	
OPENING TYPE	W2	W2A	W3	W3A	W3B	W4
SHAPE AND SIZE						
QUANTITY	38	44	5	5	6	4
SPECIFICATION	SLIDING	SLIDING	SLIDING	SLIDING	FIXED	SLIDING
LOCATION	GROUND FLOOR	FIRST FLOOR	GROUND FLOOR	FIRST FLOOR		GROUND FLOOR
OPENING TYPE	W4A	W5	W5A	W6	W6A	
SHAPE AND SIZE						
QUANTITY	1	11	6	1	23	
SPECIFICATION	SLIDING	SLIDING	SLIDING	MOVABLE	MOVABLE	
LOCATION	GROUND FLOOR	FIRST FLOOR	GROUND FLOOR	FIRST FLOOR	GROUND FLOOR	



Management Division
Department of Health Service
Ministry of Health



Health Building Infrastructure
Standard Design Drawings

Job Name:
PRIMARY HOSPITAL CLASS A
TYPE 1
Frame structure
Three storied
Scale: 1:100
Date: 2070/6/7

Drawing title:
Opening
Schedule

Sheet no:

AR/7

OPENING TYPE	D1	D2	D3	D3A	D3B	D4
FLOOR LEVEL LINTEL LEVEL SHAPE AND SIZE FLOOR FINISH LEVEL STRUCTURE LEVEL						
QUANTITY	2	8	6	4	1	15
SPECIFICATION	upper half- transparent glass, lower half panel; both way swing	upper half- transparent glass, lower half panel; both way swing	upper half- transparent glass, lower half panel; both way swing	flush door with viewing pane ; both way swing	Lead lined Door	flush door with viewing pane
LOCATION	Main door	Corridor , Emergency Main Door	Labour Room, Recovery room, Main Entrance of ICU	OT, Delivery	X-Ray	Wards, Plaster room, Surgery Room, Physiotherapy Room
OPENING TYPE	D4A	D4B	D5	D5A	D5B	D5C
FLOOR LEVEL LINTEL LEVEL SHAPE AND SIZE FLOOR FINISH LEVEL STRUCTURE LEVEL						
QUANTITY	2	11	28	32	4	7
SPECIFICATION	Double Swing with upper half Glass, lower half panned door	Panned Door	Panned with viewing pane	Panned door	Panned door	Double Swing Panned door
LOCATION	back exit of opd	Meeting Room, Multipurpose Hall, Laundry, CSSD	OPD	Toilet Main Door, Laundry, Reg	Store	Disabled Toilet Door, Door towards verandah in ward
OPENING TYPE	D5D	D5E	D5F	D6	D7	D7A
FLOOR LEVEL LINTEL LEVEL SHAPE AND SIZE FLOOR FINISH LEVEL STRUCTURE LEVEL						
QUANTITY	3	6	1	18	22	37
SPECIFICATION	Double Swing with upper half Glass, lower half panned door	Upper half Glass, lower half panned door	Lead lined Door	Panned door	Panned door	Panned door
LOCATION	Sluice	Autoclave, blood bank	Dental X-Ray	Duty room, Changing room, Patients kitchen	Inner Toilet Door	Attached toilet door



Management Division
Department of Health Service
Ministry of Health



Health Building Infrastructure
Standard Design Drawings

Job Name:
PRIMARY HOSPITAL CLASS A
TYPE 1
Frame structure
Three storied
Scale: 1:100
Date : 2070/6/7

Drawing title:
Opening
Schedule

Sheet no:

AR/8

OPENING TYPE	D7B	D7C	DW	DW1	DW2	
SHAPE AND SIZE						
QUANTITY	2	2	2	1	2	
SPECIFICATION	Panned door	Lead lined door				
LOCATION	Janitors closet	Dark Room of Xray				
OPENING TYPE	V1	V1A	V2	V2A	V3A	V4
SHAPE AND SIZE						
QUANTITY	20	22	2	32	17	2
SPECIFICATION	SLIDING	FIXED	SLIDING	FIXED	SLIDING	SLIDING
LOCATION	FIRST FLOOR		GROUND FLOOR			
OPENING TYPE	V4A	V5	V5A	V6	V6B	
SHAPE AND SIZE						
QUANTITY	11	7	6	5	17	
SPECIFICATION	SLIDING	FIXED	FIXED LEAD LINED WINDOW	FIXED		
LOCATION	GROUND FLOOR			GROUND FLOOR		



Management Division
Department of Health Service
Ministry of Health



Health Building Infrastructure
Standard Design Drawings

Job Name:
PRIMARY HOSPITAL CLASS A
TYPE 1
Frame structure
Three storied
Scale: 1:100
Date : 2070/6/7

Drawing title:
Opening
Schedule

Sheet no:

AR/9

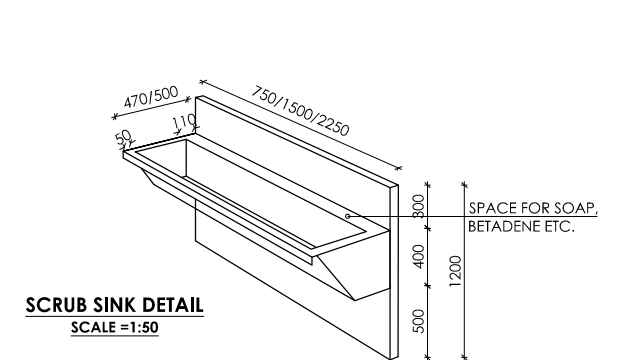
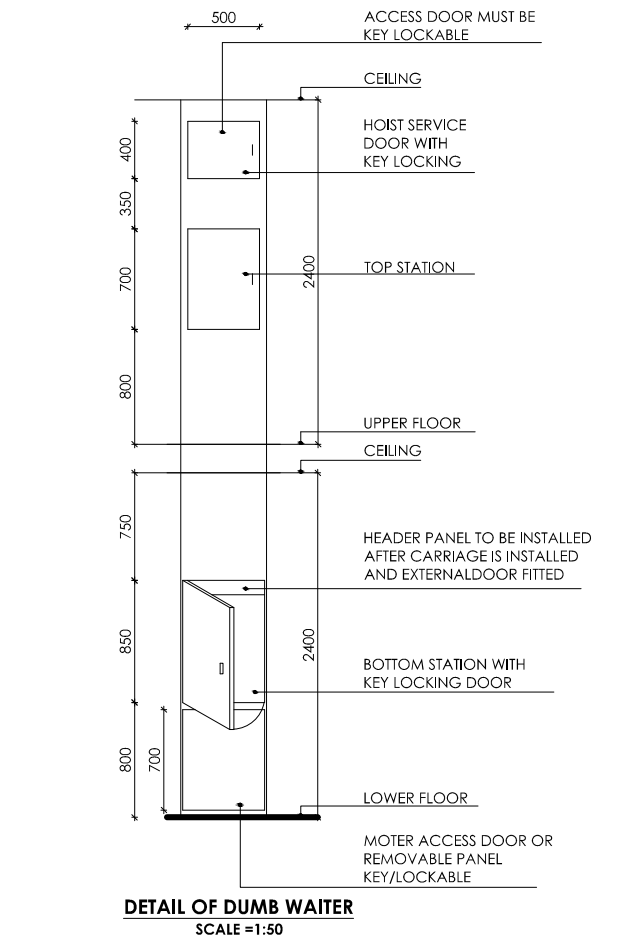
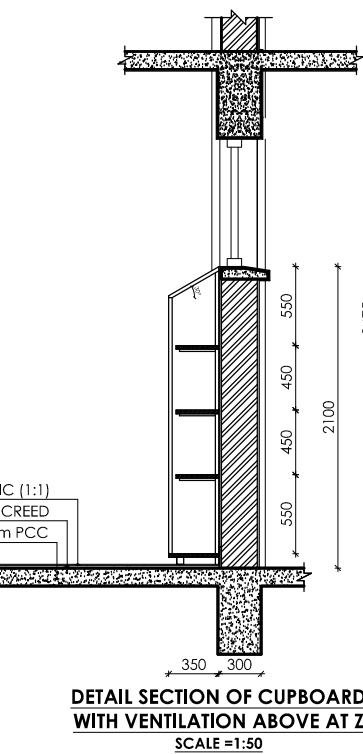
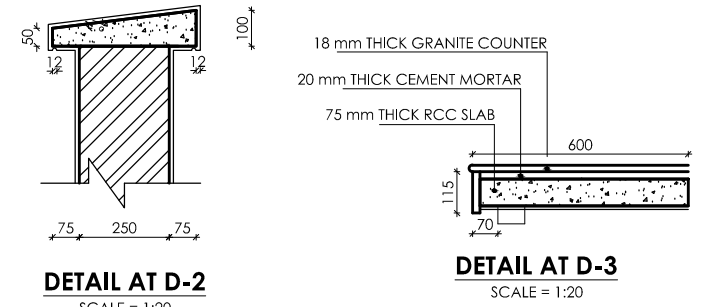
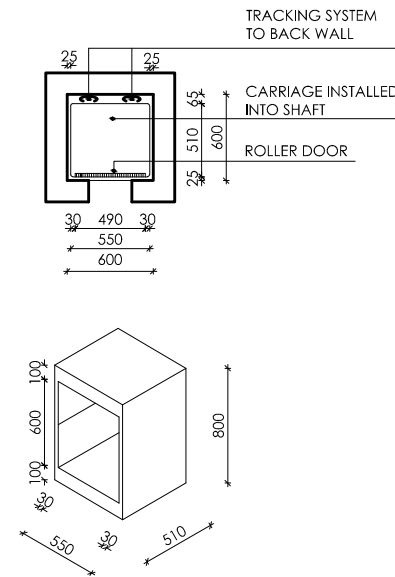
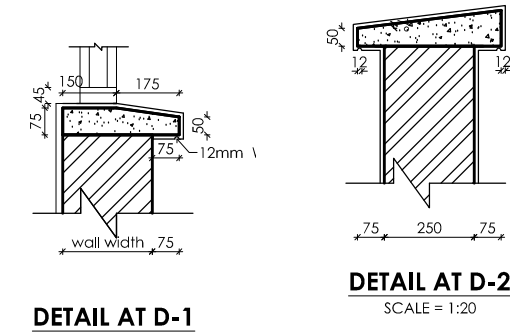
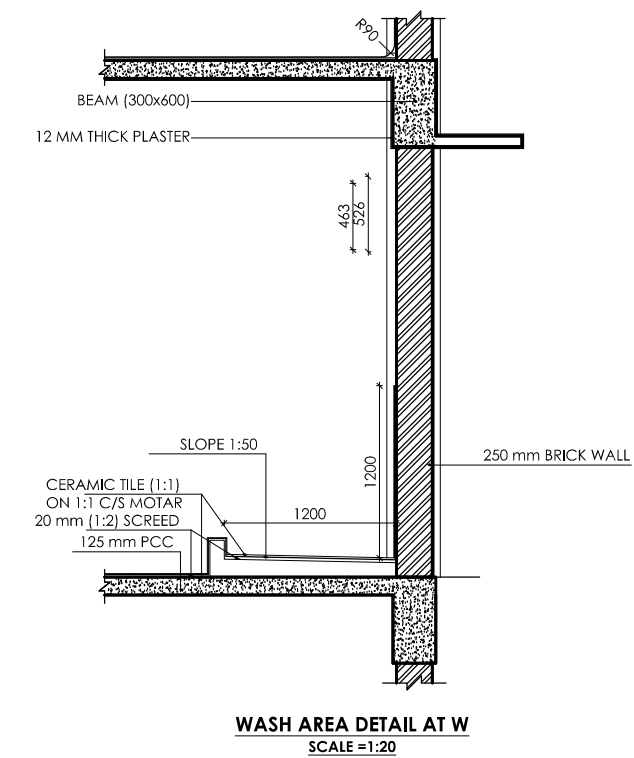
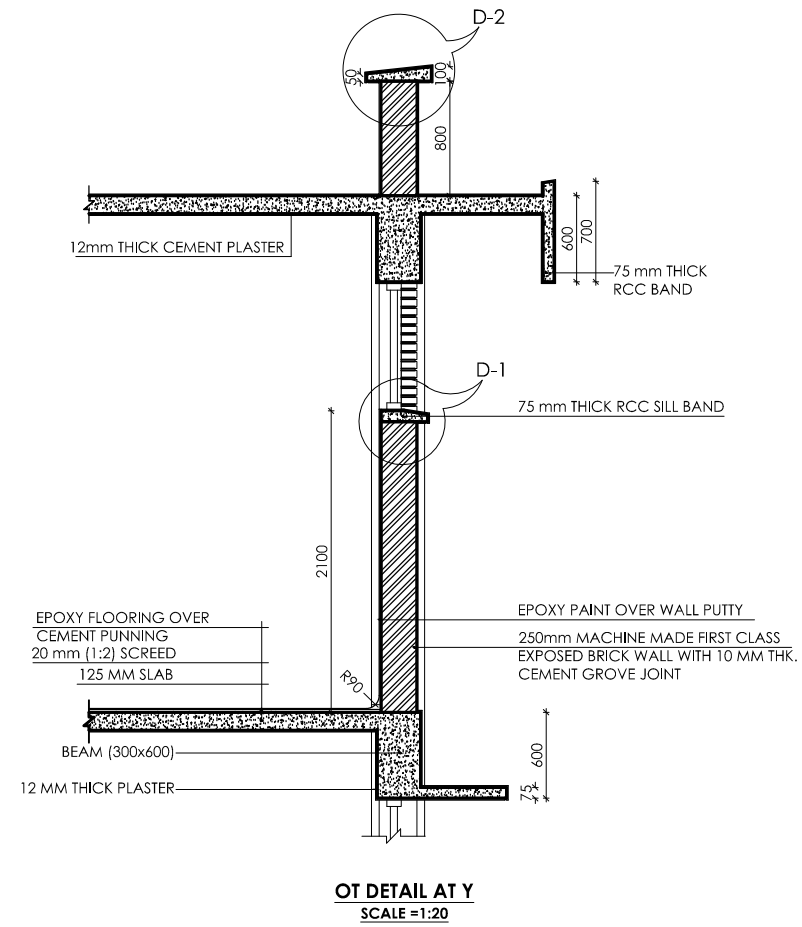
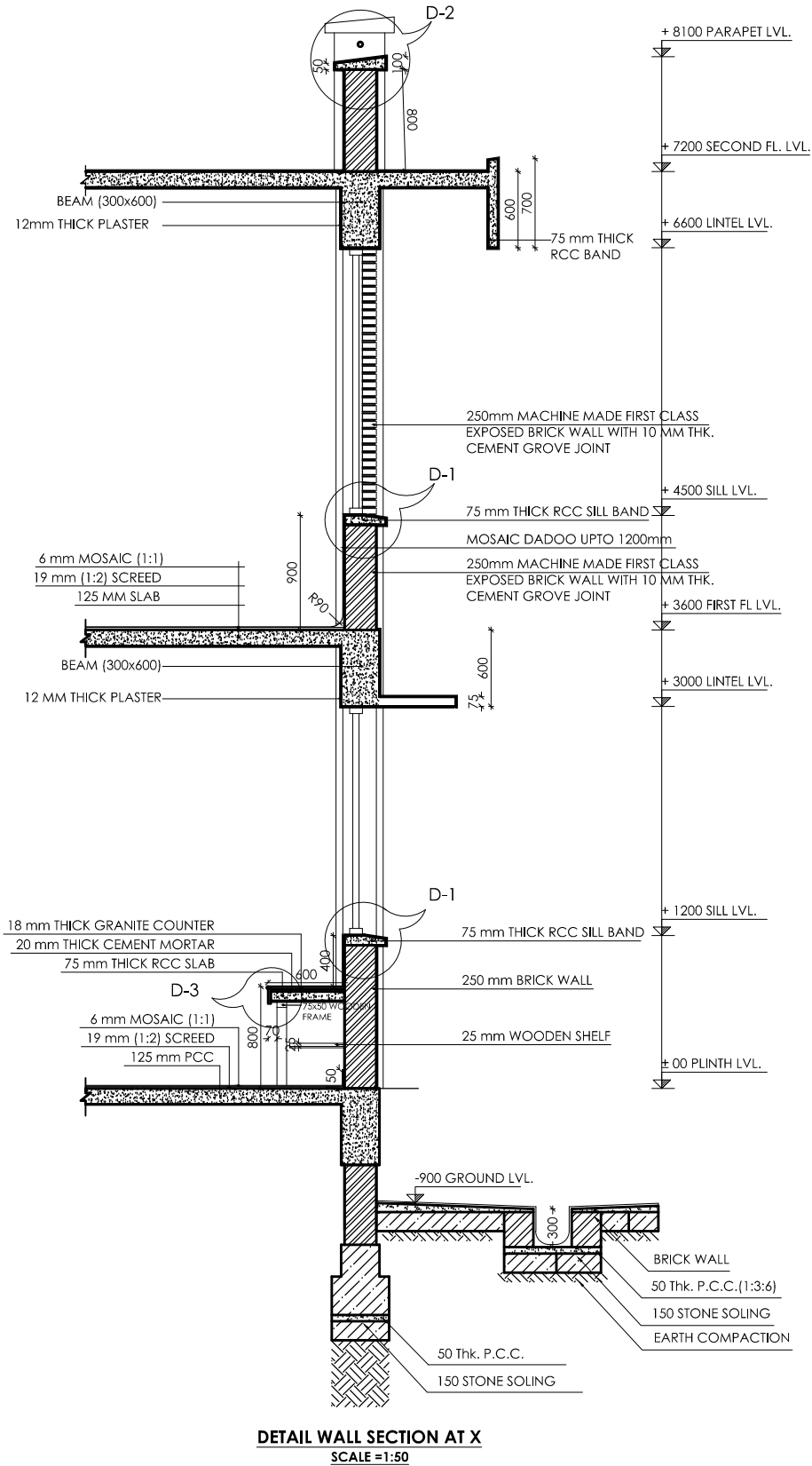

Management Division
Department of Health Service
Ministry of Health



Health Building Infrastructure
Standard Design Drawings

Job Name:
PRIMARY HOSPITAL CLASS A
TYPE 1
Frame structure
Three storied

Scale: As shown

Date: 2070/6/7

Drawing title:
Details

Sheet no:

AR/10

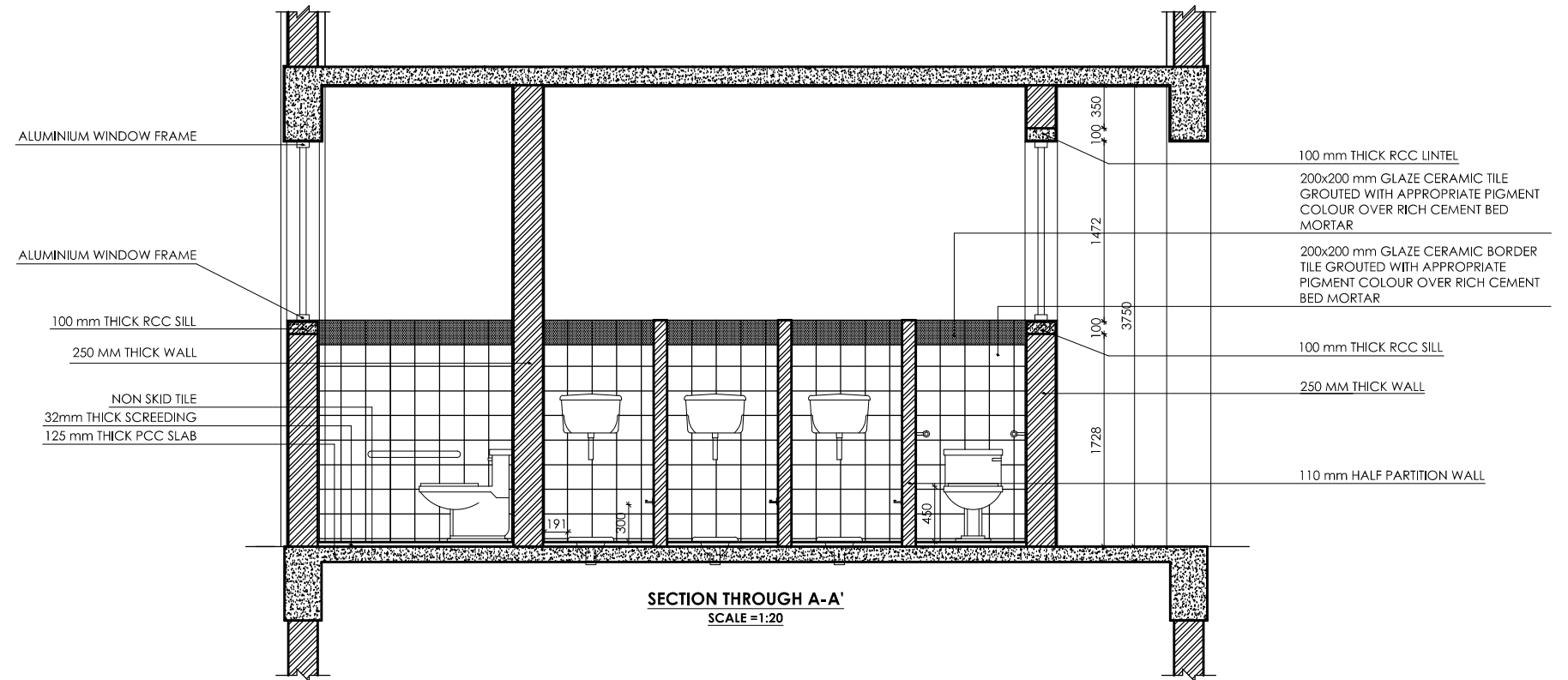
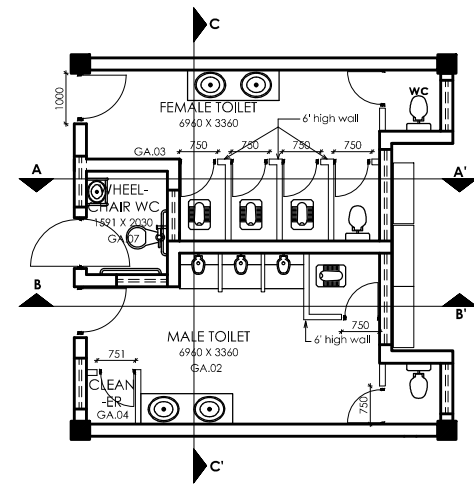

SECTION THROUGH A-A'
SCALE = 1:20

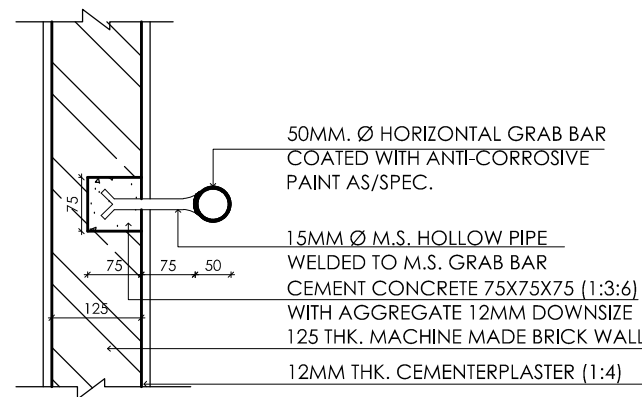

GRAB BAR DETAIL
Scale-1:10

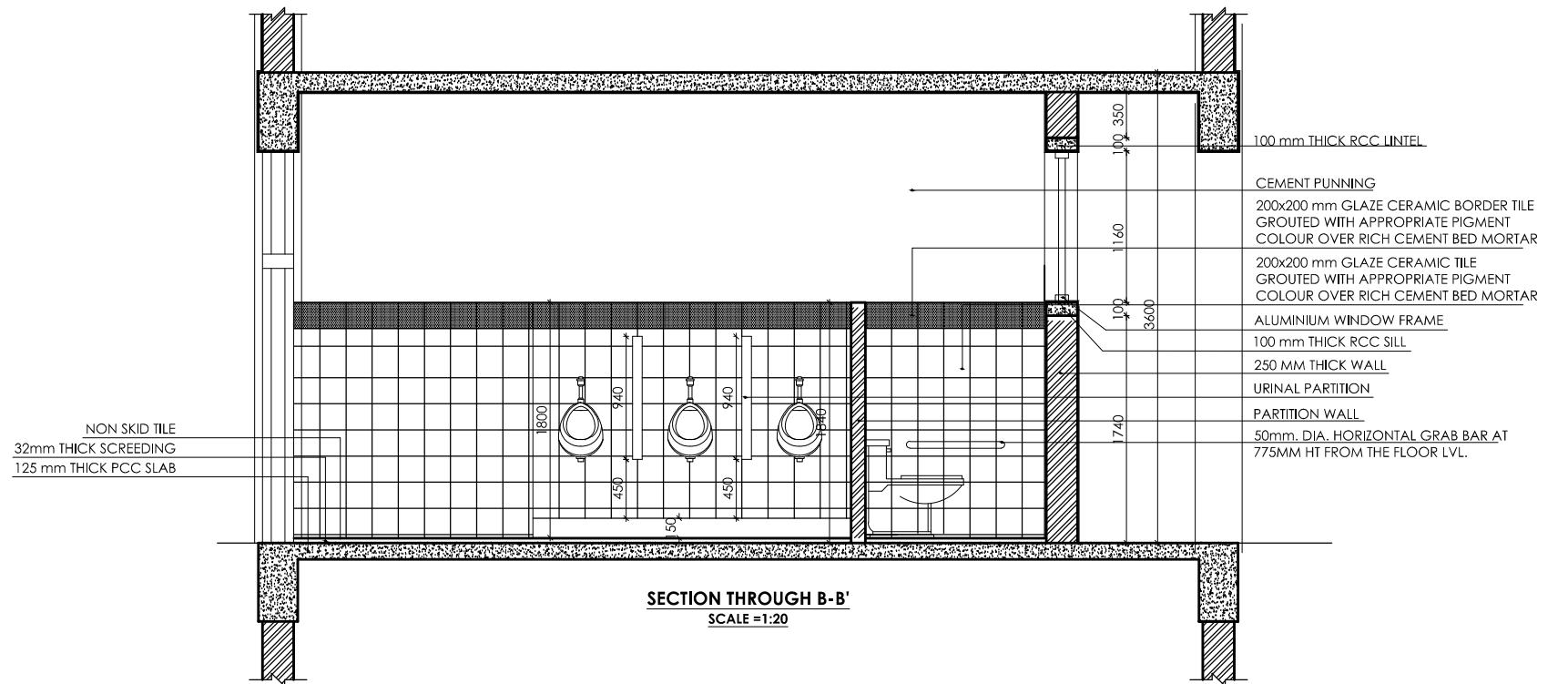

SECTION THROUGH B-B'
SCALE = 1:20



Management Division
Department of Health Service
Ministry of Health



Health Building Infrastructure
Standard Design Drawings

Job Name:
PRIMARY HOSPITAL CLASS A
TYPE 1
Frame structure
Three storied

Scale: As shown

Date : 2070/6/7

Drawing title:
Detail

Sheet no:

AR/11

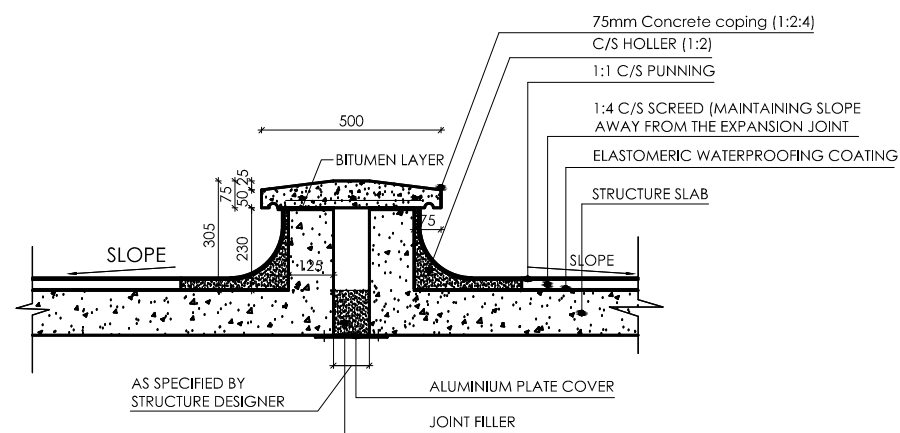
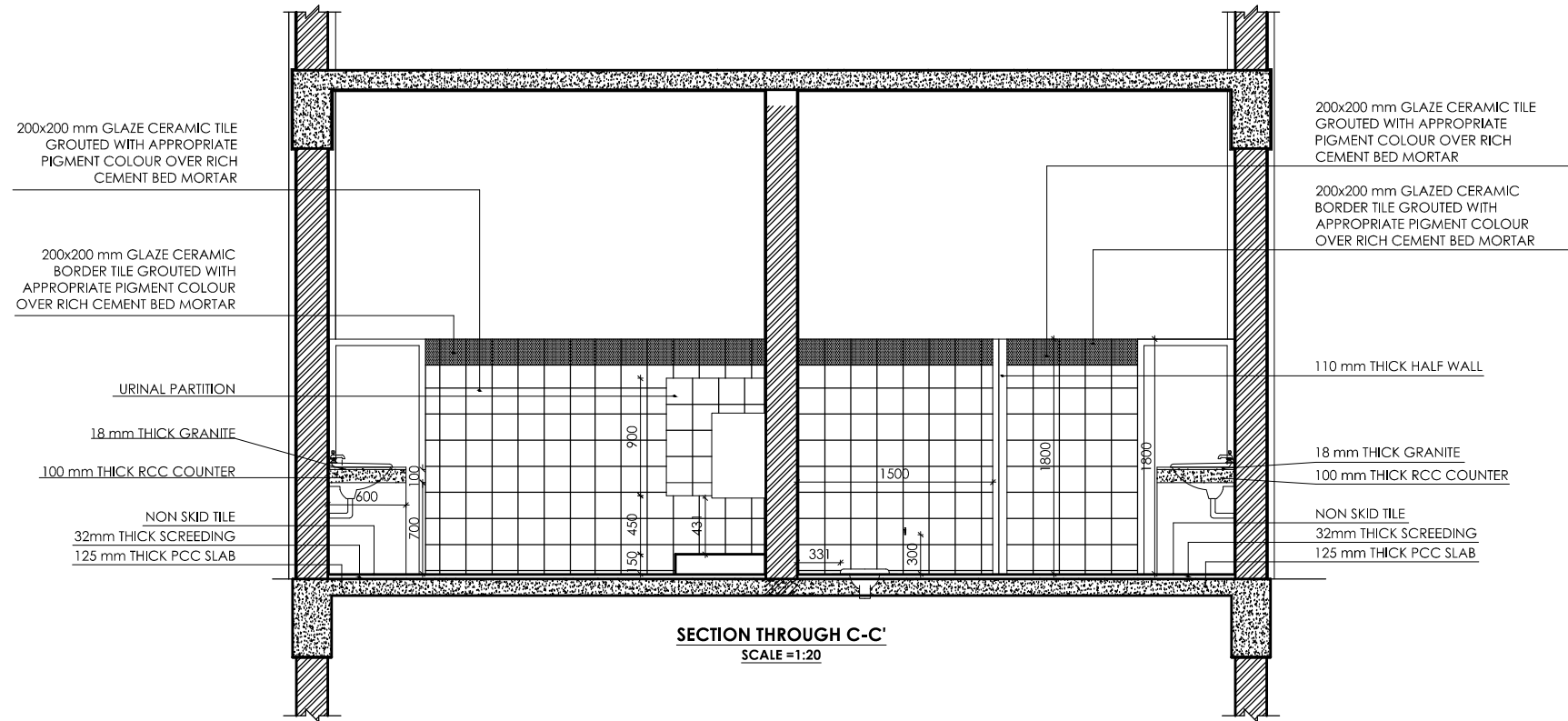
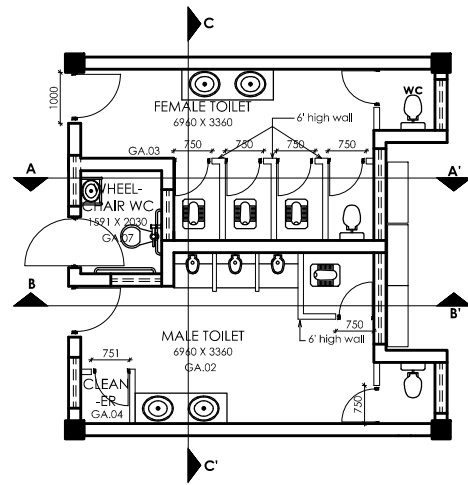

EXPANSION JOINT DETAIL AT ROOF
SCALE = 1:20

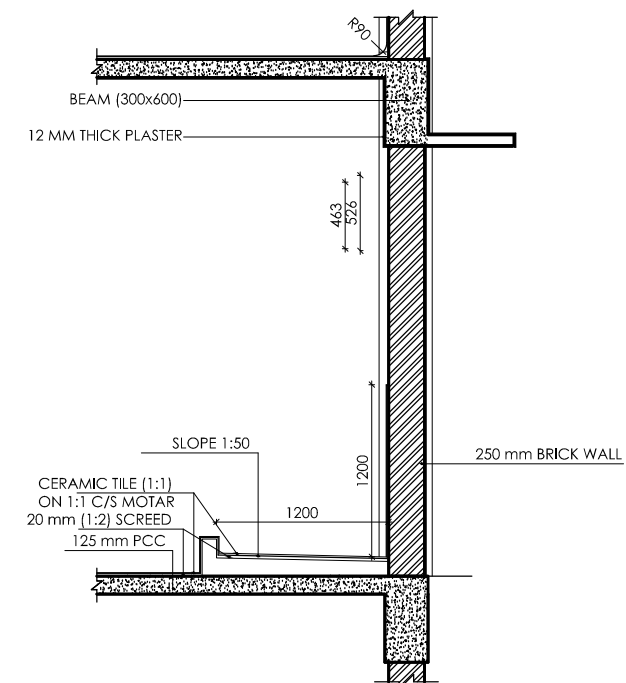

WASH AREA DETAIL AT W
SCALE = 1:20



Management Division
Department of Health Service
Ministry of Health



Health Building Infrastructure
Standard Design Drawings

Job Name:
PRIMARY HOSPITAL CLASS A
TYPE 1
Frame structure
Three storied

Scale: As shown

Date : 2070/6/7

Drawing title:
Detail

Sheet no:

AR/12

**PRIMARY HOSPITAL
CLASS A TYPE 2**

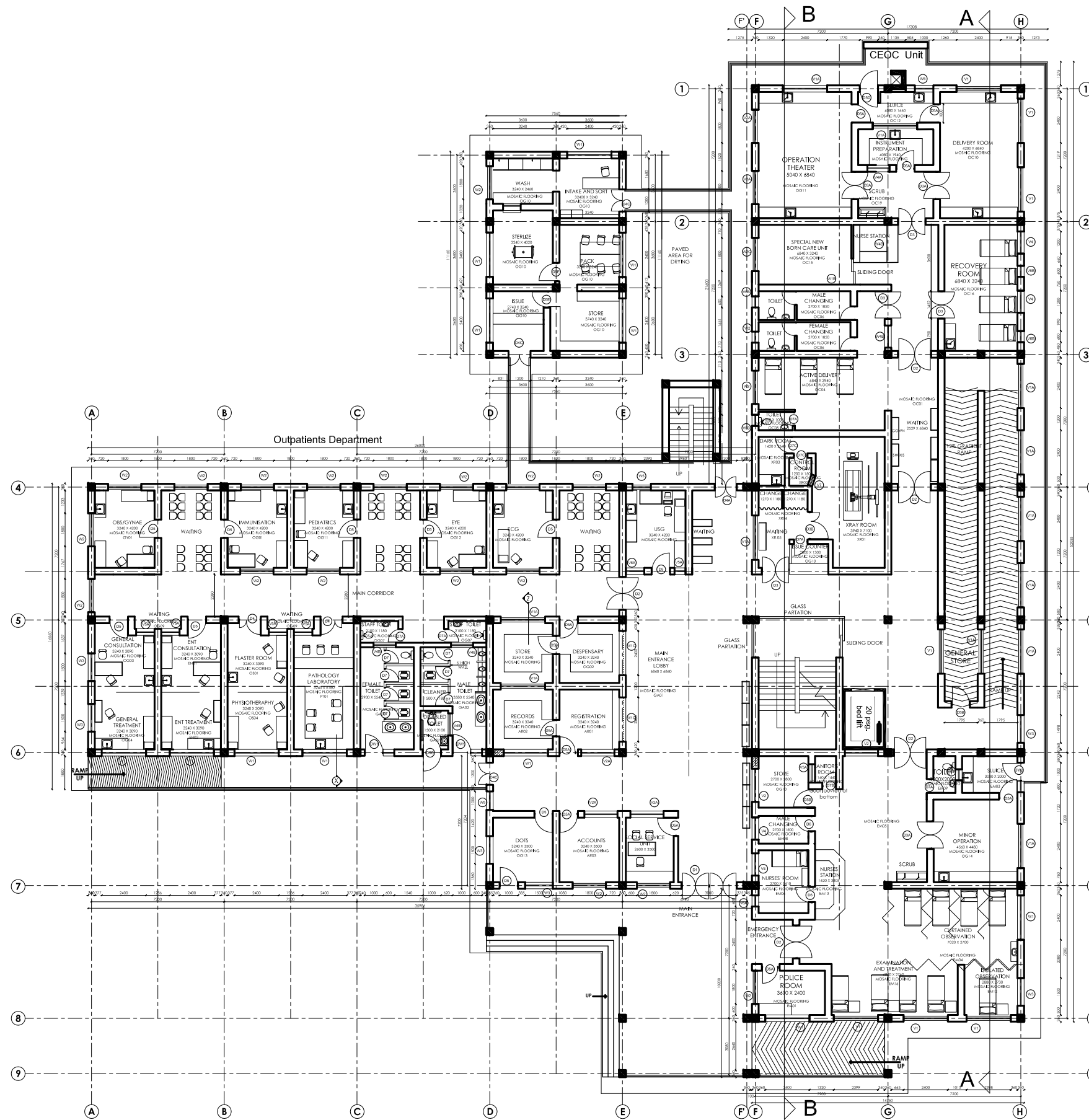

GROUND FLOOR PLAN
GROUND COVERAGE : 1520.57 m²



Management Division
Department of Health Service
Ministry of Health



Health Building Infrastructure
Standard Design Drawings

Job Name:
PRIMARY HOSPITAL CLASS "A"
TYPE 2
Frame Structure
Two Storied
Scale: 1:250
Date : 2073/11/..

Drawing title:
Ground Floor Plan
With Furniture layout

Sheet no:
AR/01

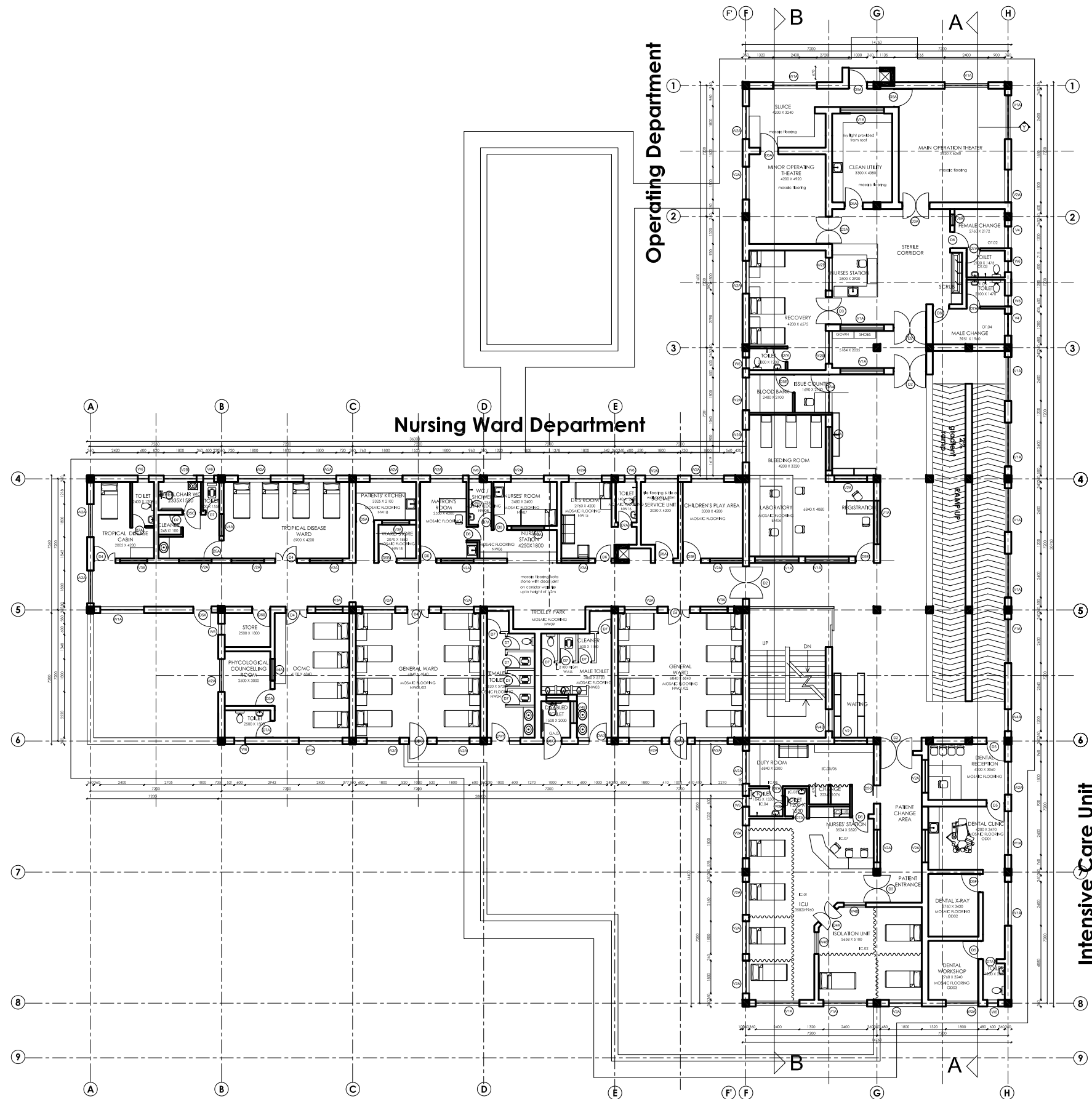

FIRST FLOOR PLAN
AREA= 1229.06 sq. m.



Management Division
Department of Health Service
Ministry of Health



Health Building Infrastructure
Standard Design Drawings

Job Name:
PRIMARY HOSPITAL CLASS "A"
TYPE 2
Frame Structure
Two Storied
Scale: 1:250
Date: 2073/11/..

Drawing title:
First Floor Plan
With Furniture layout

Sheet no:
AR/2

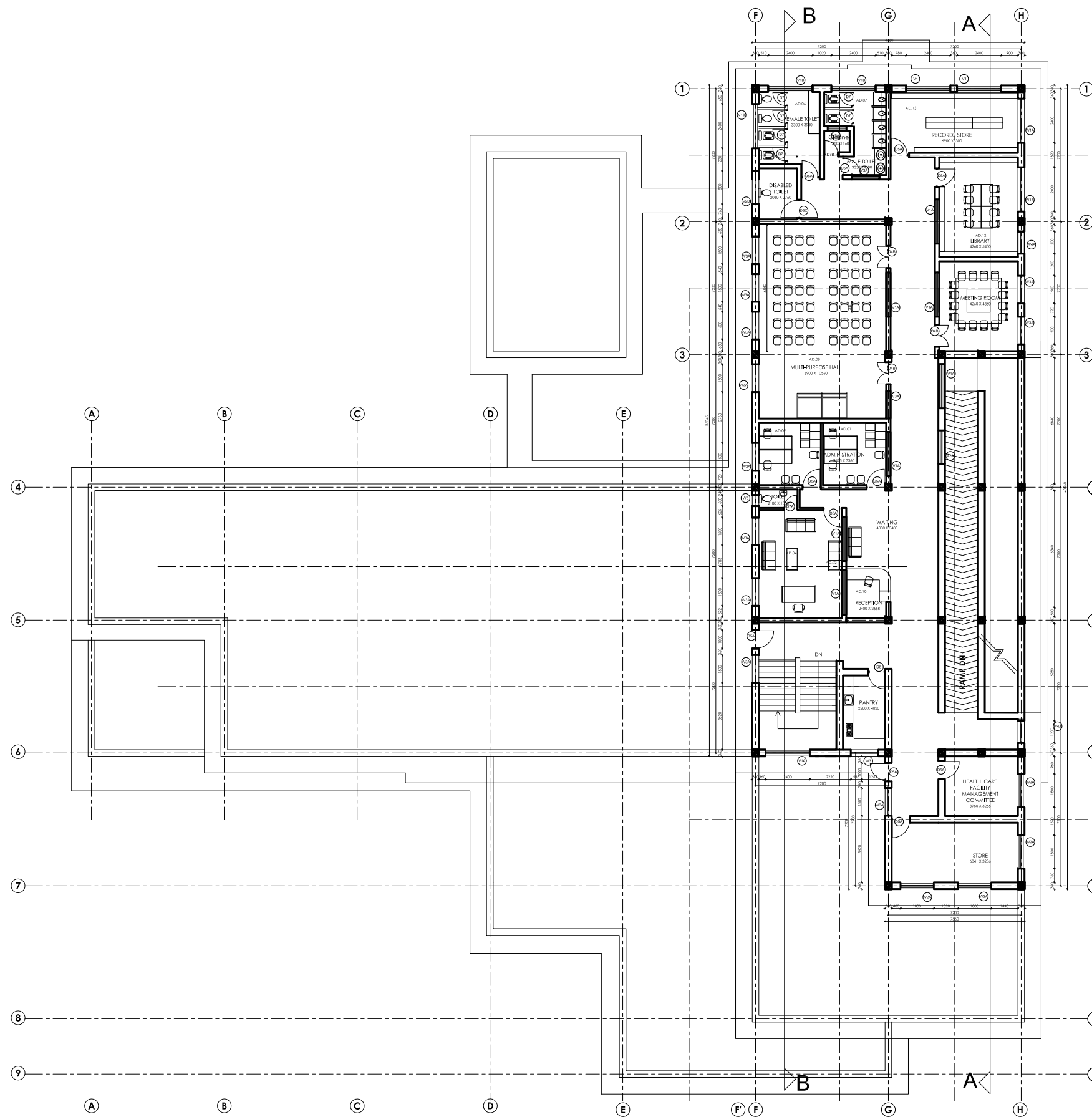

SECOND FLOOR PLAN
AREA = 591.10 sq.m.

Management Division
Department of Health Service
Ministry of Health



Health Building Infrastructure
Standard Design Drawings

Job Name:
PRIMARY HOSPITAL CLASS "A"
TYPE 2
Frame Structure
Two Storied

Scale: 1:250

Date : 2073/11/..

Drawing title:

Second Floor Plan
 With Furniture layout

Sheet no:

AR/3



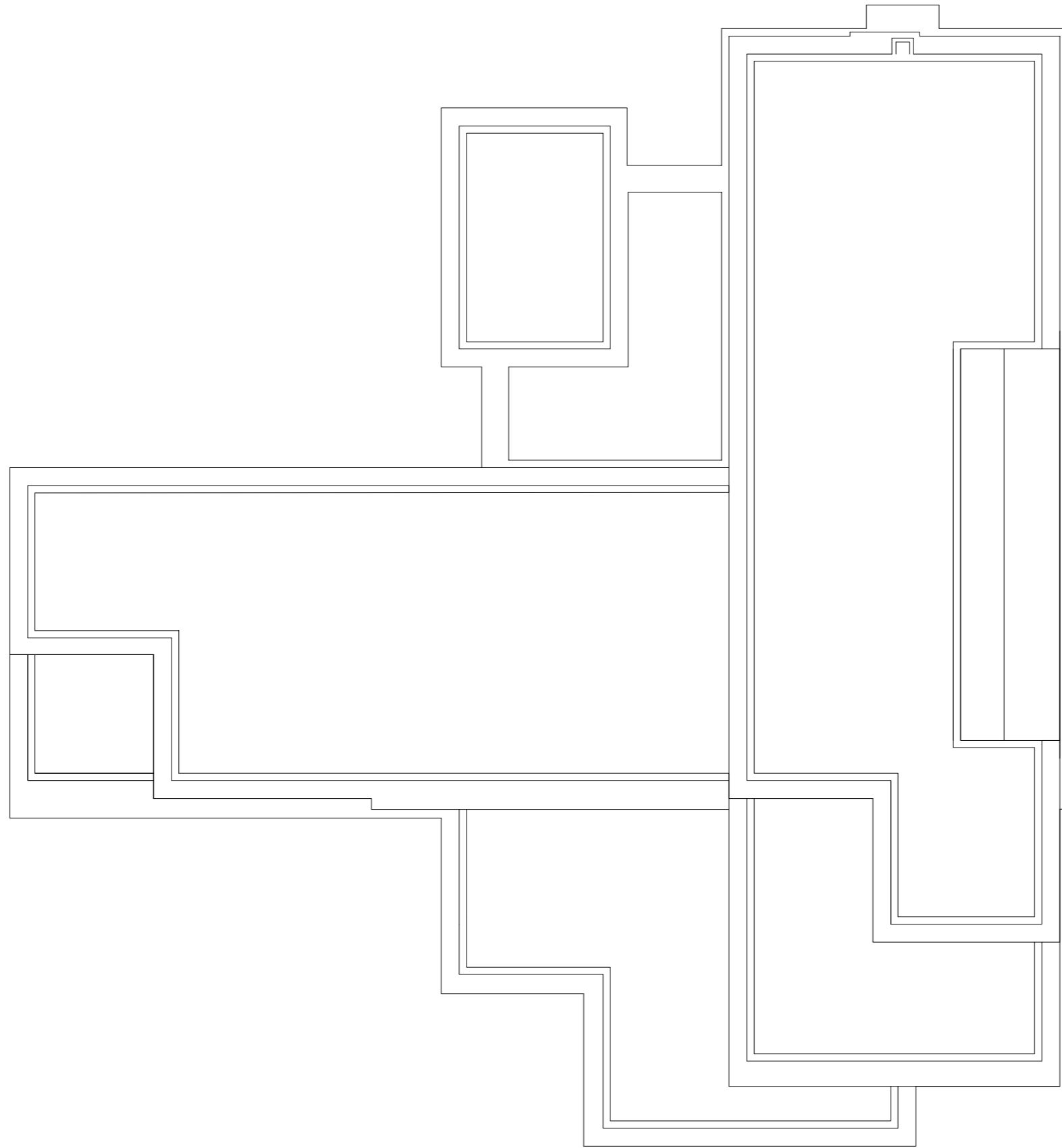

ROOF PLAN

Management Division
Department of Health Service
Ministry of Health



Health Building Infrastructure
Standard Design Drawings

Job Name:
PRIMARY HOSPITAL CLASS "A"
TYPE 2
Frame Structure
Two Storied

Scale: 1:250

Date : 2073/11/..

Drawing title:

Roof Plan

Sheet no:

AR/4



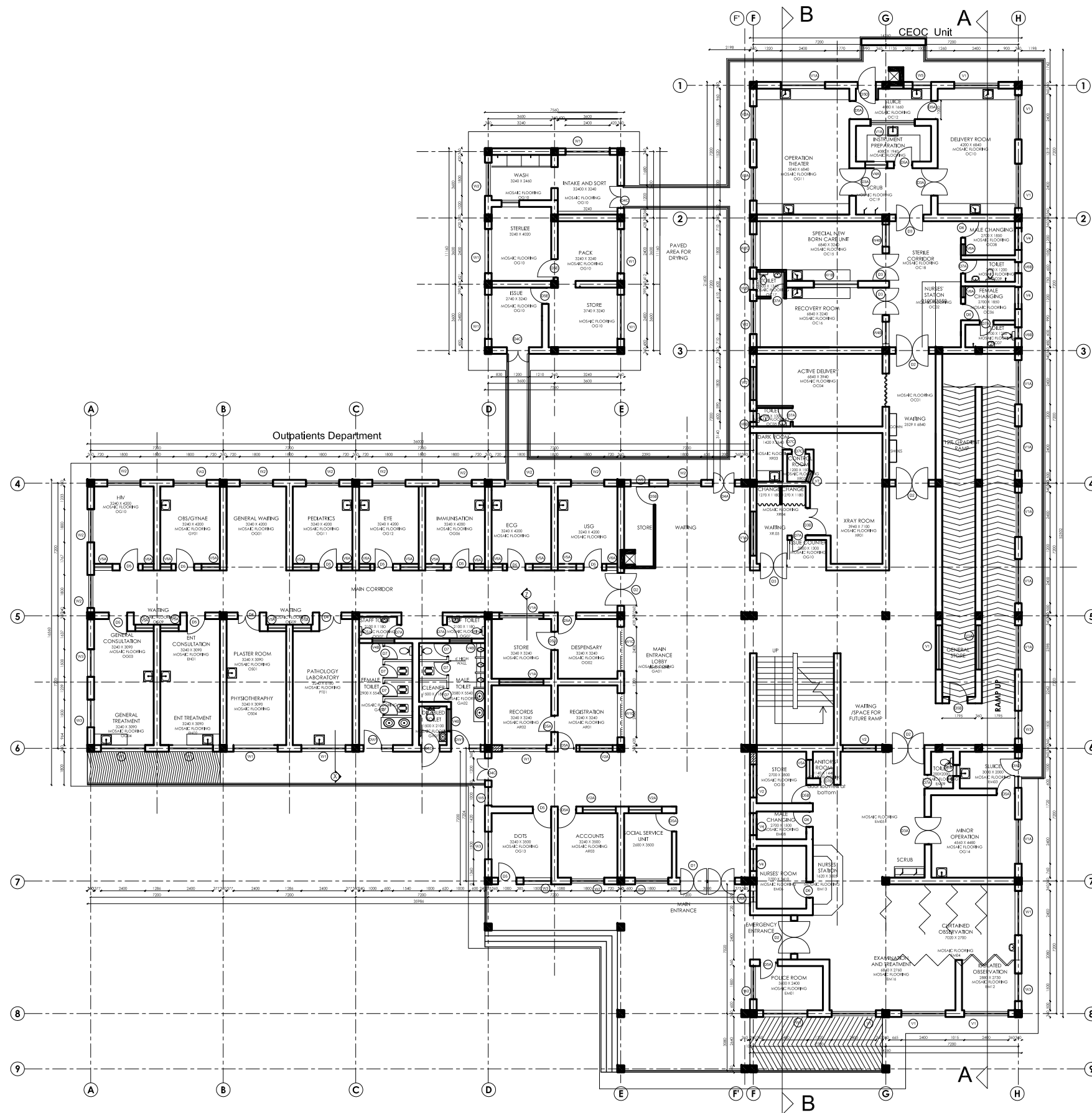

GROUND FLOOR PLAN
GROUND COVERAGE : 1520.57 m²



Management Division
Department of Health Service
Ministry of Health



Health Building Infrastructure
Standard Design Drawings

Job Name:
PRIMARY HOSPITAL CLASS "A"
TYPE 2
Frame Structure
Two Storied

Scale: 1:250

Date: 2073/11/..

Drawing title:

Ground Floor Plan
Internal Dimension

Sheet no:

AR/05

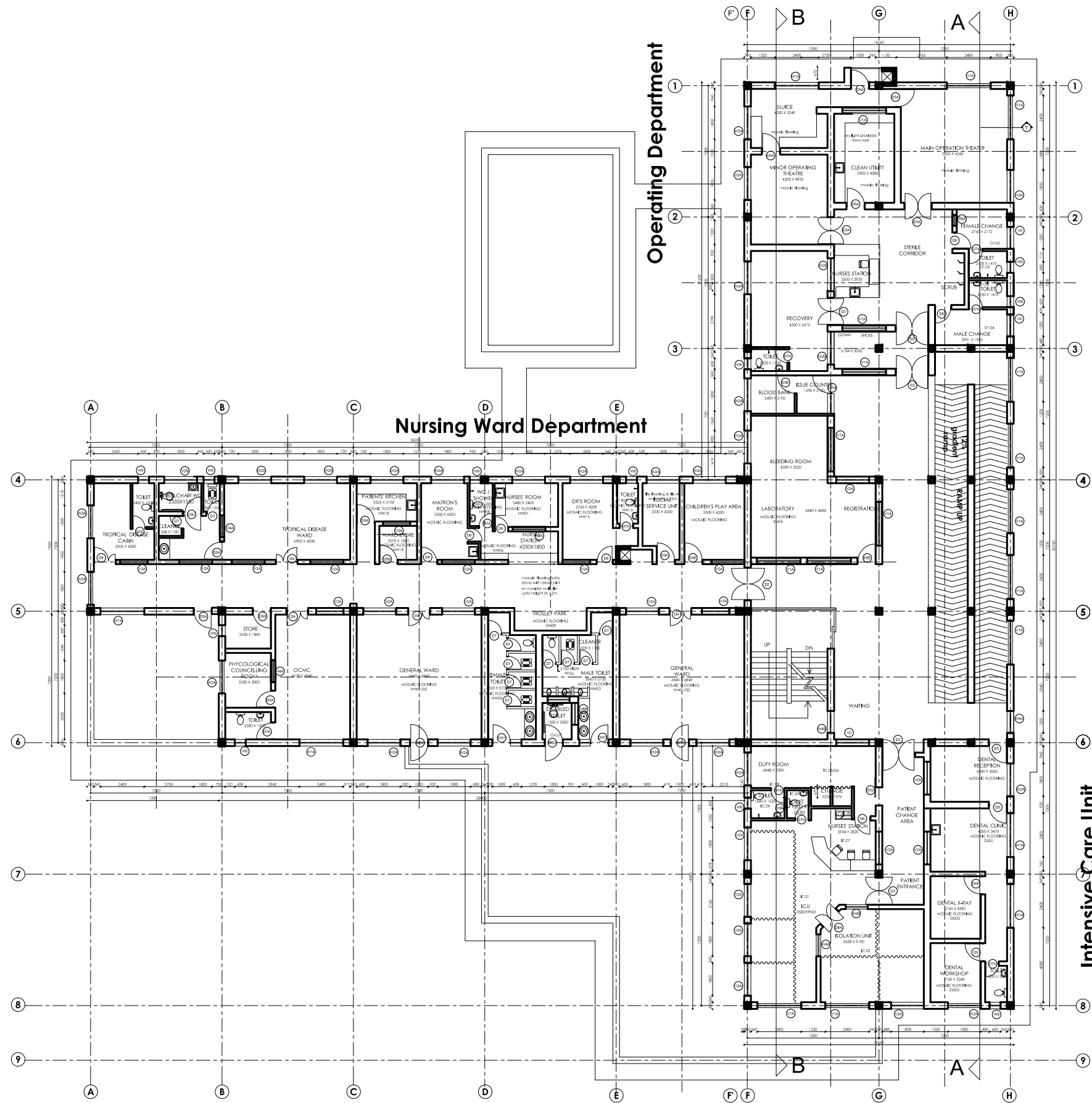

Management Division
 Department of Health Service
 Ministry of Health



Health Building Infrastructure
 Standard Design Drawings

Job Name:
 PRIMARY HOSPITAL CLASS "A"
 TYPE 2
 Frame Structure
 Two Storied

Scale: 1:250

Date : 2073/11/..

Drawing title:

First Floor Plan
 Internal Dimension

Sheet no:

AR/6

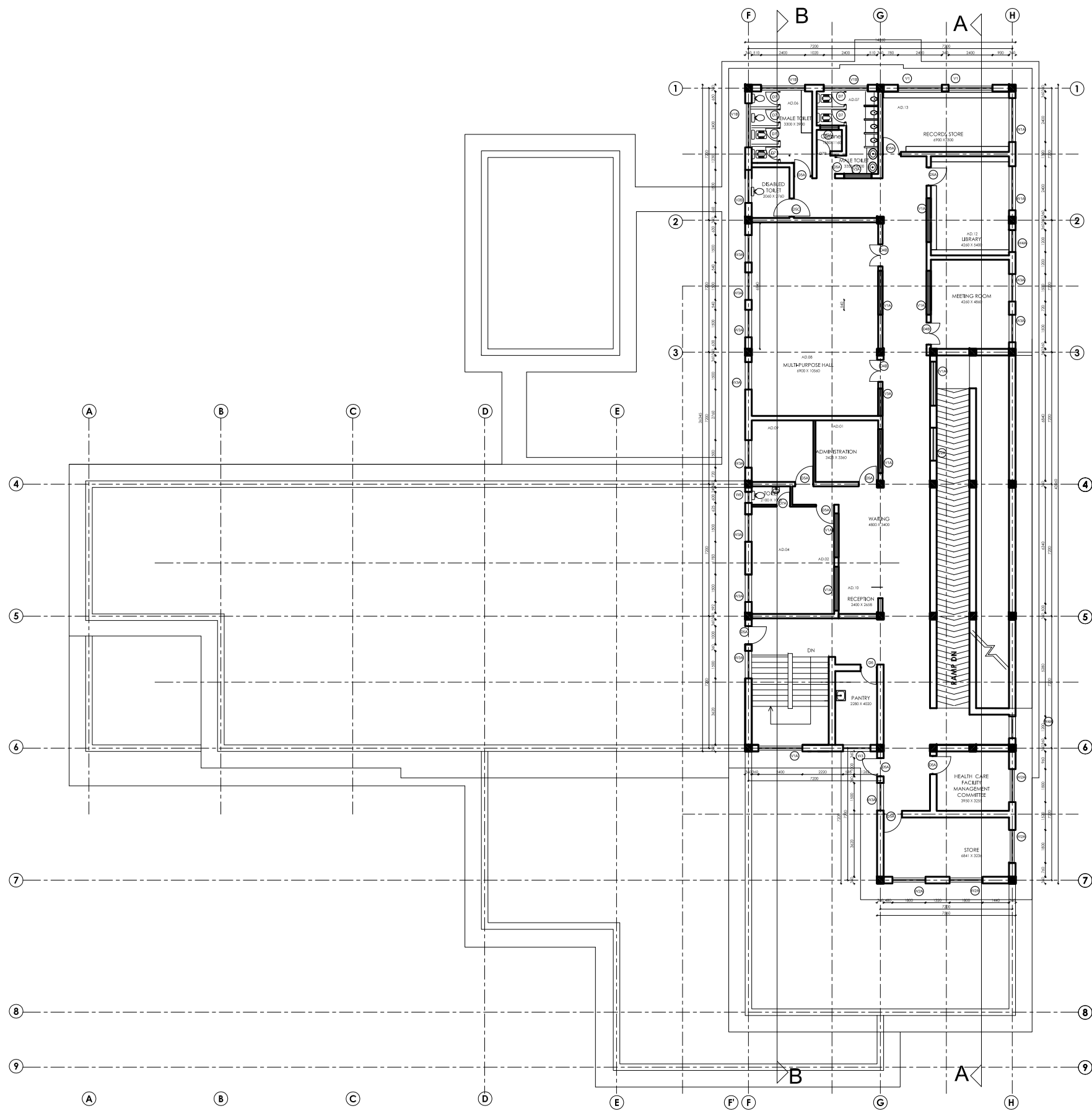

SECOND FLOOR PLAN
AREA = 591.10 sq.m.



Management Division
Department of Health Service
Ministry of Health



Health Building Infrastructure
Standard Design Drawings

Job Name:
 PRIMARY HOSPITAL CLASS "A"
 TYPE 2
 Frame Structure
 Two Storied
Scale: 1:250
Date : 2073/11/..

Drawing title:
 Second Floor Plan
 Internal Dimension

Sheet no:
AR/7

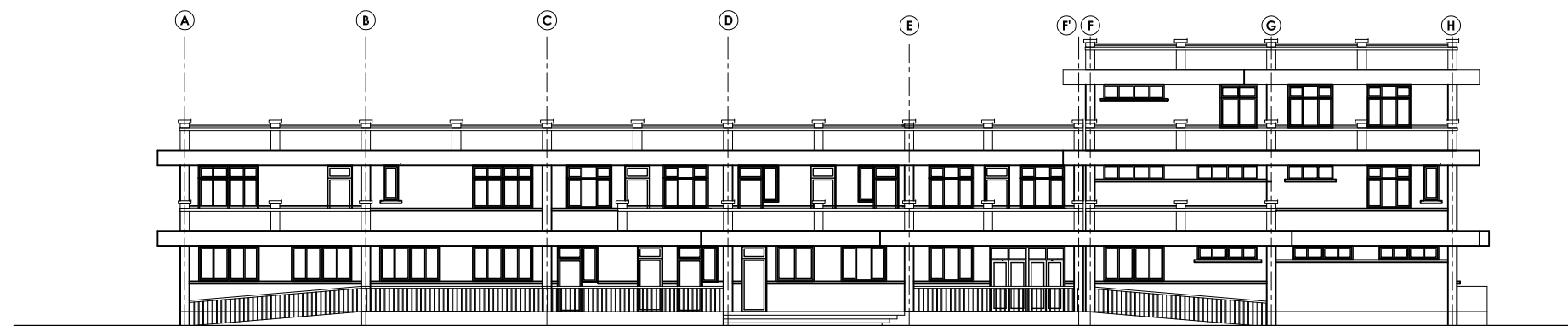

FRONT ELEVATION



BACK ELEVATION

**Management Division
Department of Health Service
Ministry of Health**



**Health Building Infrastructure
Standard Design Drawings**

Job Name:
PRIMARY HOSPITAL CLASS "A"
TYPE 2
Frame Structure
Two Storied

Scale: 1:250

Date : 2073/11/..

Drawing title:

Elevations
Front & Side

Sheet no:

AR/08



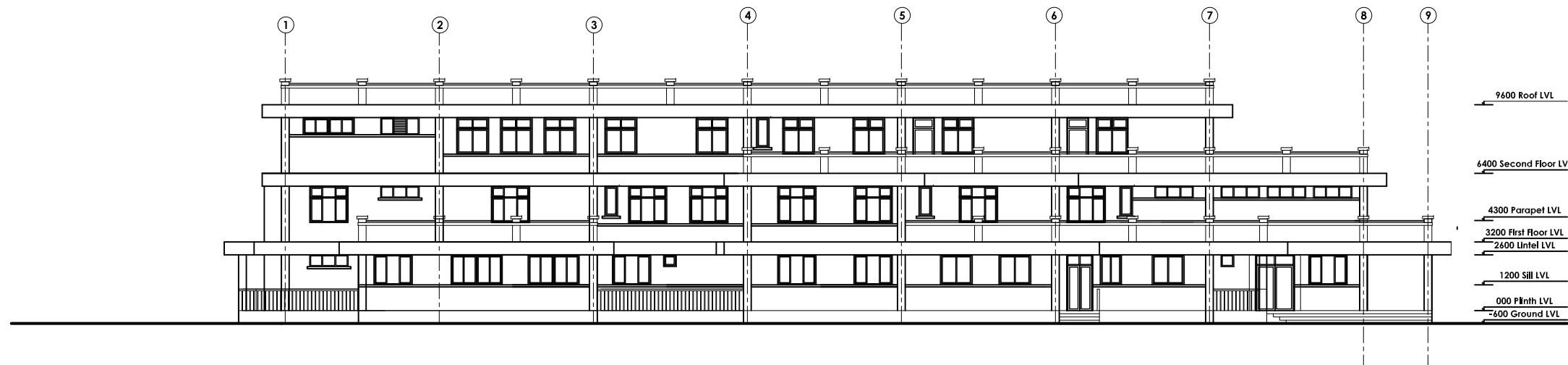

ELEVATION 1

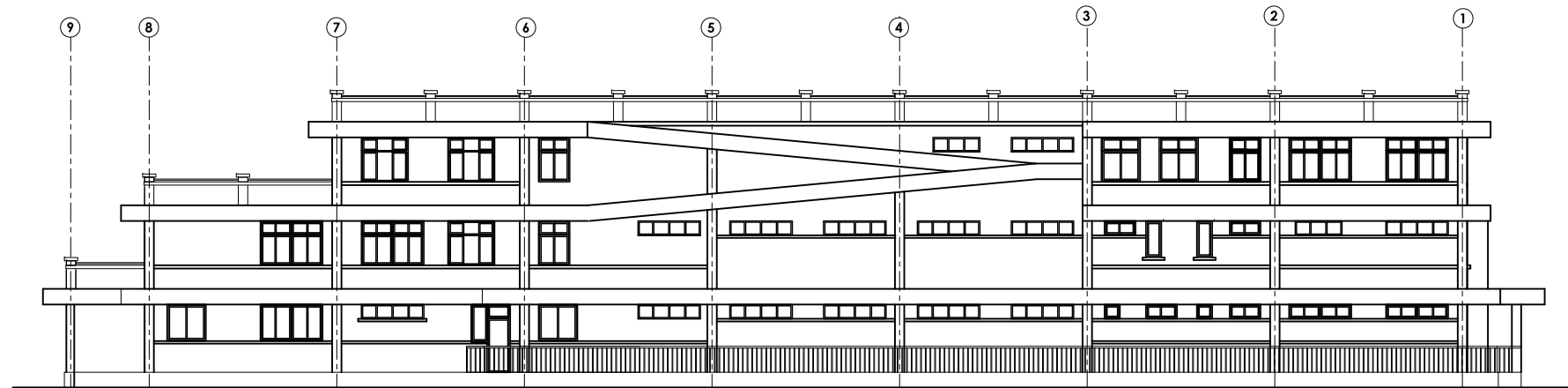

ELEVATION 2

**Management Division
Department of Health Service
Ministry of Health**



**Health Building Infrastructure
Standard Design Drawings**

Job Name:
PRIMARY HOSPITAL CLASS "A"
TYPE 2
Frame Structure
Two Storied

Scale: 1:250

Date : 2073/11/..

Drawing title:

Elevations
Back & Side

Sheet no:

AR/09



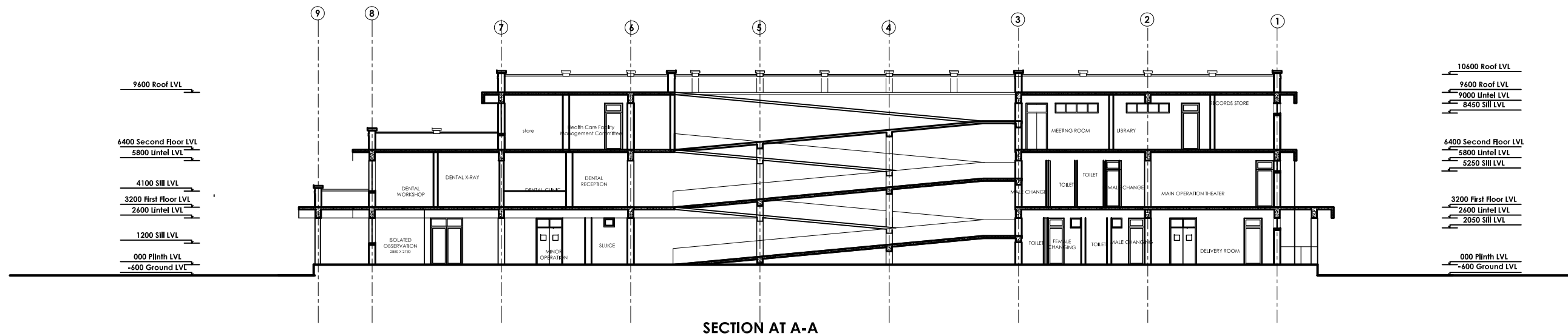

SECTION AT A-A

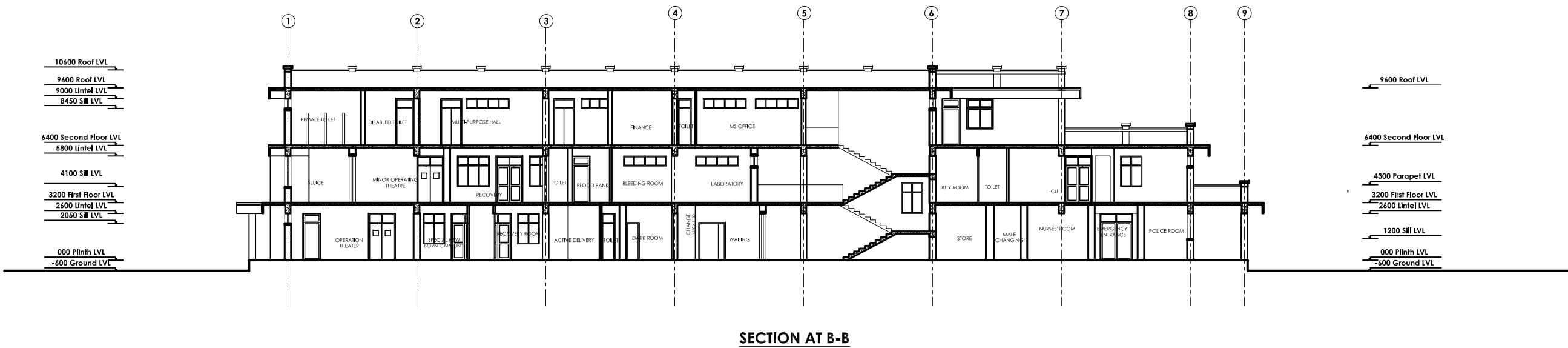

SECTION AT B-B



Management Division
Department of Health Service
Ministry of Health



Health Building Infrastructure
Standard Design Drawings

Job Name:
PRIMARY HOSPITAL CLASS "A"
TYPE 2
Frame Structure
Two Storied
Scale: as shown
Date : 2073/11/..

Drawing title:
Sections

Sheet no:
AR/10

OPENING TYPE	D1	D2	D3	D3A	D3B	D4
SHAPE AND SIZE						
QUANTITY	1	9	6	5	1	7
SPECIFICATION	Double Swing, upper half- transparent glass, lower half panel	Double Swing, upper half- transparent glass, lower half panel	Double Swing, upper half- transparent glass, lower half panel	Double Swing, upper half- transparent glass, lower half panel; OT, Delivery room	Lead lined Door in X-Ray Room	flush door with viewing pane
LOCATION	Main Door	Corridor, Emergency Main Door	Labour, Recovery room, Main Entrance of ICU, new born care unit	OT, Delivery	X-Ray	Wards, Plaster, Surgery, Physiotherapy Rm

OPENING TYPE	D4A	D4B	D4C	D5	D5A	D5B
SHAPE AND SIZE						
QUANTITY	2	3	3	11	30	4
SPECIFICATION	Double Swing, upper half- transparent glass, lower half panel	Panned Door	upper half glass, lower half panned door	Panned with viewing pane in OPD	Panned door Toilet Main door, Office, Patient Kitchen, Inner sluice door, Clean Utility	Panned door with louvered ventilation
LOCATION	Back exit of OPD, isolation ICU	Meeting Room and multipurpose Hall	exit towards common toilets, CSSD	OPD		Store

OPENING TYPE	D5C	D5D	D5E	D5F	D5G	D6
SHAPE AND SIZE						
QUANTITY	6	1	3	1	1	12
SPECIFICATION	Double Swing, Panned door	Double Swing, upper half Glass, lower half panned door in	Upper half Glass, lower half panned door, in	Lead lined Door	Sliding Panned Door	Panned door
LOCATION	Disabled Toilet, towards verandah in ward	Outer Sluice door	Autoclave, Blood Bank	Denal X-Ray	Duty Room in ICU	Duty Room, Changing room, Pantry

OPENING TYPE	DW1	DW2	DW3	DW4	V1	V1A
SHAPE AND SIZE						
QUANTITY	3	1	1	1	9	36
SPECIFICATION	Panned Door with window	upper half glass, lower half panned door	Panned Door with louvered window	Panned door with sliding window	SLIDING	FIXED
LOCATION	Common toilet	sluice outer door	Common toilet	Blood bank counter	GROUND AND SECOND FLOOR	GROUND FIRST AND SECOND FLOOR
OPENING TYPE	V1B	V2	V2A	V2B	V3A	V4
SHAPE AND SIZE						
QUANTITY	3	3	22	2	7	6
SPECIFICATION	SLIDING	SLIDING	FIXED	LOUVERED		SLIDING
LOCATION	SECOND FLOOR	GROUND AND FIRST FLOOR	GROUND FIRST AND SECOND FLOOR	FIRST AND SECOND FLOOR	FIRST AND SECOND FLOOR	GROUND AND FIRST FLOOR
OPENING TYPE	V4A	V4B	V5A	V6A	V6B	V6C
SHAPE AND SIZE						
QUANTITY	2	5	13	11	6	1
SPECIFICATION	FIXED	LOUVERED	FIXED	FIXED	MOVABLE	FIXED
LOCATION	FIRST FLOOR	GROUND AND FIRST FLOOR	GROUND AND SECOND FLOOR	GROUND AND FIRST FLOOR	GROUND AND FIRST FLOOR	GROUND FLOOR



Management Division
Department of Health Service
Ministry of Health



Health Building Infrastructure
Standard Design Drawings

Job Name:
PRIMARY HOSPITAL CLASS "A"
TYPE 2
Frame Structure
Two Storied

Scale: 1:10,1:50

Date: 2073/11/..

Drawing title:

TYPICAL
WINDOW DETAIL

Sheet no:

AR/12

OPENING TYPE	DW1	DW2	DW3	DW4	V1	V1A
SHAPE AND SIZE						
QUANTITY	3	1	1	1	9	36
SPECIFICATION	Panned Door with window	upper half glass, lower half panned door	Panned Door with louvered window	Panned door with sliding window	SLIDING	FIXED
LOCATION	Common toilet	sluice outer door	Common toilet	Blood bank counter	GROUND AND SECOND FLOOR	GROUND FIRST AND SECOND FLOOR
OPENING TYPE	V1B	V2	V2A	V2B	V3A	V4
SHAPE AND SIZE						
QUANTITY	3	3	22	2	7	6
SPECIFICATION	SLIDING	SLIDING		LOUVERED		SLIDING
LOCATION	SECOND FLOOR	GROUND AND FIRST FLOOR	GROUND FIRST AND SECOND FLOOR	FIRST AND SECOND FLOOR	FIRST AND SECOND FLOOR	GROUND AND FIRST FLOOR
OPENING TYPE	V4A	V4B	V5A	V6A	V6B	V6C
SHAPE AND SIZE						
QUANTITY	2	5	13	11	6	1
SPECIFICATION	FIXED	LOUVERED	FIXED	FIXED	MOVABLE	FIXED
LOCATION	FIRST FLOOR	GROUND AND FIRST FLOOR	GROUND AND SECOND FLOOR	GROUND AND FIRST FLOOR	GROUND AND FIRST FLOOR	GROUND FLOOR



**Management Division
Department of Health Service
Ministry of Health**



**Health Building Infrastructure
Standard Design Drawings**

Job Name:
PRIMARY HOSPITAL CLASS "A"
TYPE 2
Frame Structure
Two Storied

Scale: 1:10, 1:50

Date: 2073/11/..

Drawing title:

TYPICAL
WINDOW DETAIL

Sheet no:

AR/13

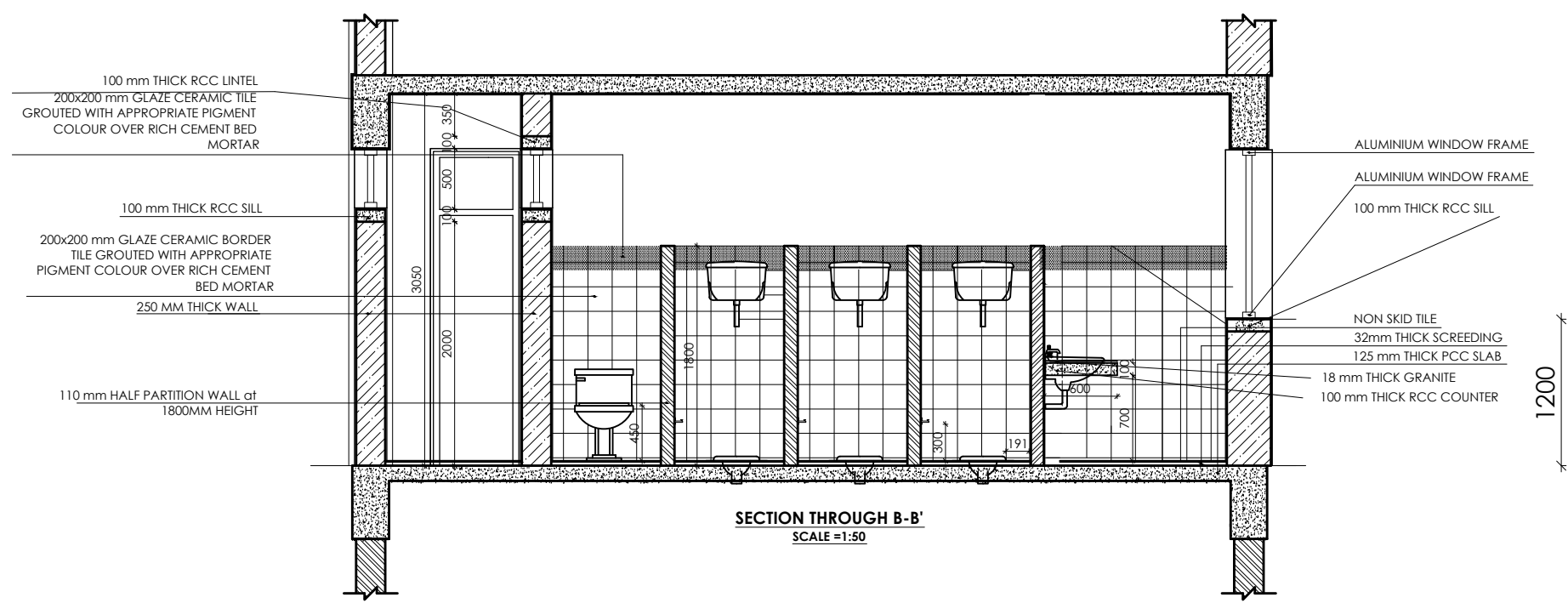
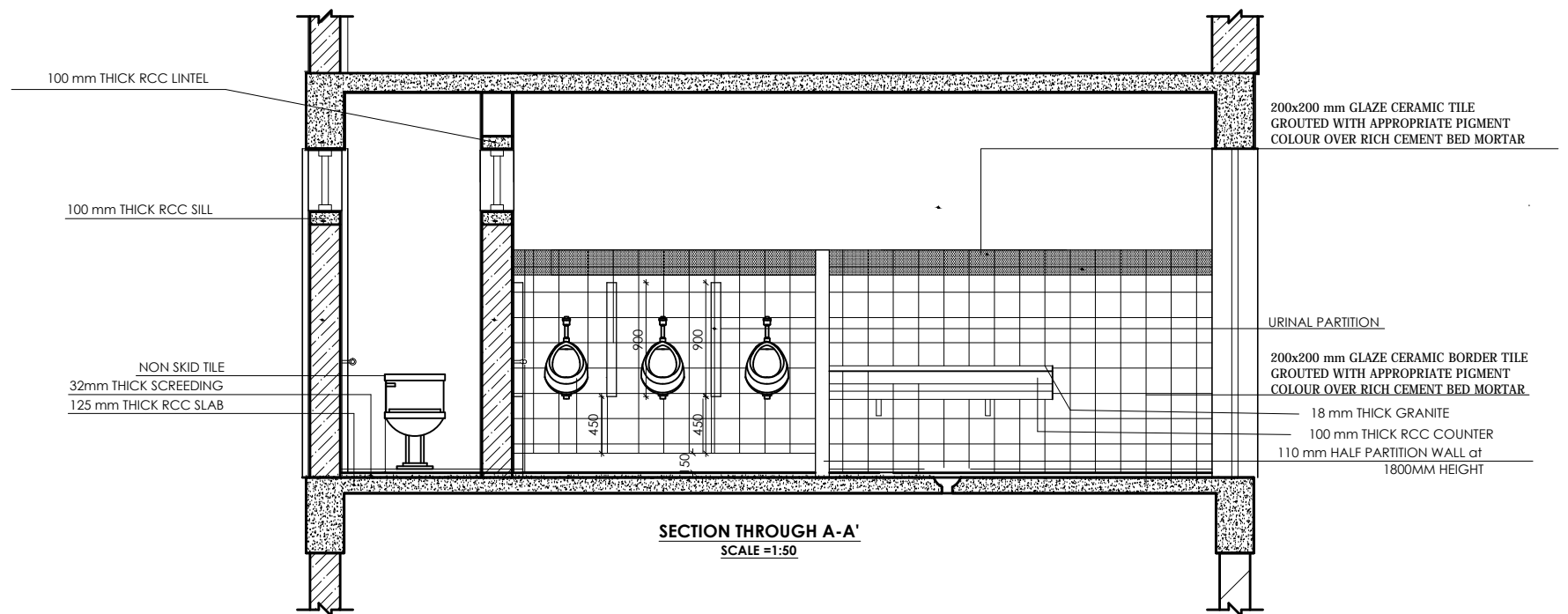
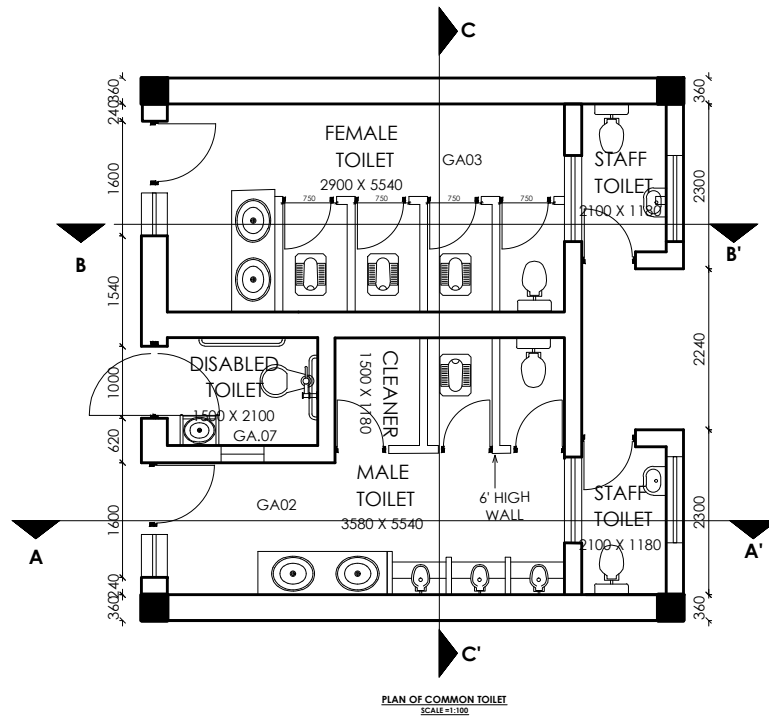

Management Division
Department of Health Service
Ministry of Health



Health Building Infrastructure
Standard Design Drawings

Job Name:
PRIMARY HOSPITAL CLASS "A"
TYPE 2
Frame Structure
Two Storied

Scale: 1:50

Date: 2073/11/..

Drawing title:
Details

Sheet no:
AR/14

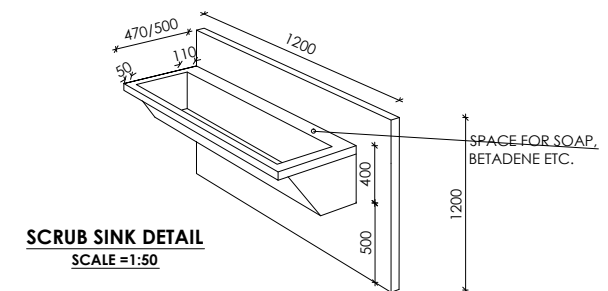
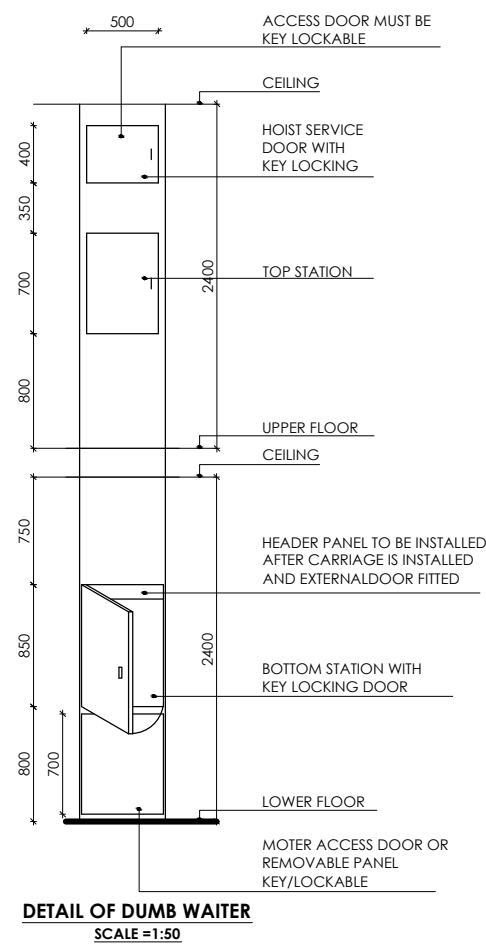
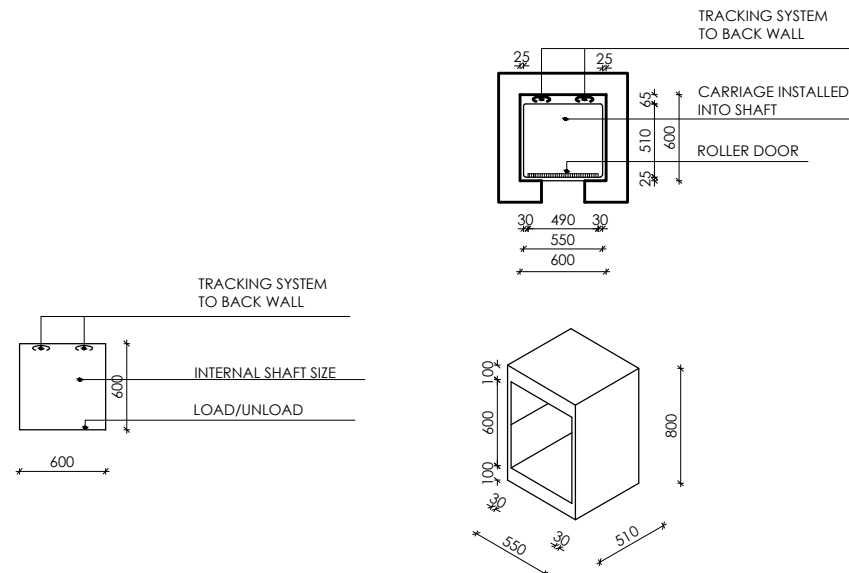
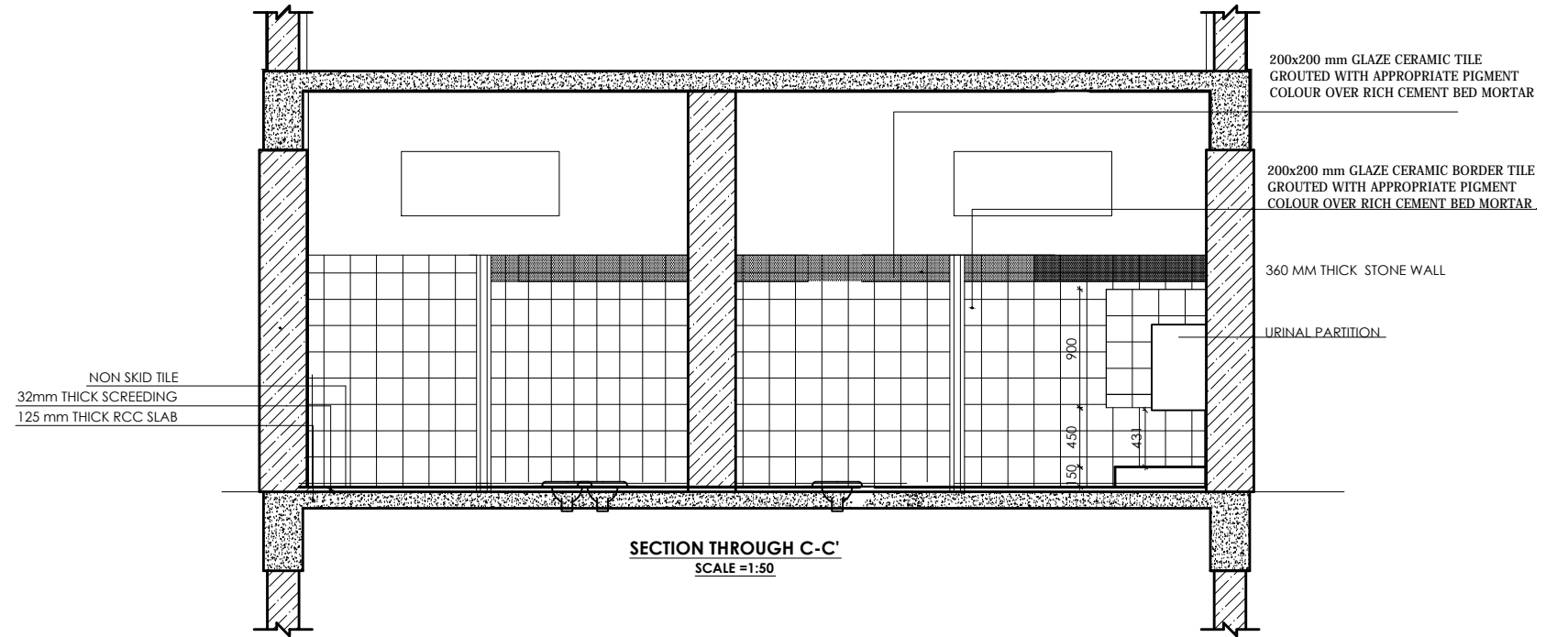
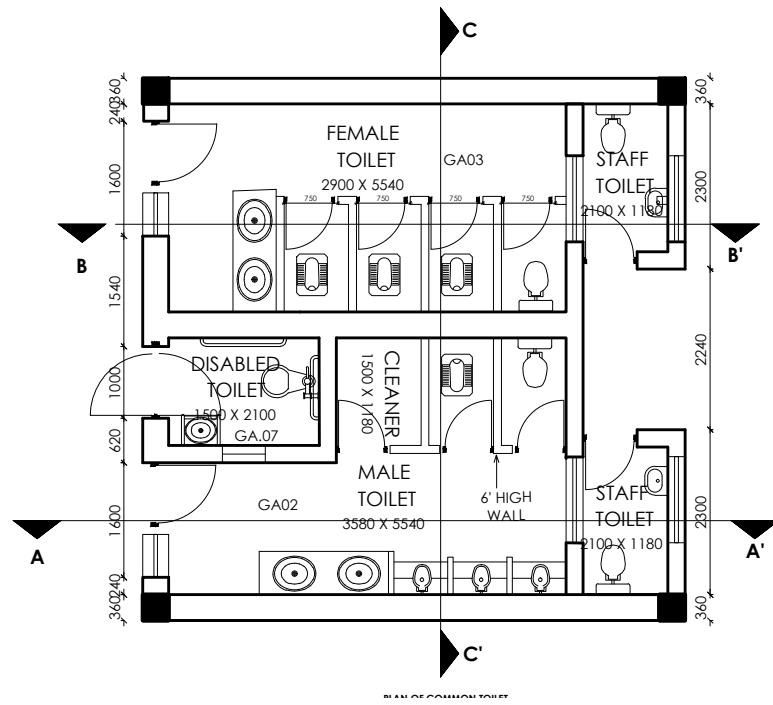

Management Division
Department of Health Service
Ministry of Health



Health Building Infrastructure
Standard Design Drawings

Job Name:
PRIMARY HOSPITAL CLASS "A"
TYPE 2
Frame Structure
Two Storied

Scale: 1:50

Date : 2073/11/..

Drawing title:

Details

Sheet no:

AR/15

**PRIMARY HOSPITAL
CLASS A TYPE 3**

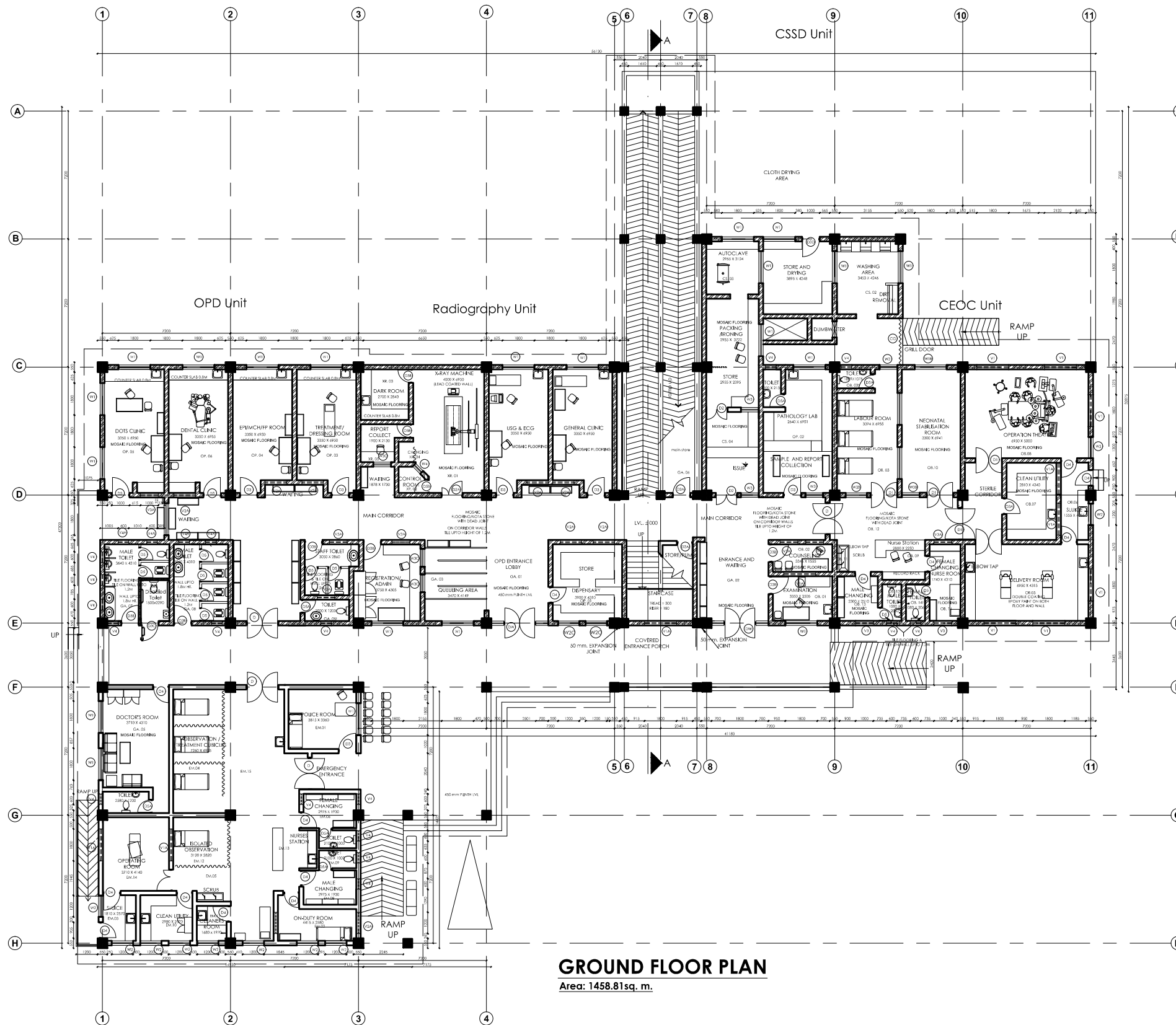

Management Division
Department of Health Service
Ministry of Health & Population



Health Building Infrastructure
Standard Design Drawings

Job Name:
PRIMARY HOSPITAL CLASS A
TYPE 3
RCC Frame Structure
Three Storied

Scale: 1:250

Date: 2070/6/7

Drawing title:
Ground Floor
Plan w/
Furniture Layout

Sheet no:

AR/01

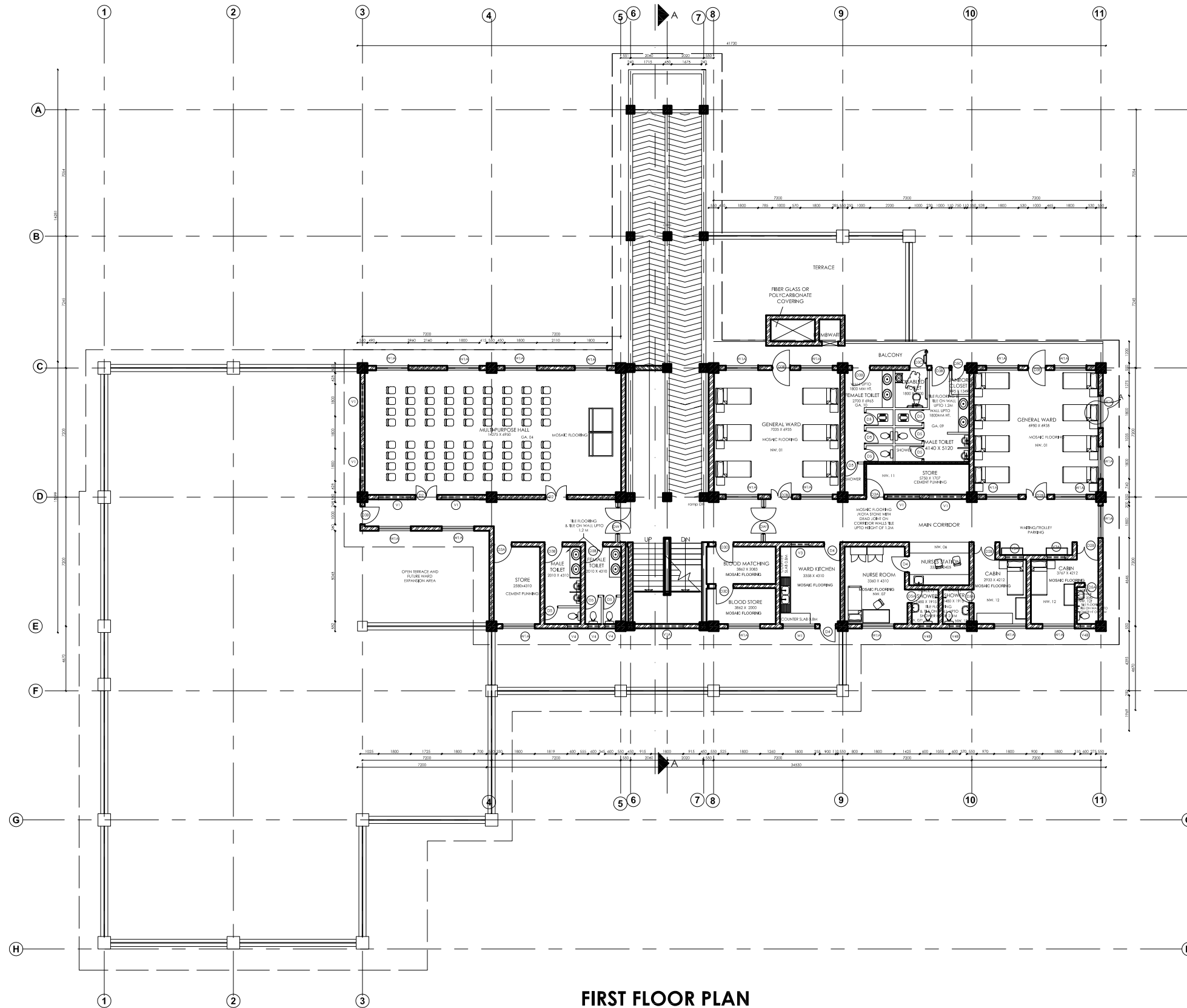

FIRST FLOOR PLAN
659.14



Management Division
Department of Health Service
Ministry of Health & Population



Health Building Infrastructure
Standard Design Drawings

Job Name:
PRIMARY HOSPITAL CLASS A
TYPE 3
RCC Frame Structure (Brick Masonry)
Three Storied

Scale: 1:250

Date: 2070/6/7

Drawing title:
First Floor Plan
without int.
dimension

Sheet no:
AR/02

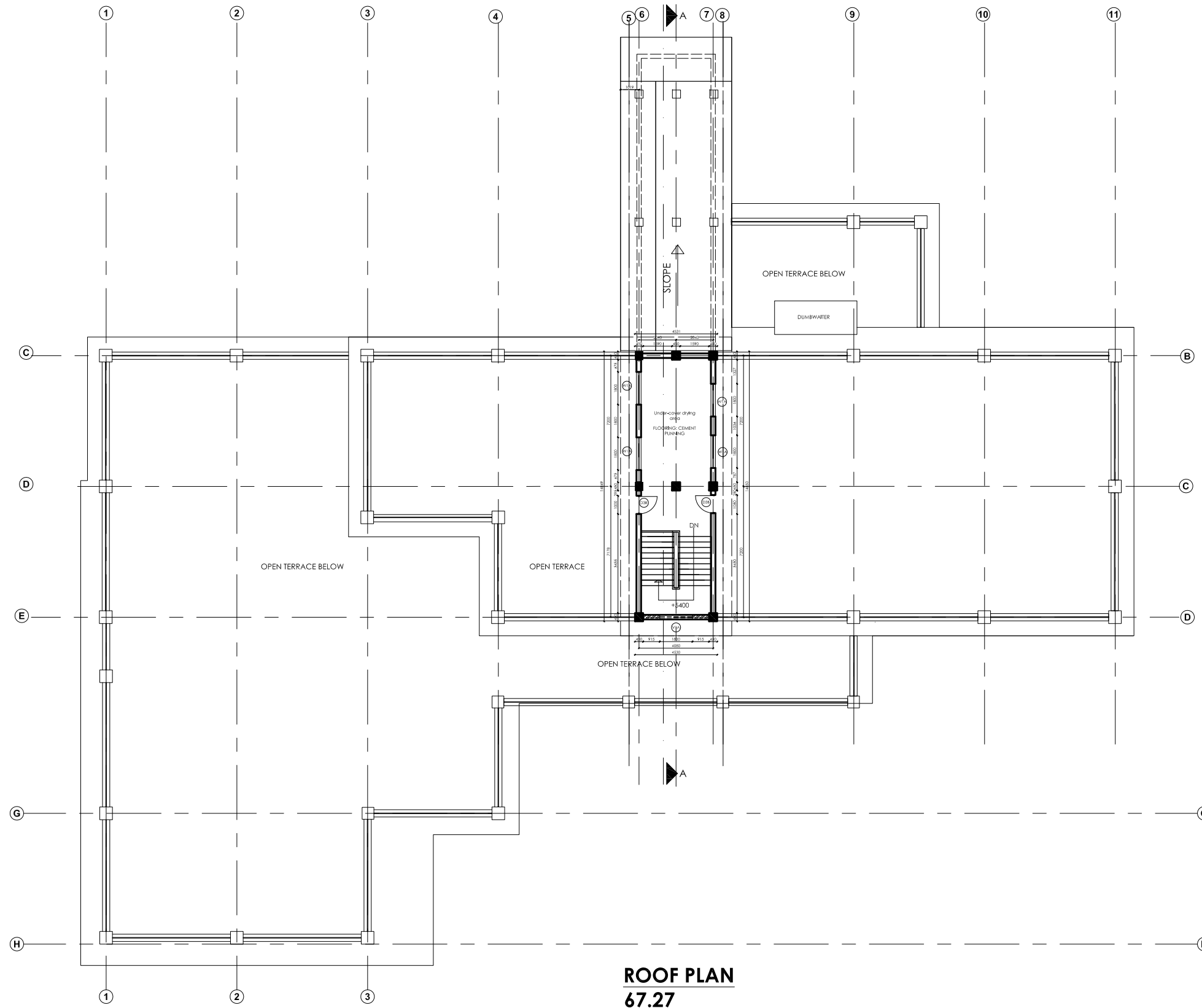

Management Division
Department of Health Service
Ministry of Health & Population



Health Building Infrastructure
Standard Design Drawings

Job Name:
PRIMARY HOSPITAL CLASS A
TYPE 3
RCC Frame Structure (Brick Masonry)
Three Storied

Scale: 1:250

Date: 2070/6/7

Drawing title:
Top Floor Plan

Sheet no:

AR/03

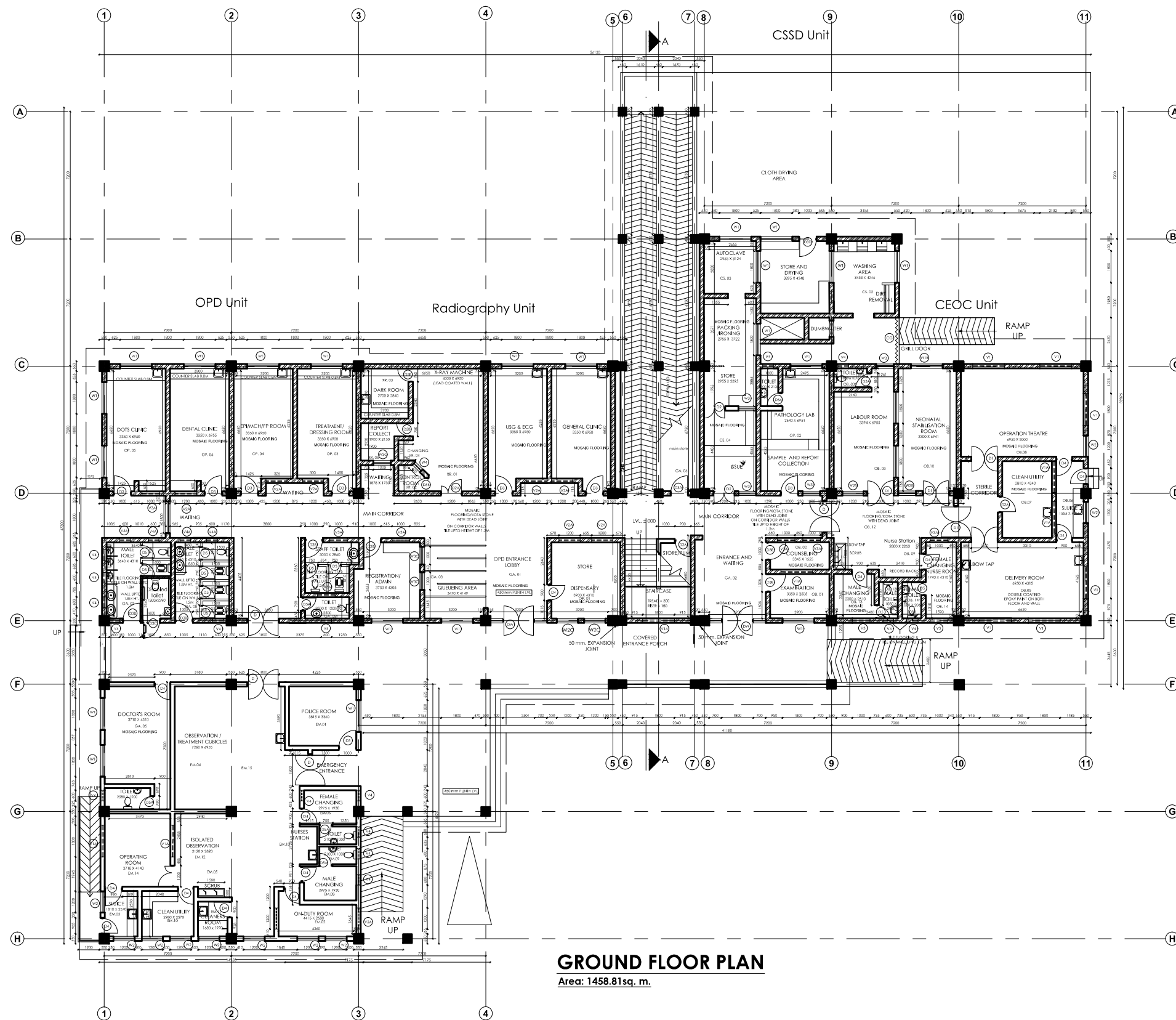

Management Division
Department of Health Service
Ministry of Health & Population



Health Building Infrastructure
Standard Design Drawings

Job Name:
PRIMARY HOSPITAL CLASS A
TYPE 3
RCC Frame Structure
Three Storied

Scale: 1:250

Date: 2070/6/7

Drawing title:
Ground Floor
Plan w/
Furniture Layout

Sheet no:

AR/04

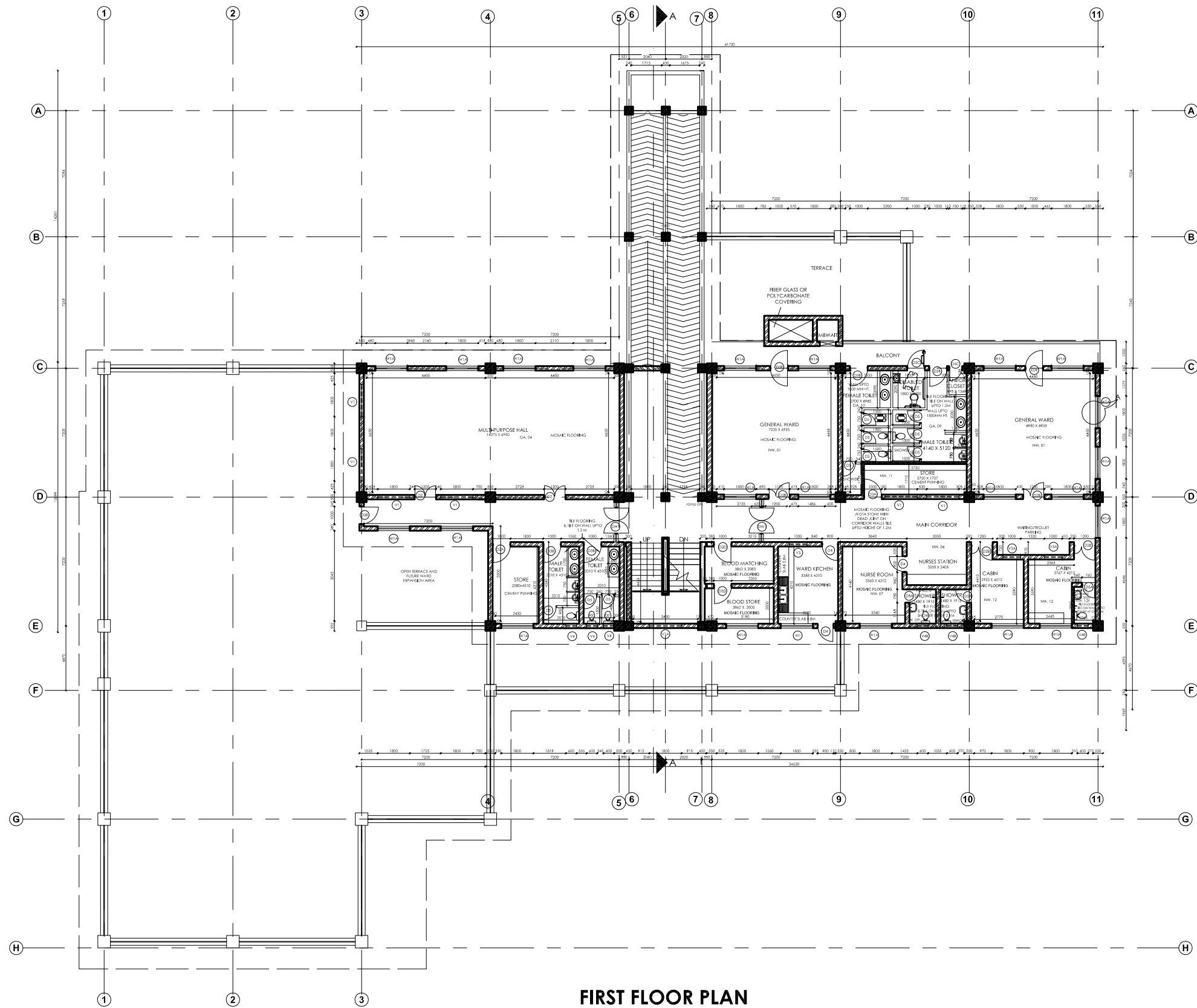

FIRST FLOOR PLAN
659.14

Management Division
Department of Health Service
Ministry of Health & Population



Health Building Infrastructure
Standard Design Drawings

Job Name:
PRIMARY HOSPITAL CLASS A
TYPE 3
RCC Frame Structure (Brick Masonry)
Three Storied

Scale: 1:250

Date: 2070/6/7

Drawing title:
First Floor Plan
without int.
dimension

Sheet no:

AR/05



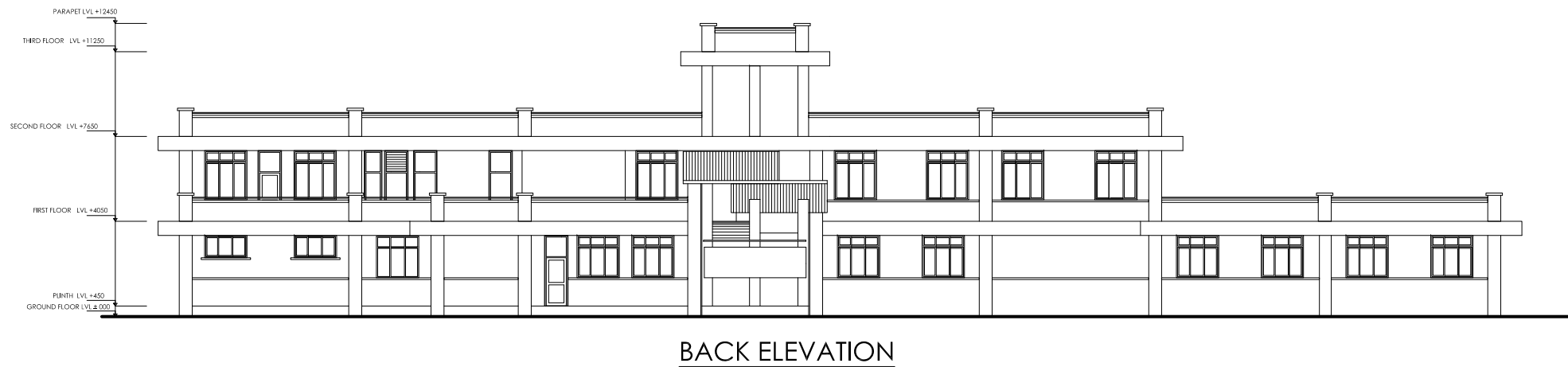

**Management Division
Department of Health Service
Ministry of Health & Population**



**Health Building Infrastructure
Standard Design Drawings**

Job Name:
PRIMARY HOSPITAL CLASS A
TYPE 3
RCC Frame Structure (Brick Masonry)
Three Storied

Scale: 1:250

Date : 2070/6/7

Drawing title:
Elevations

Sheet no:
AR/06

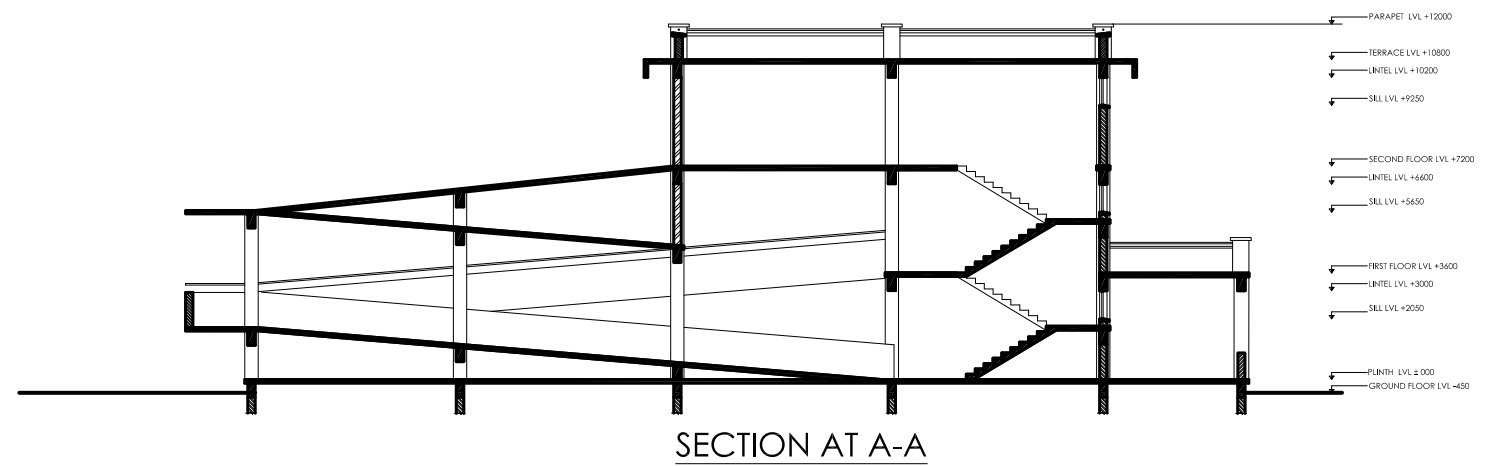

Management Division
Department of Health Service
Ministry of Health & Population



Health Building Infrastructure
Standard Design Drawings

Job Name:
PRIMARY HOSPITAL CLASS A
TYPE 3
RCC Frame Structure (Brick Masonry)
Three Storied

Scale: 1:250

Date : 2070/6/7

Drawing title:
Elevation and
Section

Sheet no:

AR/07

OPENING TYPE	D	D1	D2	D2A	D2B	D3
SHAPE AND SIZE						
QUANTITY	4	4	4	1	4	8
SPECIFICATION	upper half- transparent glass, lower half panel; both way swing	flush door with viewing pane ; both way swing	Flush Door	Lead lined Door	flush door with viewing pane	flush door with viewing pane
LOCATION	Corridor	Delivery, Labour Room, Procedure	Multipurpose Hall, sterilised items out	X-Ray	Wards	OPD
OPENING TYPE	D3A	D3B	D3C	D3D	D3E	D4
SHAPE AND SIZE						
QUANTITY	5	15	3	3	2	17
SPECIFICATION	Flush door	Flush door	Double Swing flush door	Upper half Glass, lower half paneled door	Double Swing Paneled door	flush door
LOCATION	Store	Toilet main door ,registration	Disabled Toilet Door	Autoclave, blood bank	Door towards verandah in ward	Duty room, Changing room, sluice, ward kitchen
OPENING TYPE	D5	D5A	D5B	D5C	DW	DW1
SHAPE AND SIZE						
QUANTITY	26	8	3	1	2	2
SPECIFICATION	Flush door	Flush door	Lead lined Door	Pannelled door	Pannelled door	Pannelled door
LOCATION	Inner Toilet Door	Attached toilet door	X-Ray	Janitor closet	Main entrance	Corridor



Management Division
Department of Health Service
Ministry of Health & Population



Health Building Infrastructure
Standard Design Drawings

Job Name:
 PRIMARY HOSPITAL CLASS A
 TYPE 3
 RCC Frame Structure (Brick Masonary)
 Three Storied

Scale: 1:100

Date: 2070/6/7

Drawing title:
 Opening
 Schedule

Sheet no:

AR/08

OPENING TYPE	W1	W1A	W1B	V1	V1A	W2
FLOOR LEVEL LINTEL LEVEL SHAPE AND SIZE FLOOR FINISH LEVEL STRUCTURE LEVEL						
QUANTITY	22	26	1	12	8	10
SPECIFICATION	SLIDING	SLIDING	FIXED	SLIDING	FIXED	SLIDING
LOCATION	GROUND FLOOR	FIRST FLOOR	GROUND FLOOR			FIRST FLOOR
OPENING TYPE	W2B	W2C	V2A	W3	W3B	W3C
FLOOR LEVEL LINTEL LEVEL SHAPE AND SIZE FLOOR FINISH LEVEL STRUCTURE LEVEL						
QUANTITY	1	2	8	4	1	3
SPECIFICATION	FIXED	SLIDING	FIXED	SLIDING	FIXED	SLIDING
LOCATION	GROUND FLOOR	GROUND FLOOR		GROUND FLOOR		GROUND FLOOR
OPENING TYPE	V3	V3A	W4	V4	V4A	V4B
FLOOR LEVEL LINTEL LEVEL SHAPE AND SIZE FLOOR FINISH LEVEL STRUCTURE LEVEL						
QUANTITY	9	9	1	24	8	3
SPECIFICATION	SLIDING	FIXED	FIXED LEAD LINED WINDOW	MOVABLE	FIXED	
LOCATION			GROUND FLOOR			



Management Division
Department of Health Service
Ministry of Health & Population



Health Building Infrastructure
Standard Design Drawings

Job Name:
 PRIMARY HOSPITAL CLASS A
 TYPE 3
 RCC Frame Structure (Brick Masonry)
 Three Storied

Scale: 1:100

Date: 2070/6/7

Drawing title:

Opening
Schedule

Sheet no:

AR/09

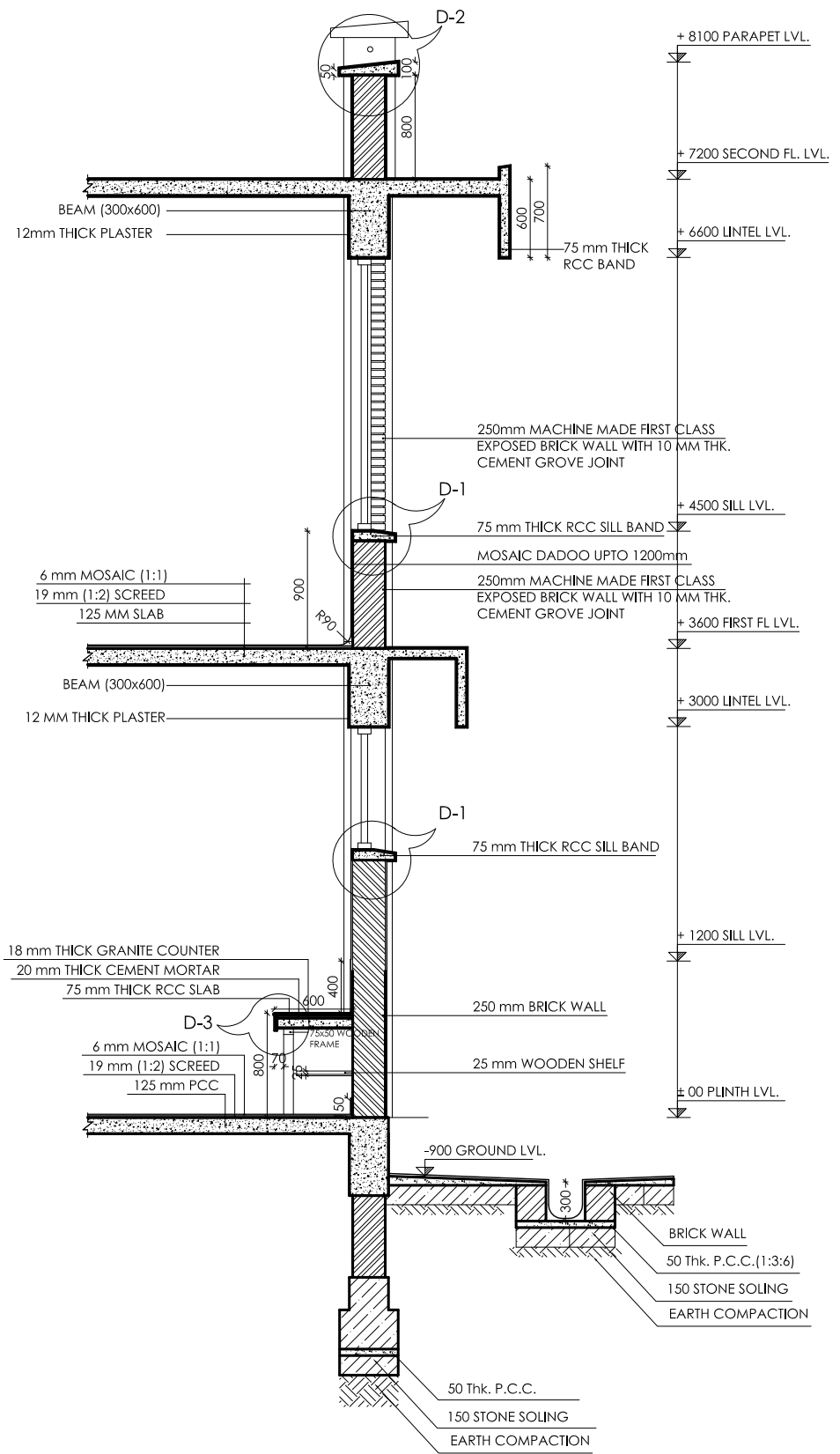

DETAIL WALL SECTION AT X

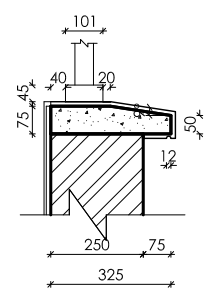

DETAIL AT D-1
SCALE = 1:20

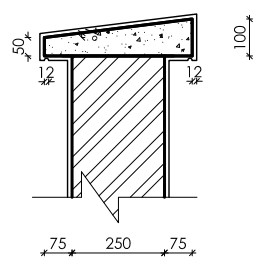

DETAIL AT D-2
SCALE = 1:20

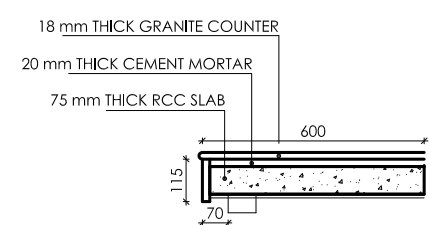

DETAIL AT D-3
SCALE = 1:20

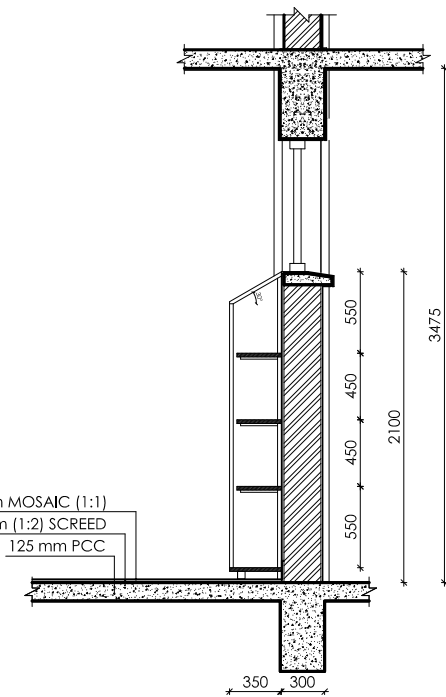

DETAIL SECTION OF CUPBOARD WITH VENTILATION ABOVE
SCALE = 1:50

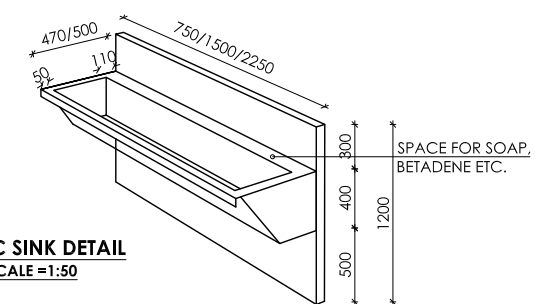

SCRUC SINK DETAIL
SCALE = 1:50



Management Division
Department of Health Service
Ministry of Health & Population



Health Building Infrastructure
Standard Design Drawings

Job Name:
PRIMARY HOSPITAL CLASS A
TYPE 3
RCC Frame Structure (Brick Masonary)
Three Storied

Scale: as specified

Date : 2070/6/7

Drawing title:
Details

Sheet no:
AR/010

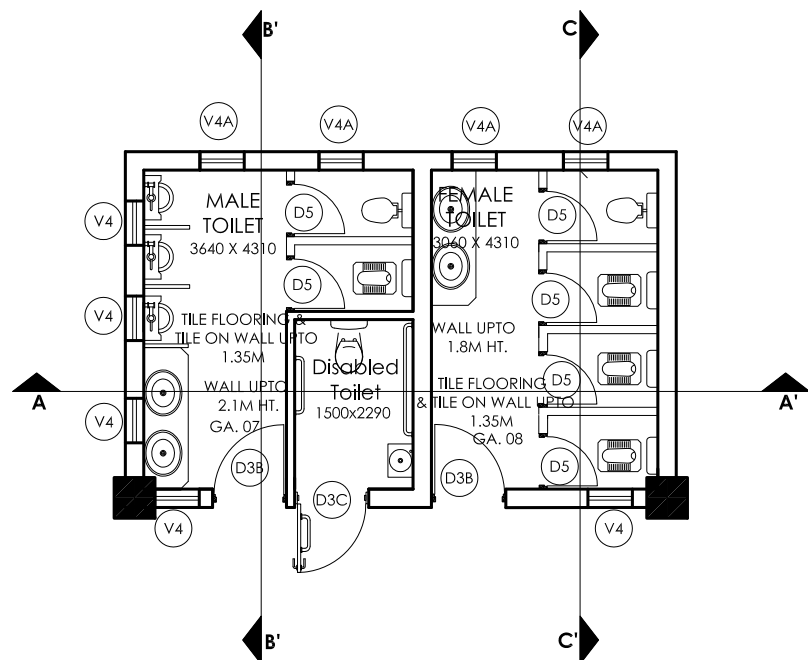

CEMENT PUNNING
 PARTITION WALL
 250 MM THICK WALL
 URINAL PARTITION
 18 mm THICK GRANITE
 100 mm THICK RCC COUNTER
 50mm, DIA. HORIZONTAL GRAB BAR AT 775MM HT FROM THE FLOOR LVL.

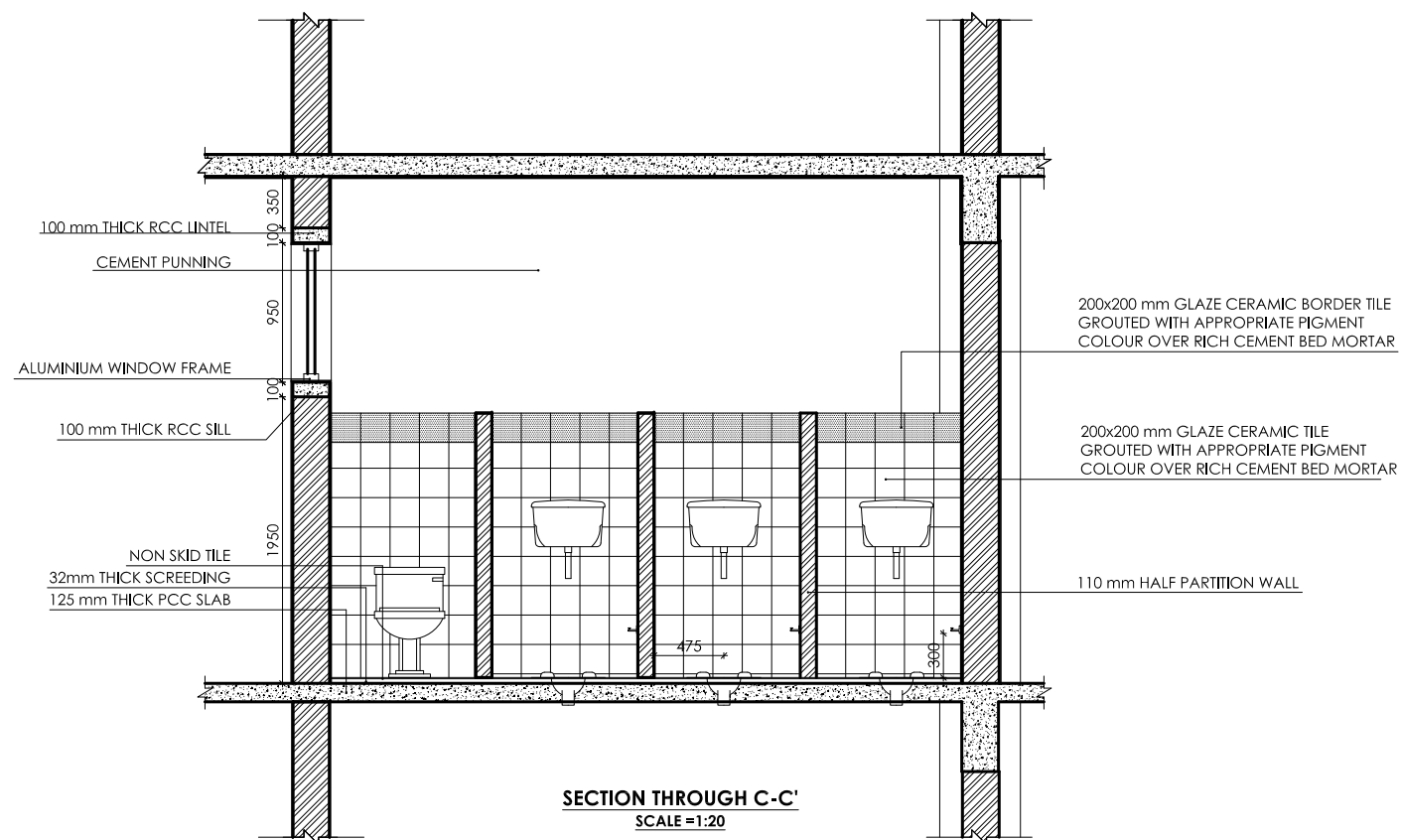
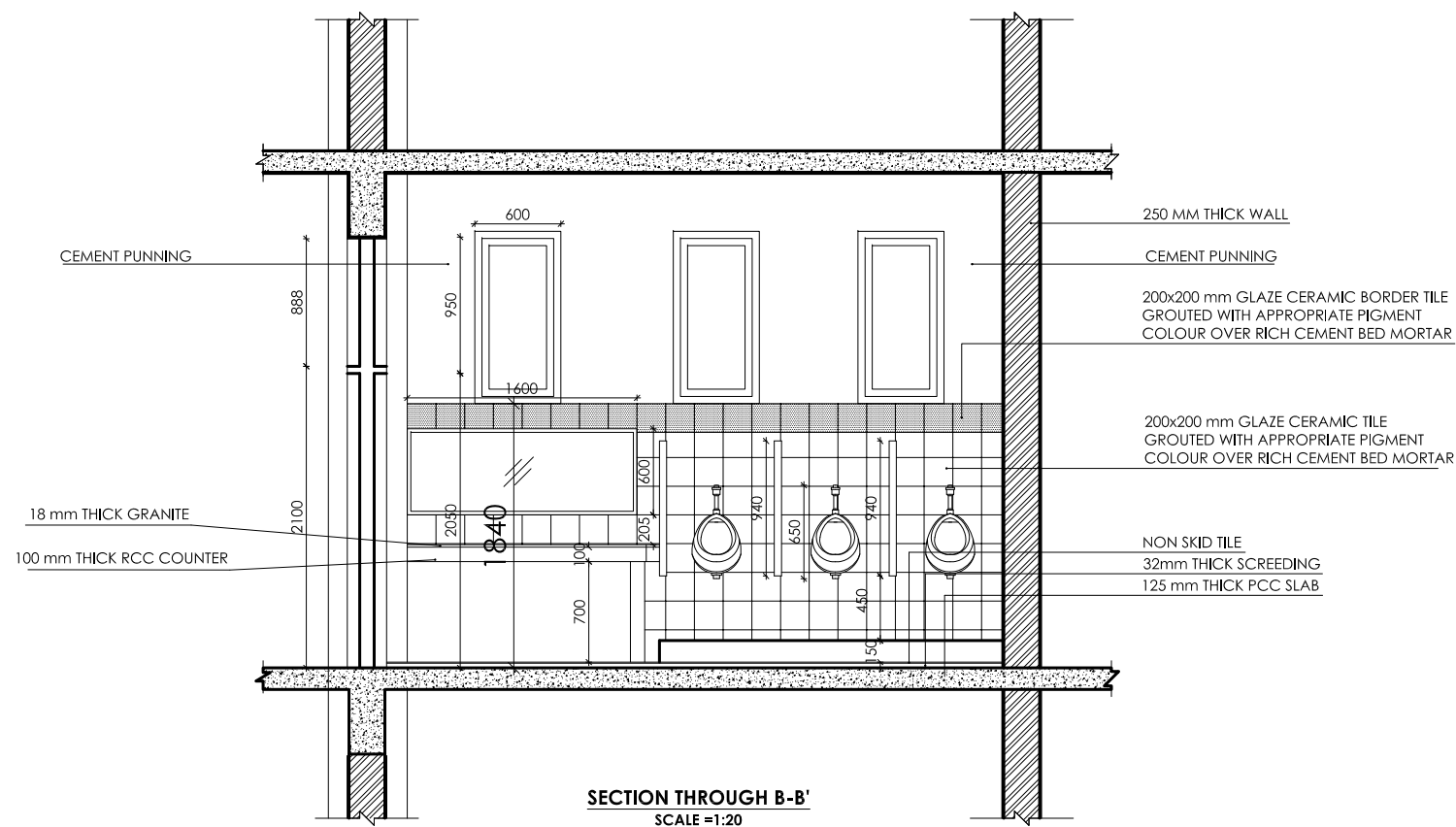
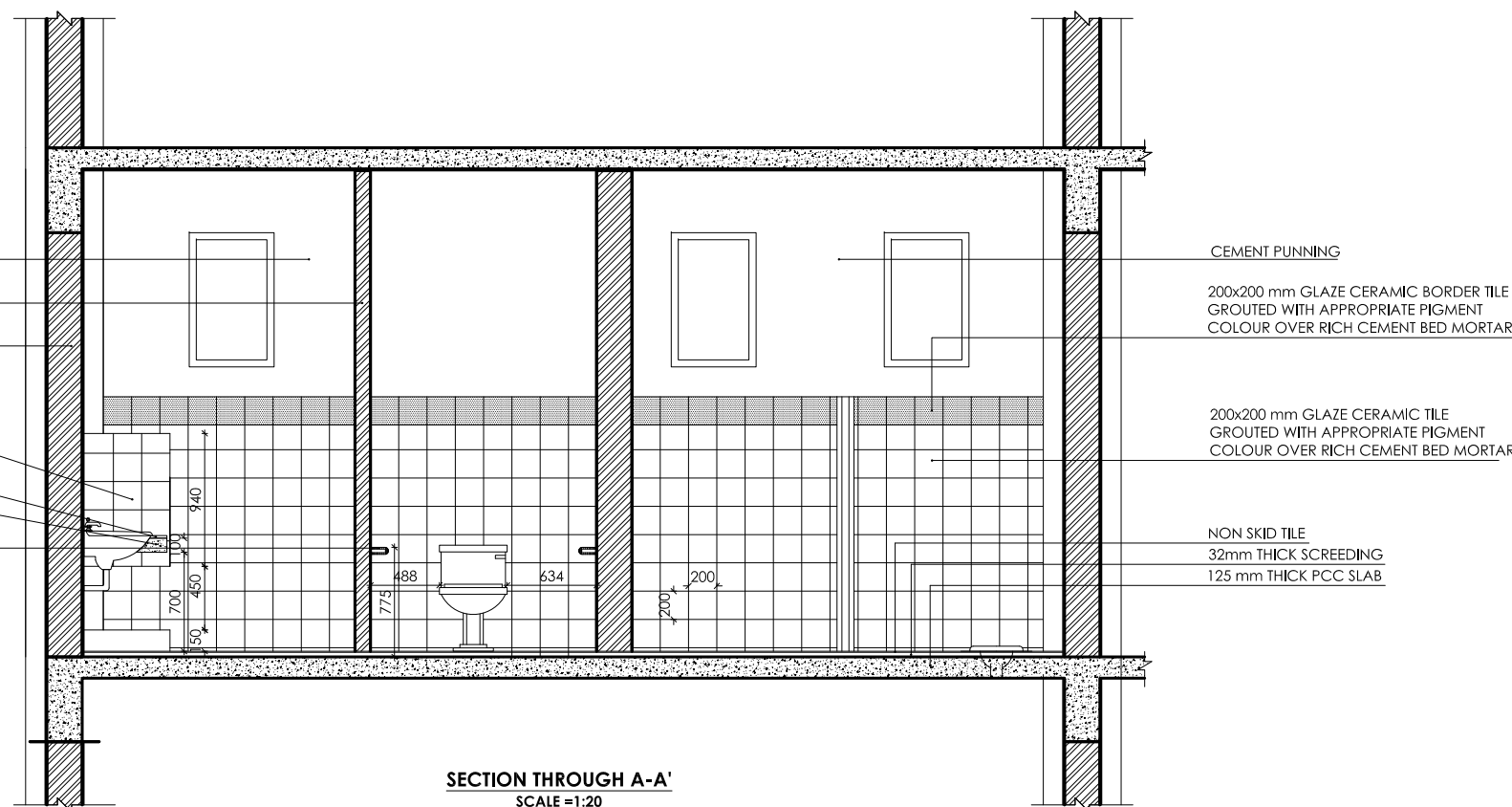

Management Division
 Department of Health Service
 Ministry of Health & Population



Health Building Infrastructure
 Standard Design Drawings

Job Name:
 PRIMARY HOSPITAL CLASS A
 TYPE 3
 RCC Frame Structure (Brick Masonry)
 Three Storied

Scale: as specified

Date : 2070/6/7

Drawing title:

Toilet Details

Sheet no:

AR/11

**PRIMARY HOSPITAL
CLASS B TYPE 1**



3D
PRIMARY HOSPITAL CLASS B TYPE 1

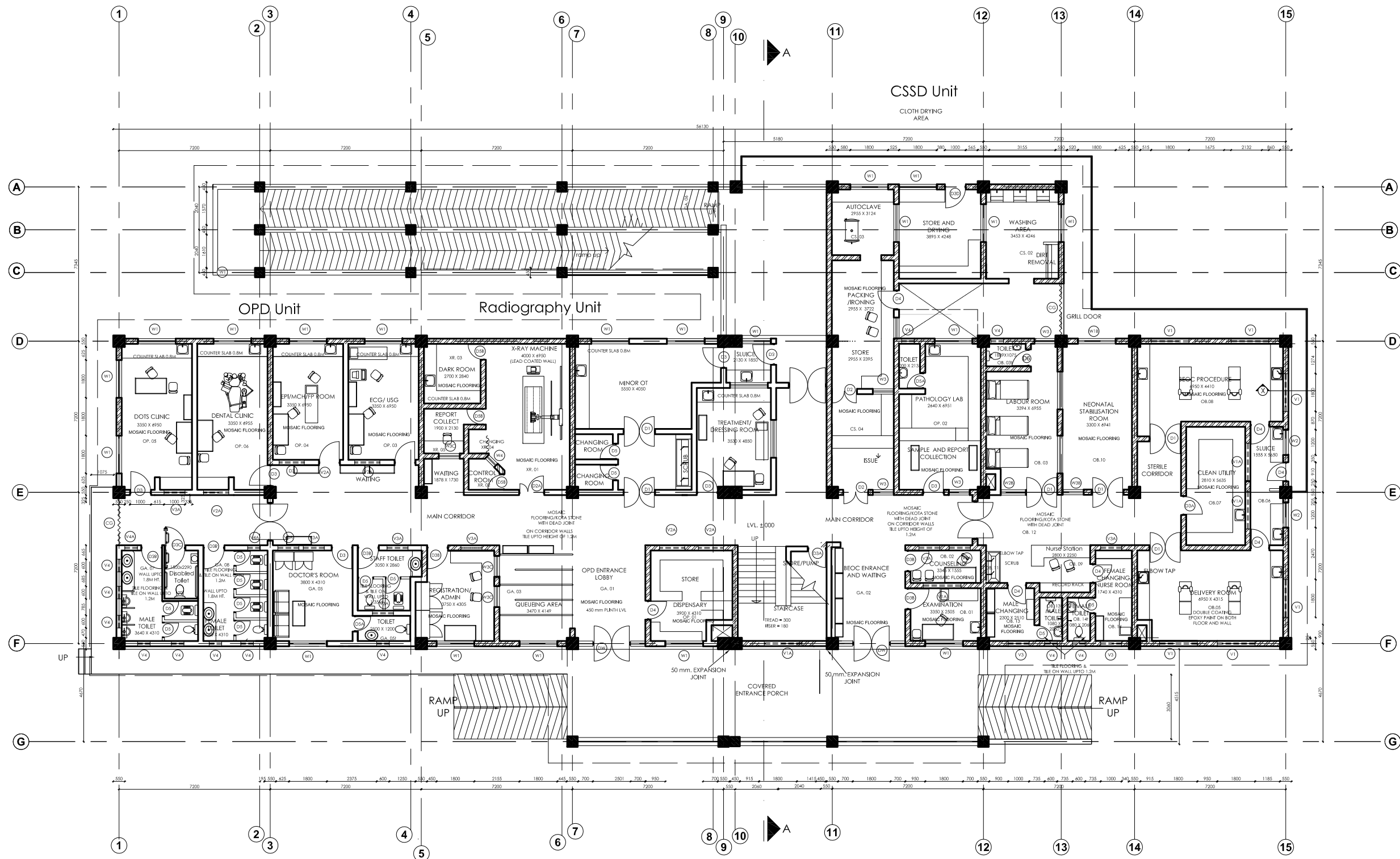

GROUND FLOOR PLAN

PLINTH AREA 1088.94 sq.m.

Note: Expandable up to 25 Beds

	<p>Management Division Department of Health Service Ministry of Health</p>		<p>Health Building Infrastructure Standard Design Drawings</p>	<p>Job Name: PRIMARY HOSPITAL CLASS A TYPE 3 RCC Frame Structure (Brick Masonary) Three Storied</p> <p>Scale: 1:100</p> <p>Date : 2070/.../....</p>	<p>Drawing title: Ground Floor Plan (with Furniture Layout</p> <p>Page no: 00</p>	<p>Sheet no: AR/01</p>
--	---	--	---	--	---	---

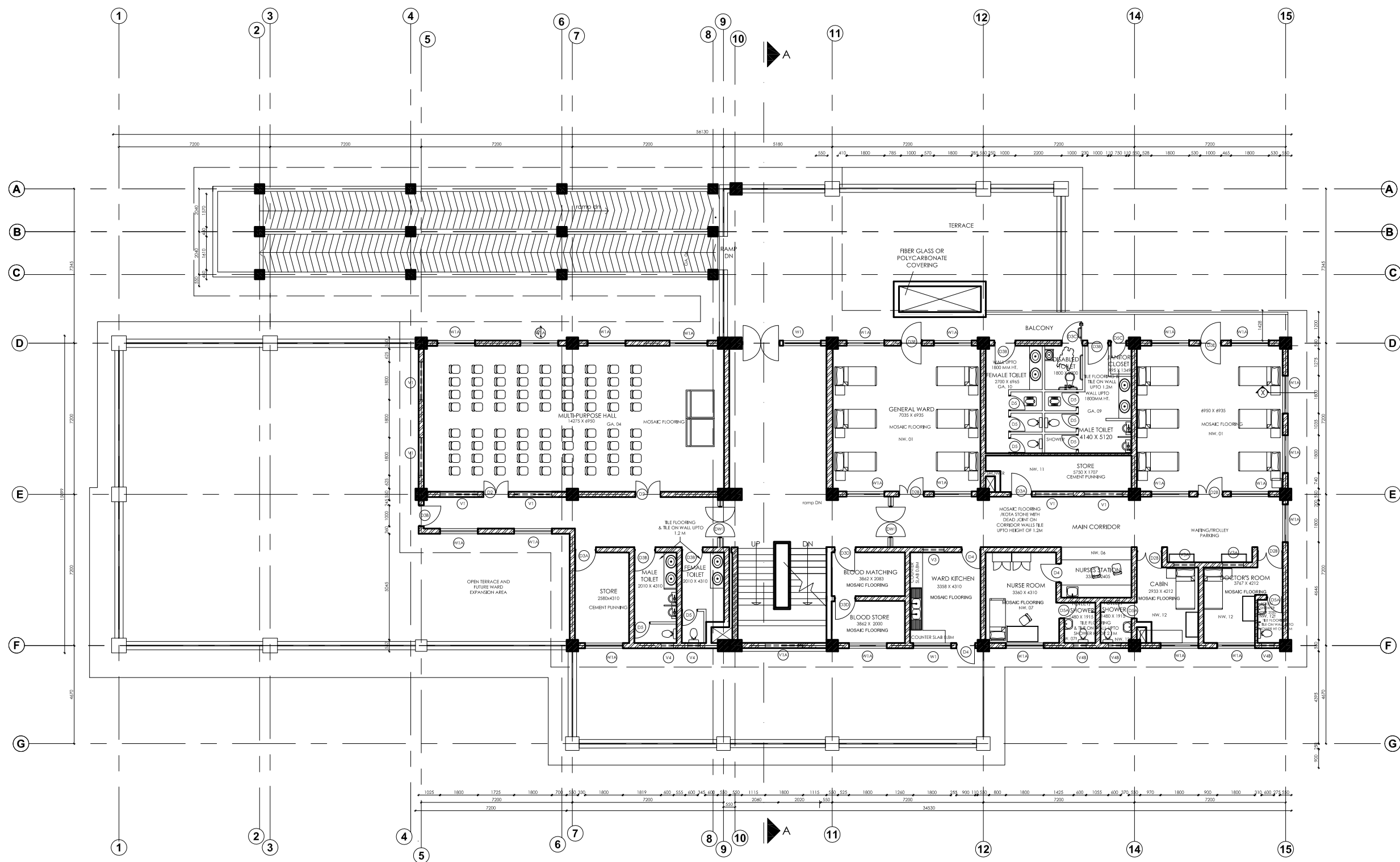

FIRST FLOOR PLAN
 FLOOR AREA-657. 79 sq.m.

Note: Expandable up to 25 Beds

Management Division
 Department of Health Service
 Ministry of Health



Health Building Infrastructure
 Standard Design Drawings

Job Name:
 PRIMARY HOSPITAL CLASS A
 TYPE 3
 RCC Frame Structure (Brick Masonary)
 Three Storied

Scale: 1:100

Date : 2070/.../....

Drawing title:
 First Floor Plan
 with Furniture
 Layout

Page no: 00

Sheet no:

AR/02



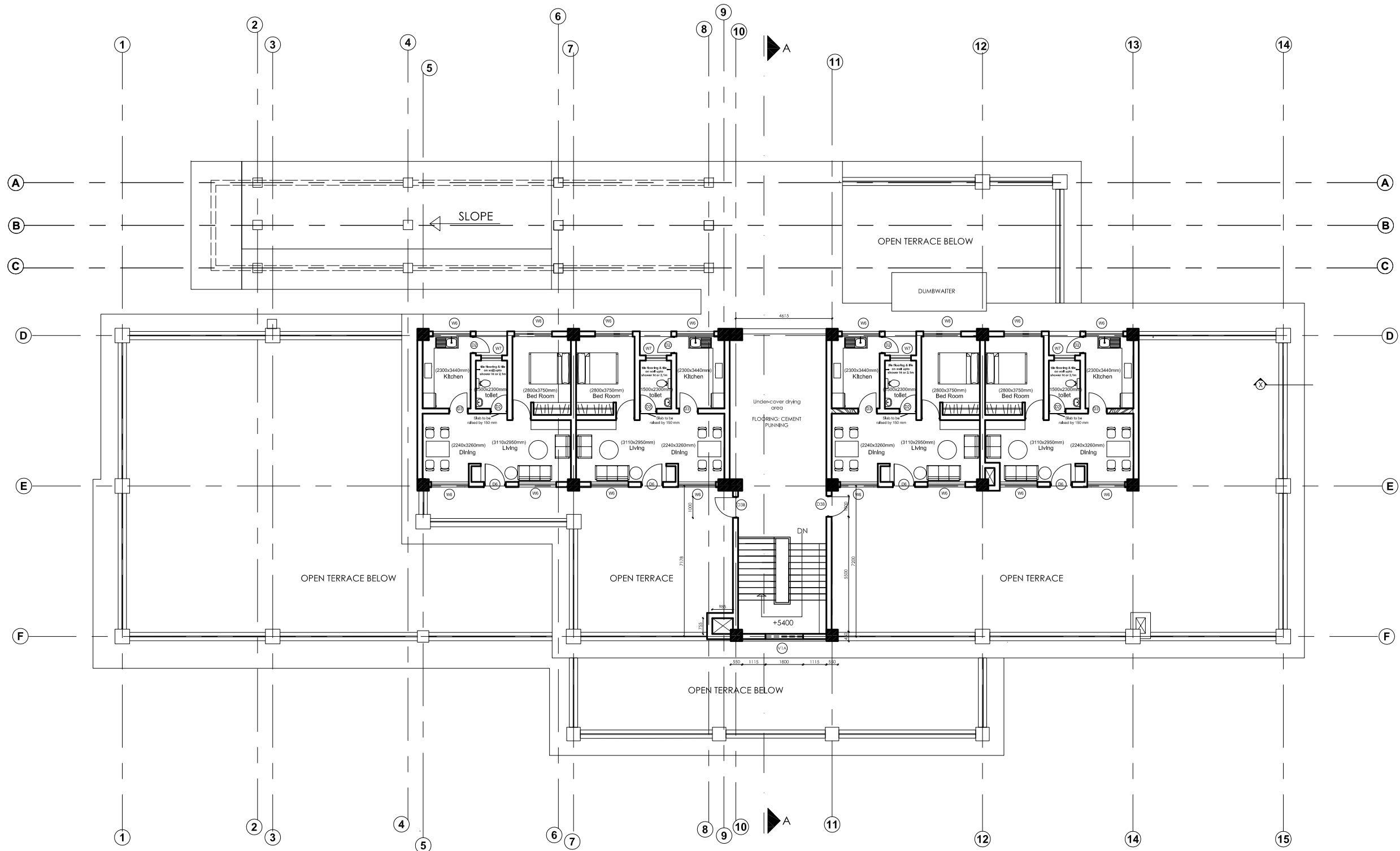

SECOND FLOOR PLAN
 FLOOR AREA-300 SQ.M.

Note: Expandable up to 25 Beds

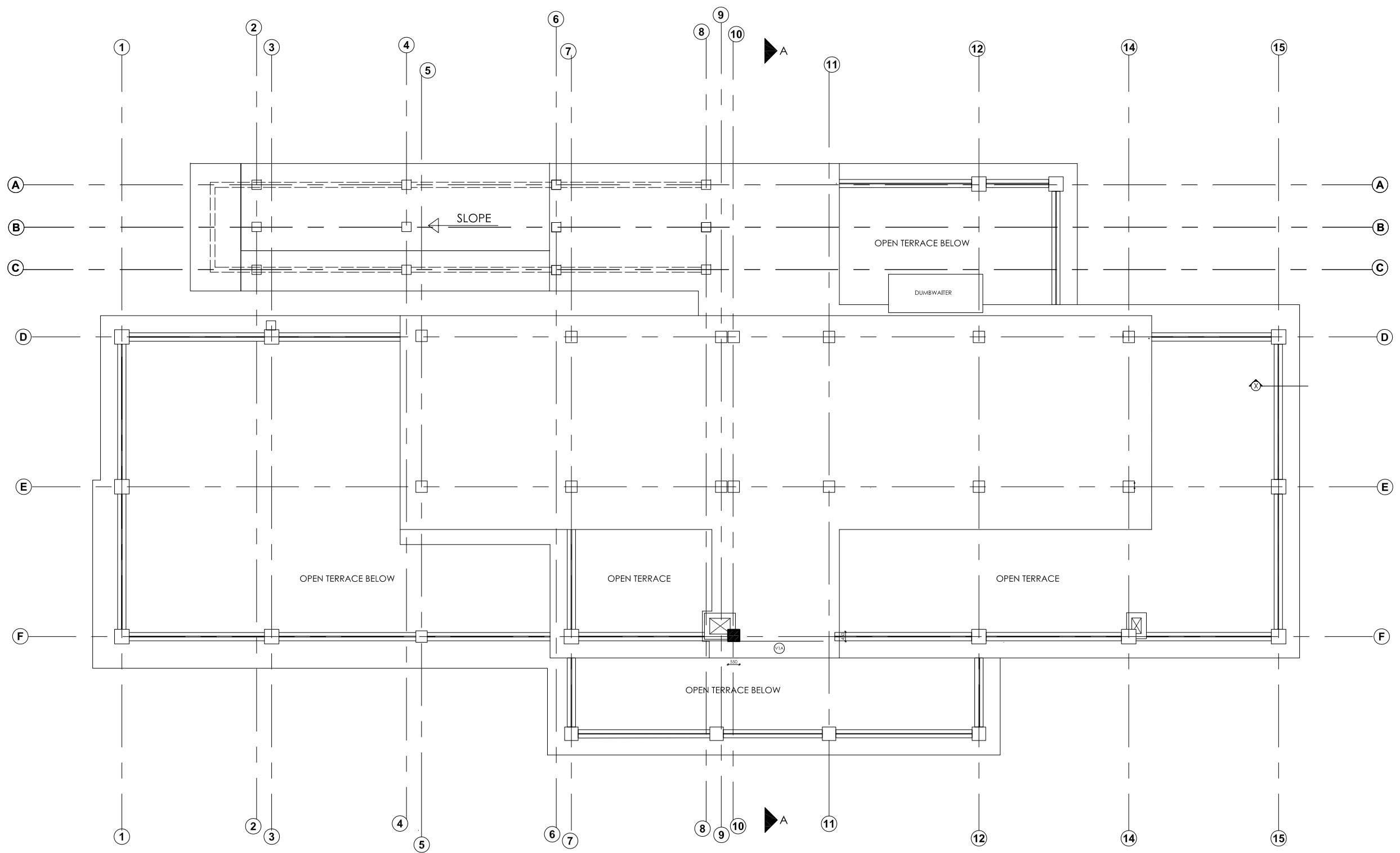

ROOF PLAN

Note: Expandable up to 25 Beds



**Management Division
Department of Health Service
Ministry of Health**



**Health Building Infrastructure
Standard Design Drawings**

Job Name:
PRIMARY HOSPITAL CLASS A
TYPE 3
RCC Frame Structure (Brick Masonary)
Three Storied

Scale: 1:100

Date : 2070/.../....

Drawing title:

**Ground Floor
Plan (with
Furniture Layout**

Page no: 00

Sheet no:

AR/04

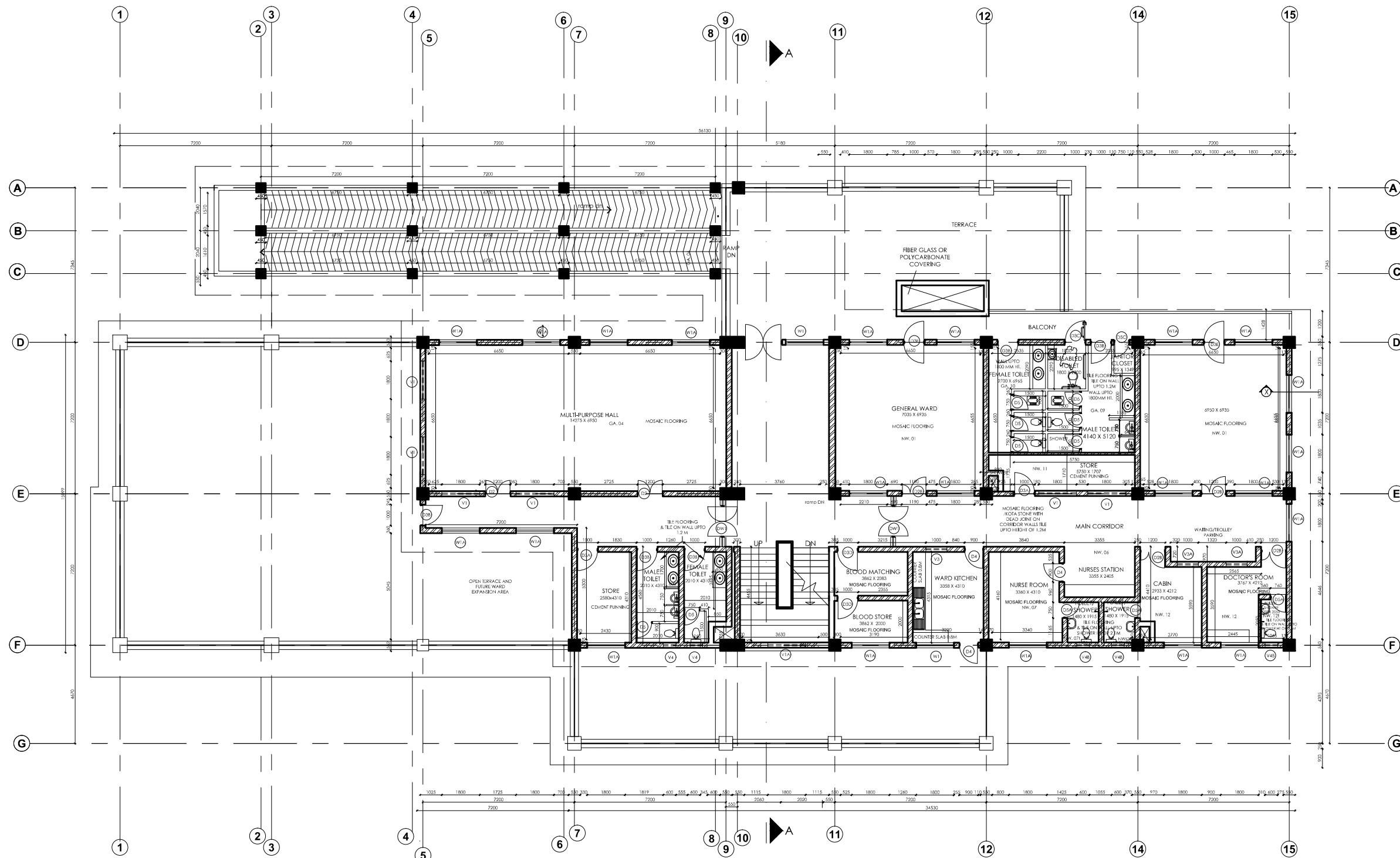

FIRST FLOOR PLAN
 FLOOR AREA-657.79 sq.m.

Note: Expandable up to 25 Beds



Management Division
Department of Health Service
Ministry of Health



Health Building Infrastructure
Standard Design Drawings

Job Name:
 PRIMARY HOSPITAL CLASS B
 TYPE 1
 RCC Frame Structure
 Three Storied
Scale: 1:100
Date : 2070/.../....

Drawing title:
 First Floor Plan
 with internal
 dimension

Sheet no:

AR/05



FRONT ELEVATION

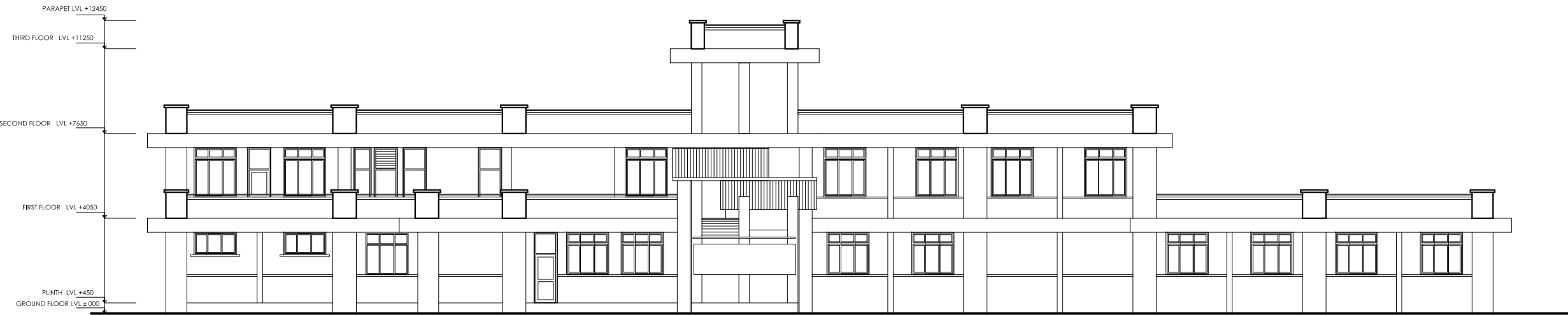

BACK ELEVATION



Management Division
Department of Health Service
Ministry of Health



Health Building Infrastructure
Standard Design Drawings

Job Name:
PRIMARY HOSPITAL CLASS A
TYPE 3
RCC Frame Structure (Brick Masonary)
Three Storied
Scale: 1:100
Date : 2070/.../....

Drawing title:
Elevations
Page no: 00

Sheet no:
AR/06

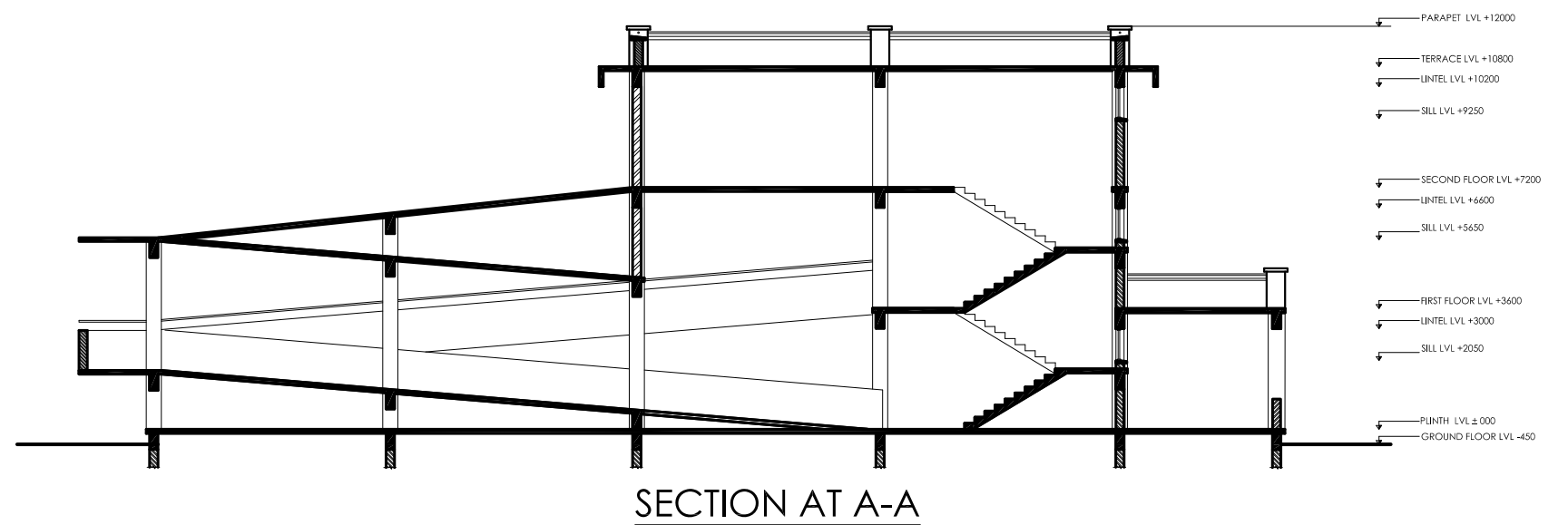

Management Division
Department of Health Service
Ministry of Health



Health Building Infrastructure
Standard Design Drawings

Job Name:
PRIMARY HOSPITAL CLASS A
TYPE 3
RCC Frame Structure (Brick Masonary)
Three Storied

Scale: 1:100

Date : 2070/.../....

Drawing title:

Elevation and
Section

Page no: 00

Sheet no:

AR/07

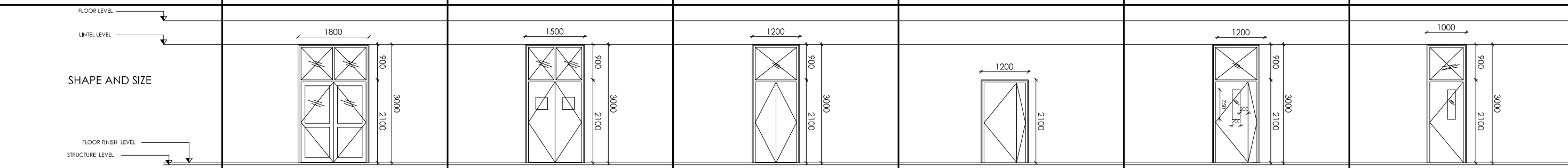
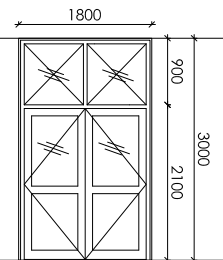
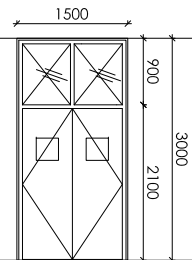
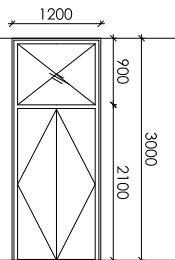
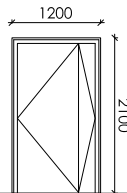
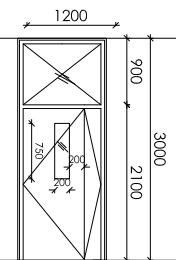
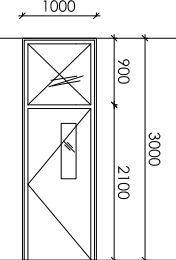
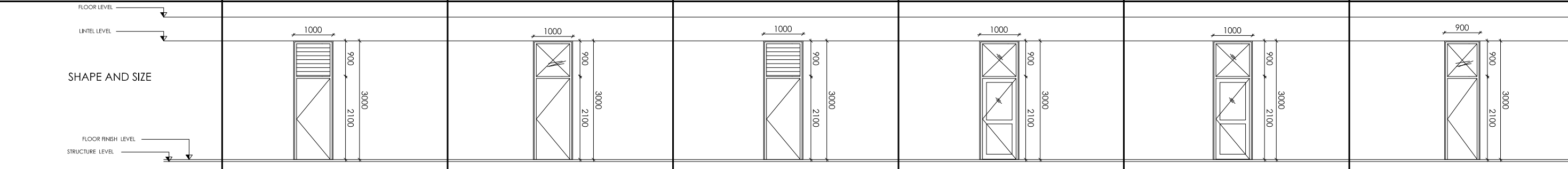
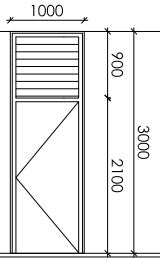
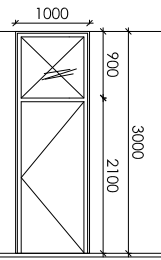
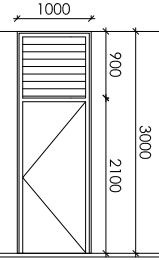
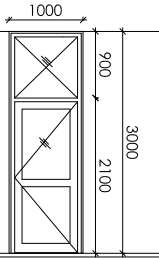
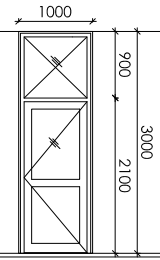
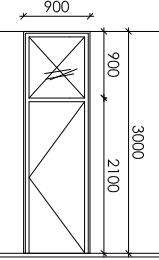
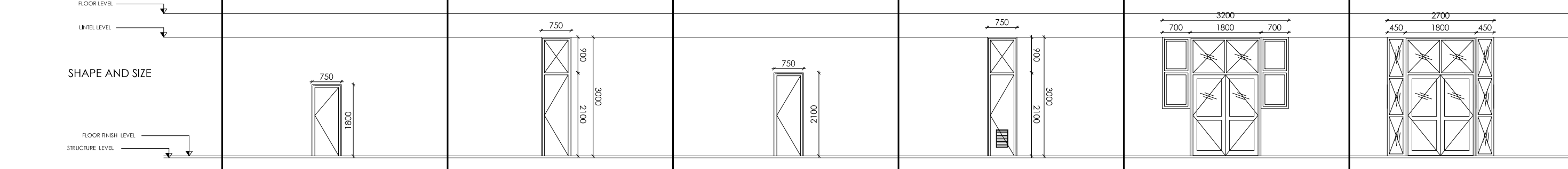
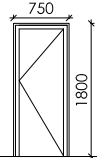
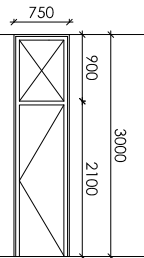
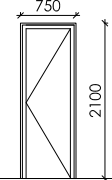
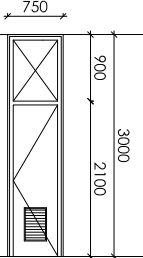
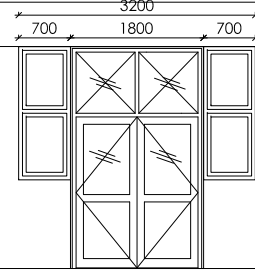
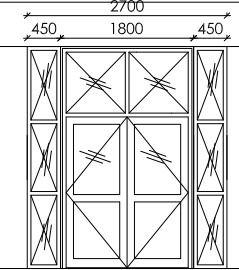

OPENING TYPE	D	D1	D2	D2A	D2B	D3
SHAPE AND SIZE 						
QUANTITY	1	4	4	1	4	8
SPECIFICATION	upper half- transparent glass, lower half panel; both way swing	flush door with viewing pane ; both way swing	Flush Door	Lead lined Door	flush door with viewing pane	flush door with viewing pane
LOCATION	Corridor	Delivery, Labour Room, Procedure	Multipurpose Hall, sterilised items out	X-Ray	Wards	OPD
OPENING TYPE	D3A	D3B	D3C	D3D	D3E	D4
SHAPE AND SIZE 						
QUANTITY	5	13	2	3	2	9
SPECIFICATION	Flush door	Flush door	Double Swing flush door	Upper half Glass, lower half paneled door	Double Swing Paneled door	flush door
LOCATION	Store	Toilet main door ,registration	Disabled Toilet Door	Autoclave, blood bank	Door towards verandah in ward	Duty room, Changing room, sluice, ward kitchen
OPENING TYPE	D5	D5A	D5B	D5C	DW	DW1
SHAPE AND SIZE 						
QUANTITY	20	5	3	1	2	2
SPECIFICATION	Flush door	Flush door	Lead lined Door	Pannelled door	Pannelled door	Pannelled door
LOCATION	Inner Toilet Door	Attached toilet door	X-Ray	Janitor closet	Main entrance	Corridor



**Management Division
Department of Health Service
Ministry of Health**



**Health Building Infrastructure
Standard Design Drawings**

Job Name:
PRIMARY HOSPITAL CLASS A
TYPE 3
RCC Frame Structure (Brick Masonary)
Three Storied

Scale: 1:100

Date : 2070/.../....

Drawing title:

**Opening
Schedule**

Page no: 00

Sheet no:

AR/08

OPENING TYPE	W1	W1A	W1B	V1	V1A	W2
SHAPE AND SIZE						
QUANTITY	20	26	1	12	6	2
SPECIFICATION	SLIDING	SLIDING	FIXED	SLIDING	FIXED	SLIDING
LOCATION	GROUND FLOOR	FIRST FLOOR	GROUND FLOOR			FIRST FLOOR
OPENING TYPE	W2B	W2C	V2A	W3	W3B	W3C
SHAPE AND SIZE						
QUANTITY	1	2	7	4	1	3
SPECIFICATION	FIXED	SLIDING	FIXED	SLIDING	FIXED	SLIDING
LOCATION	GROUND FLOOR	GROUND FLOOR		GROUND FLOOR		GROUND FLOOR
OPENING TYPE	V3	V3A	W4	V4	V4A	V4B
SHAPE AND SIZE						
QUANTITY	3	11	1	13	4	3
SPECIFICATION	SLIDING	FIXED	FIXED LEAD LINED WINDOW	MOVABLE	FIXED	
LOCATION			GROUND FLOOR			

Drawing title:



Management Division
Department of Health Service
Ministry of Health



Health Building Infrastructure
Standard Design Drawings

Job Name:
PRIMARY HOSPITAL CLASS A
TYPE 3
RCC Frame Structure (Brick Masonry)
Three Storied
Scale: 1:100
Date : 2070/.../....

Drawing title:
Opening
Schedule
Page no: 00

Sheet no:
AR/09

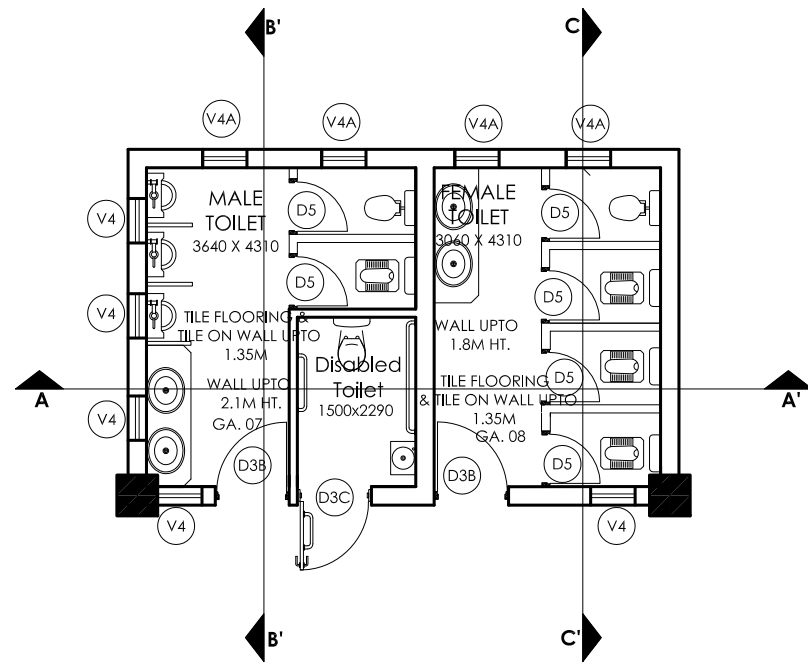

CEMENT PUNNING
 PARTITION WALL
 250 MM THICK WALL
 URINAL PARTITION
 18 mm THICK GRANITE
 100 mm THICK RCC COUNTER
 50mm. DIA. HORIZONTAL GRAB BAR AT 775MM HT FROM THE FLOOR LVL.

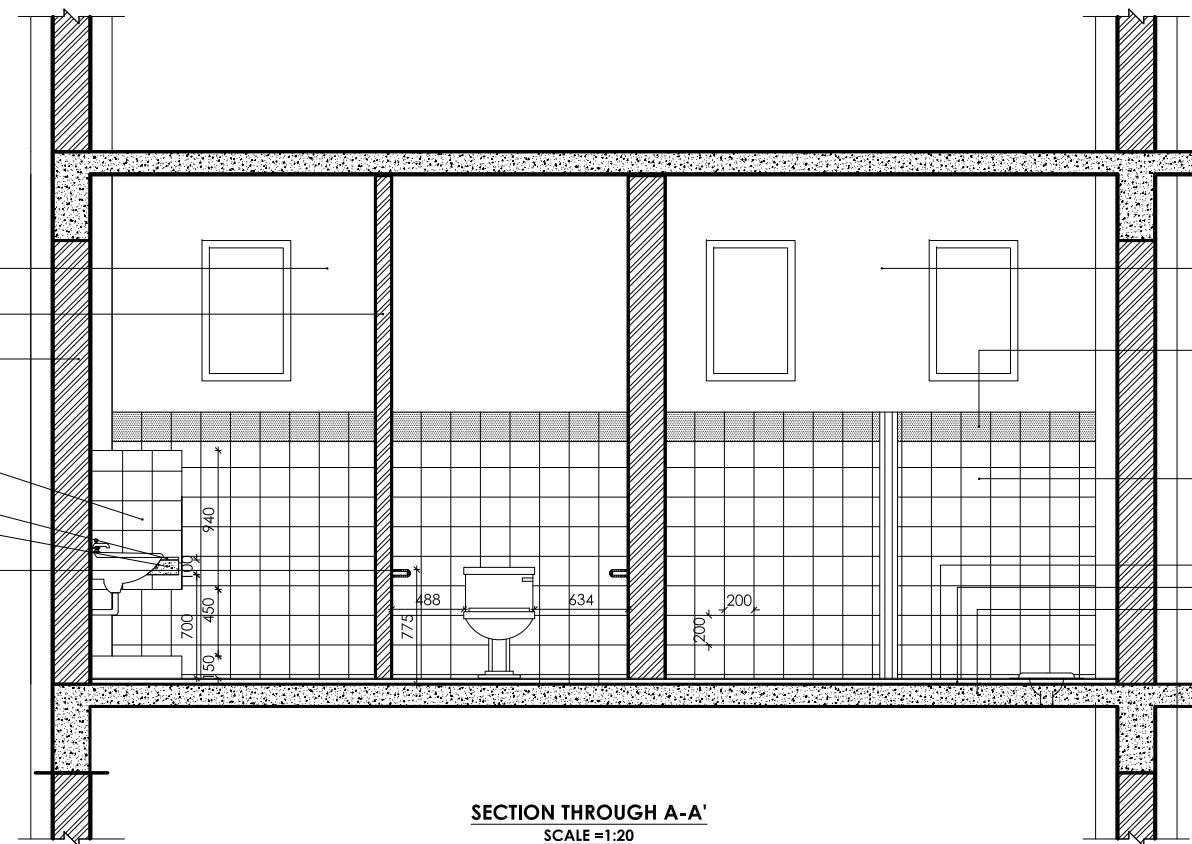

CEMENT PUNNING
 200x200 mm GLAZE CERAMIC BORDER TILE GROUTED WITH APPROPRIATE PIGMENT COLOUR OVER RICH CEMENT BED MORTAR
 200x200 mm GLAZE CERAMIC TILE GROUTED WITH APPROPRIATE PIGMENT COLOUR OVER RICH CEMENT BED MORTAR
 NON SKID TILE
 32mm THICK SCREEDING
 125 mm THICK PCC SLAB

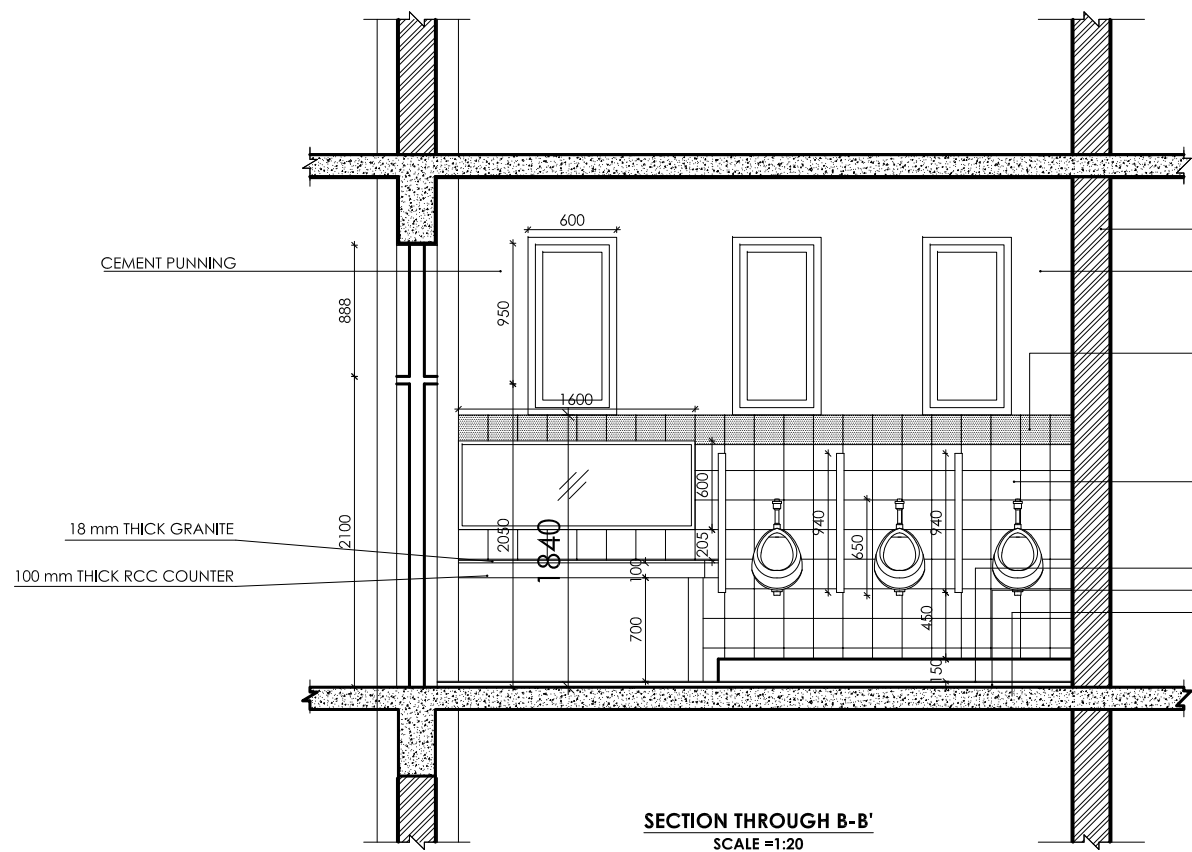

250 MM THICK WALL
 CEMENT PUNNING
 200x200 mm GLAZE CERAMIC BORDER TILE GROUTED WITH APPROPRIATE PIGMENT COLOUR OVER RICH CEMENT BED MORTAR
 200x200 mm GLAZE CERAMIC TILE GROUTED WITH APPROPRIATE PIGMENT COLOUR OVER RICH CEMENT BED MORTAR
 18 mm THICK GRANITE
 100 mm THICK RCC COUNTER
 NON SKID TILE
 32mm THICK SCREEDING
 125 mm THICK PCC SLAB

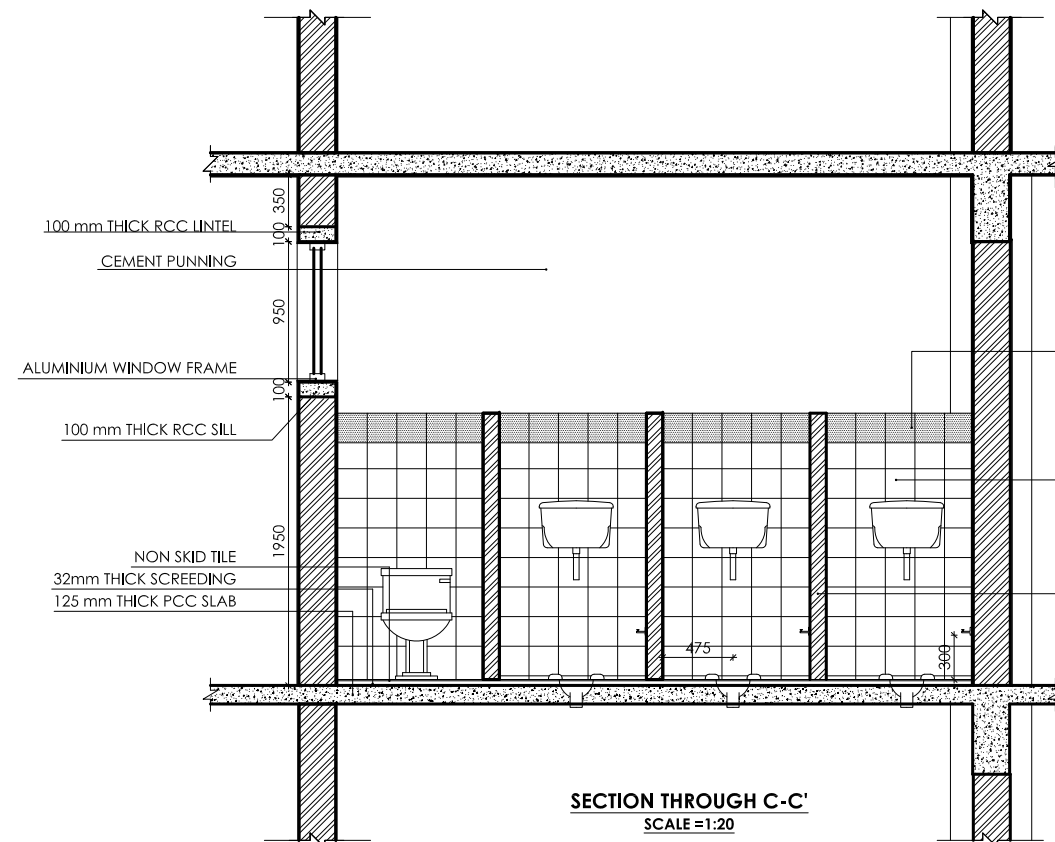

100 mm THICK RCC LINTEL
 CEMENT PUNNING
 ALUMINIUM WINDOW FRAME
 100 mm THICK RCC SILL
 200x200 mm GLAZE CERAMIC BORDER TILE GROUTED WITH APPROPRIATE PIGMENT COLOUR OVER RICH CEMENT BED MORTAR
 200x200 mm GLAZE CERAMIC TILE GROUTED WITH APPROPRIATE PIGMENT COLOUR OVER RICH CEMENT BED MORTAR
 NON SKID TILE
 32mm THICK SCREEDING
 125 mm THICK PCC SLAB
 110 mm HALF PARTITION WALL

**PRIMARY HOSPITAL
CLASS B TYPE 2**

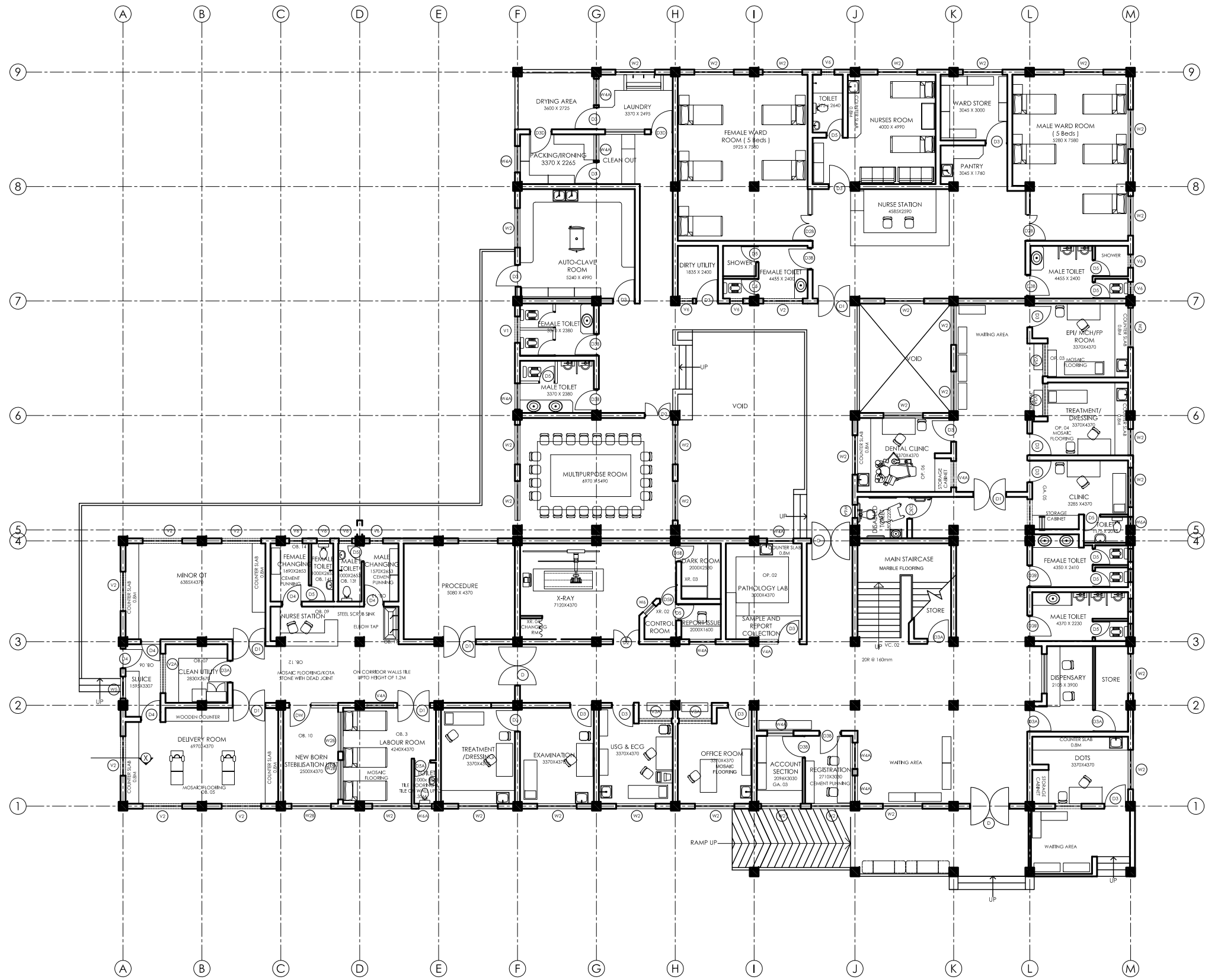

GROUND FLOOR PLAN
FLOOR AREA-1096.38 sq.m.



Management Division
Department of Health Service
Ministry of Health



Health Building Infrastructure
Standard Design Drawings

Job Name:
PRIMARY HOSPITAL CLASS "B"
TYPE 2
RCC frame structure (Brick Masonary)
One storied

Scale: 1:200

Date : 2073/9/14

Drawing title:
Ground Floor Plan

Sheet no:
AR/01

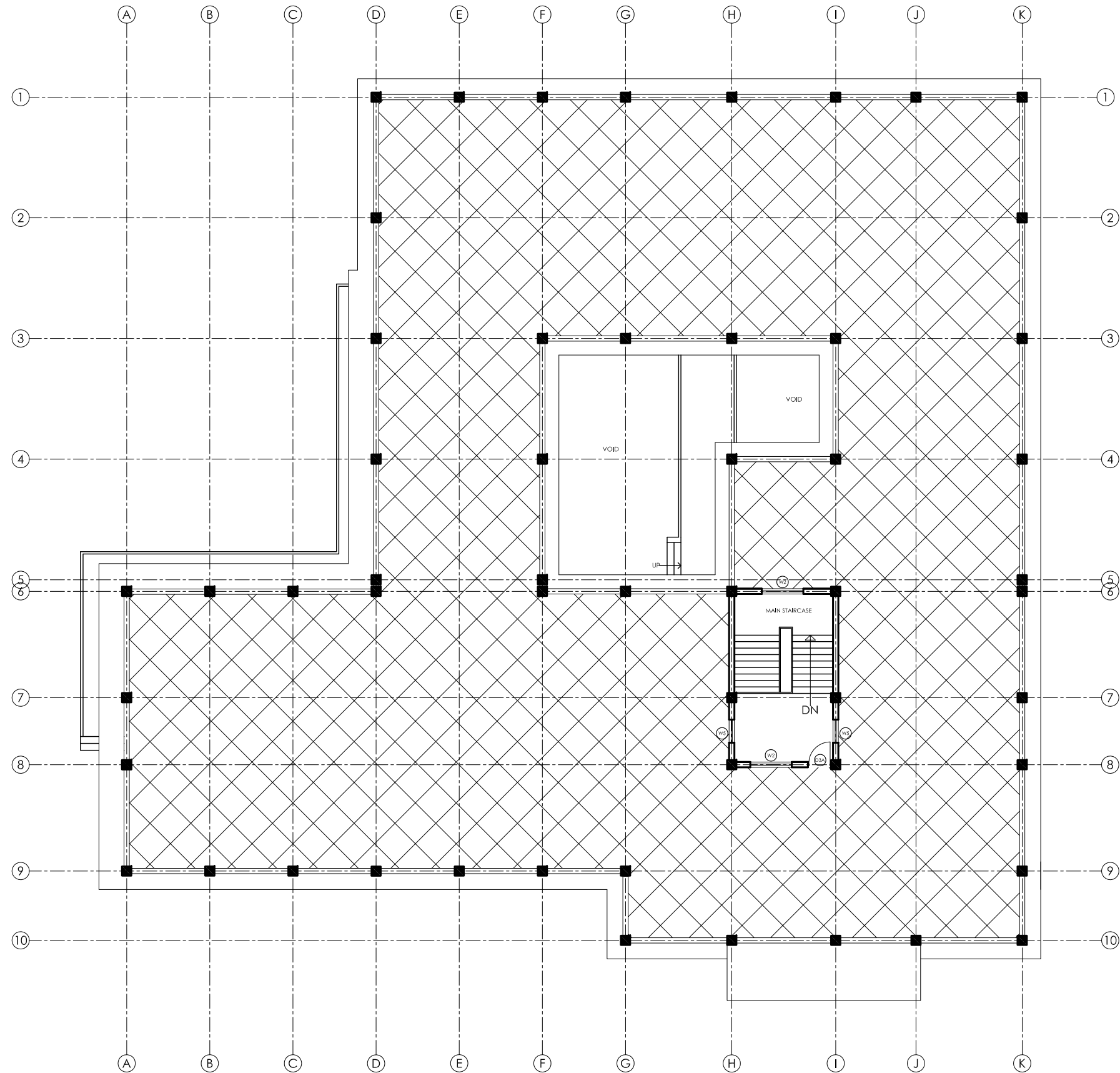

ROOF FLOOR PLAN

**Management Division
Department of Health Service
Ministry of Health**



**Health Building Infrastructure
Standard Design Drawings**

Job Name:
PRIMARY HOSPITAL CLASS "B"
TYPE 2
RCC frame structure (Brick Masonry)
One storied

Scale: 1:200

Date : 2073/9/14

Drawing title:

Roof Plan

Sheet no:

AR/02





REAR ELEVATION



FRONT ELEVATION



Management Division
Department of Health Service
Ministry of Health



Health Building Infrastructure
Standard Design Drawings

Job Name:
PRIMARY HOSPITAL CLASS "B"
TYPE 2
RCC frame structure (Brick Masonry)
One storied

Scale: 1:100

Date : 2073/9/14

Drawing title:

ELEVATIONS

Sheet no:

AR/03

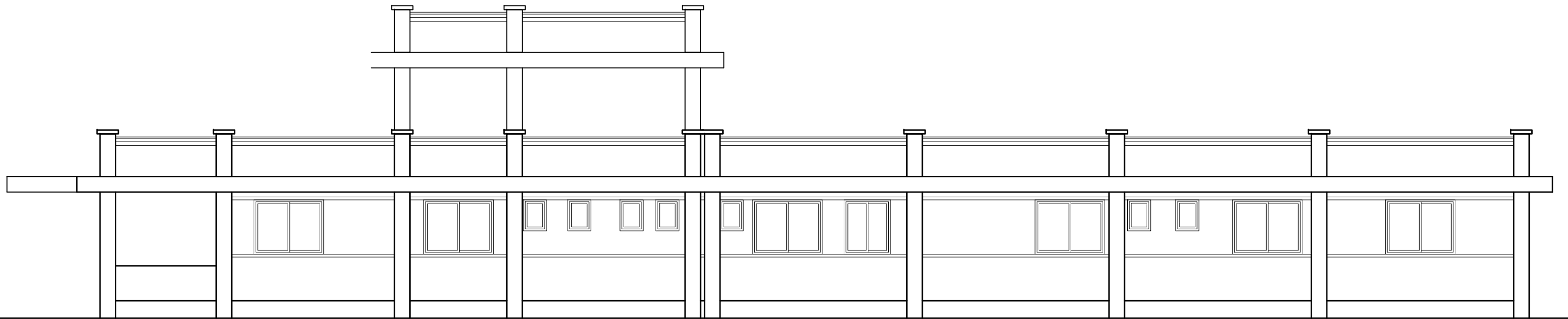

SIDE ELEVATION

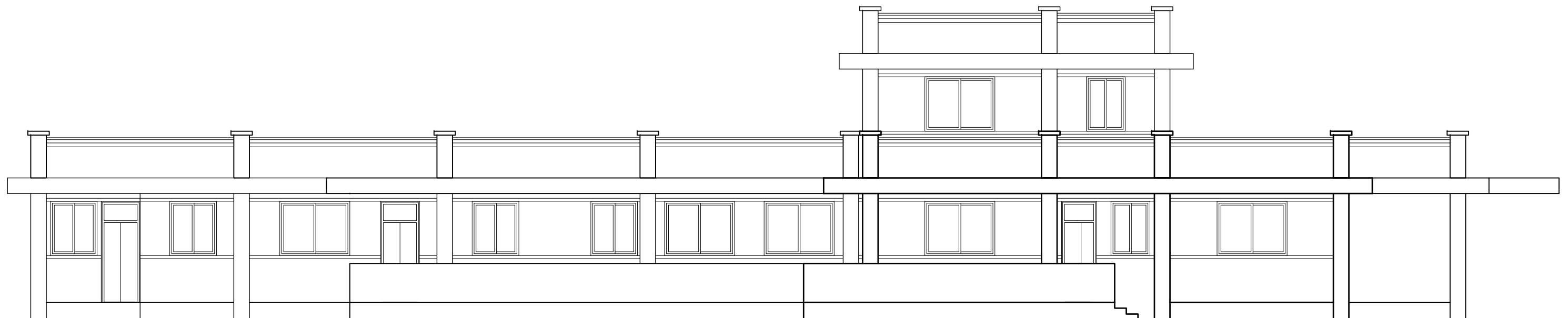

SIDE ELEVATION



Management Division
Department of Health Service
Ministry of Health



Health Building Infrastructure
Standard Design Drawings

Job Name:
PRIMARY HOSPITAL CLASS "B"
TYPE 2
RCC frame structure (Brick Masonary)
One storied

Scale: 1:100

Date : 2073/9/14

Drawing title:

ELEVATIONS

Sheet no:

AR/04

**PRIMARY HOSPITAL
CLASS B TYPE 3**

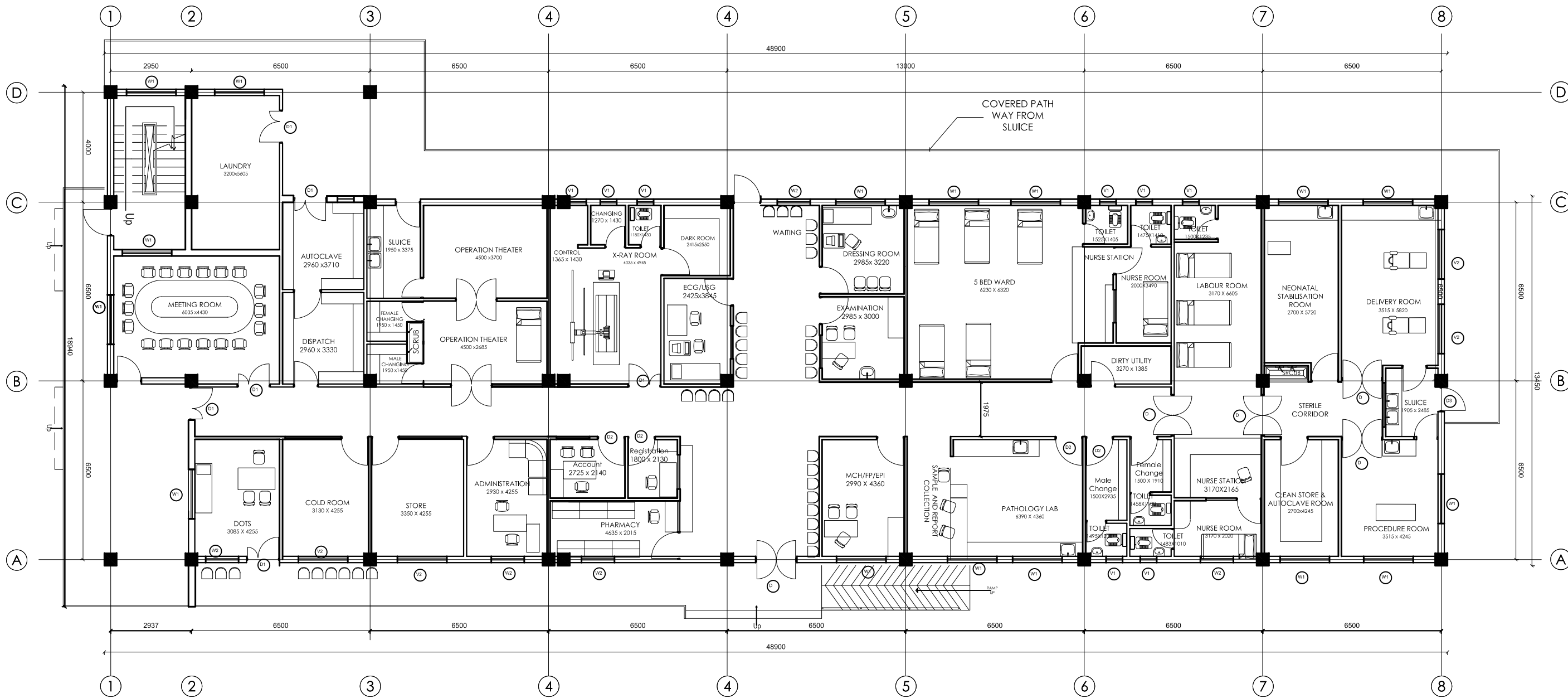

GROUND FLOOR PLAN
AREA: 697.30 SQ. M.



Management Division
Department of Health Service
Ministry of Health



Health Building Infrastructure
Standard Design Drawings

Job Name:
Primary Hospital Class B
Type 3
RCC frame structure (Brick Masonry)
Two storied

Scale: 1:150

Date: 2073/11/..

Drawing title:
GROUND FLOOR
PLAN

Sheet no:
AR/01

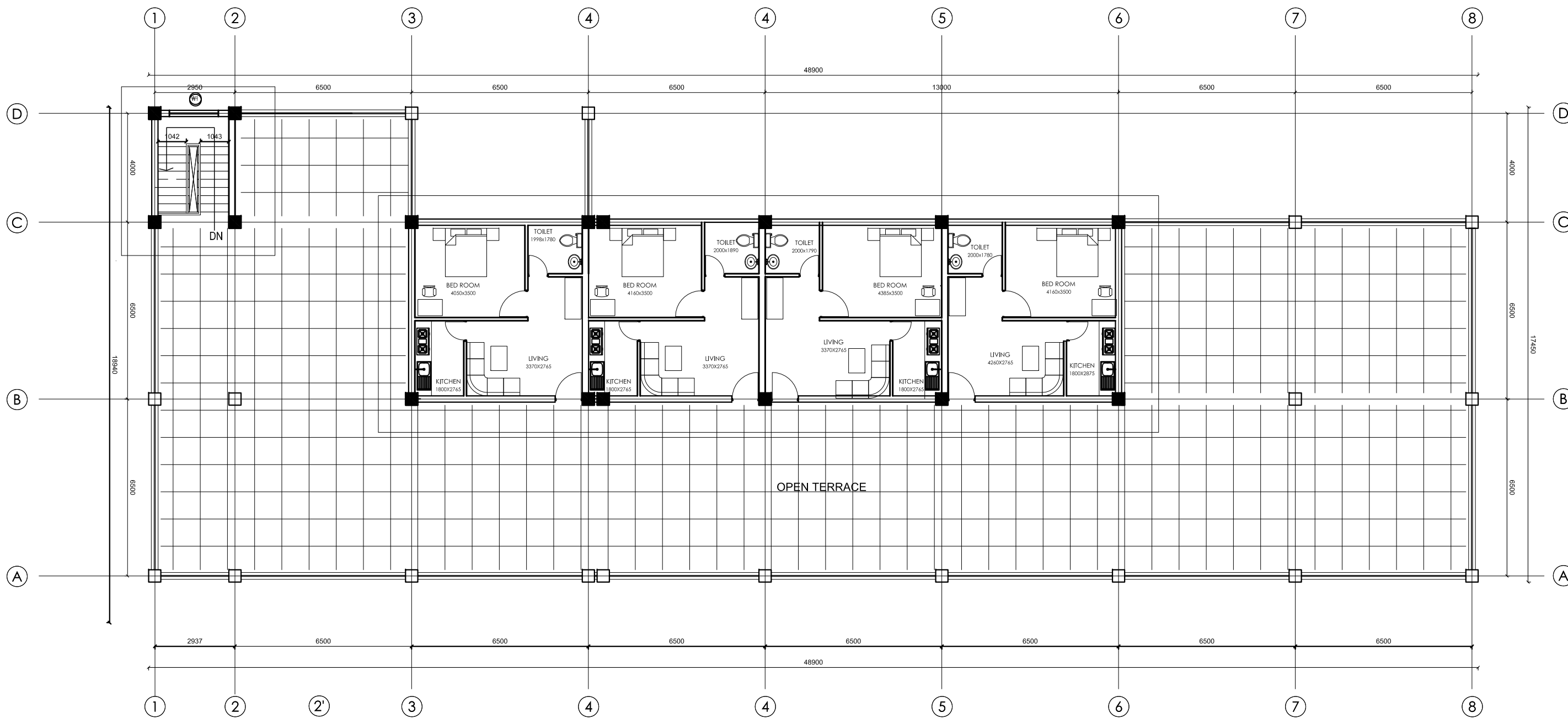

TOP FLOOR PLAN
 AREA: 198.95 SQ. M.

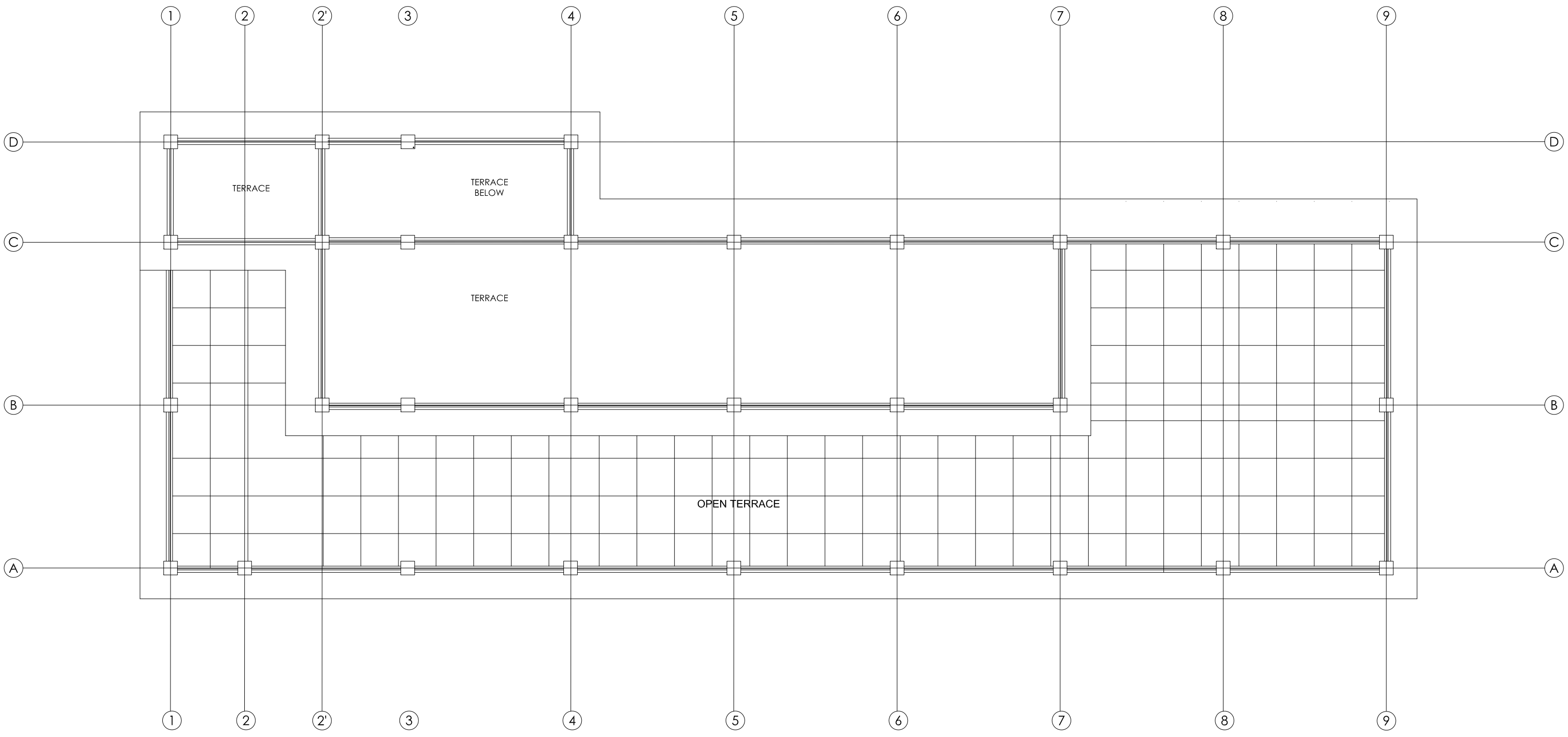

FIRST FLOOR PLAN
 AREA: 72.07 SQ. M



Management Division
 Department of Health Service
 Ministry of Health



Health Building Infrastructure
 Standard Design Drawings

Job Name:
 Primary Hospital Class B
 Type 3
 RCC frame structure (Brick Masonary)
 Two storied
 Scale: 1:150
 Date : 2073/11/..

Drawing title:
 ROOF PLAN

Sheet no:
 AR/03



SOUTH ELEVATION

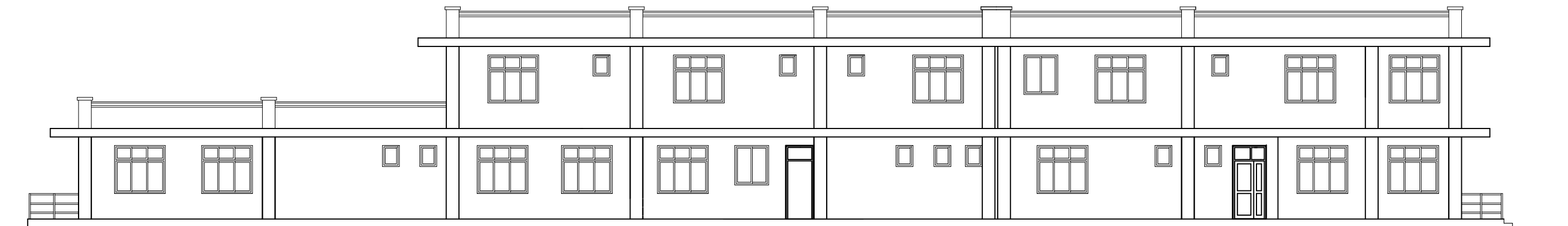

NORTH ELEVATION



Management Division
Department of Health Service
Ministry of Health



Health Building Infrastructure
Standard Design Drawings

Job Name:
Primary Hospital Class B
Type 3
RCC frame structure (Brick Masonary)
Two storied

Scale: 1:150

Date : 2073/11/..

Drawing title:

ELEVATIONS

Sheet no:

AR/04



SIDE ELEVATION



SIDE ELEVATION



Management Division
Department of Health Service
Ministry of Health



Health Building Infrastructure
Standard Design Drawings

Job Name:
Primary Hospital Class B
Type 3
RCC frame structure (Brick Masonry)
Two storied

Scale: 1:100

Date : 2073/11/..

Drawing title:

ELEVATIONS

Sheet no:

AR/05

STANDARD HEALTH POST TYPE A



3D
HEALTH POST TYPE A
FRAMED STRUCTURE



FRONT ELEVATION



BACK ELEVATION
HEALTH POST (FRAMED STRUCTURE)

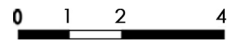

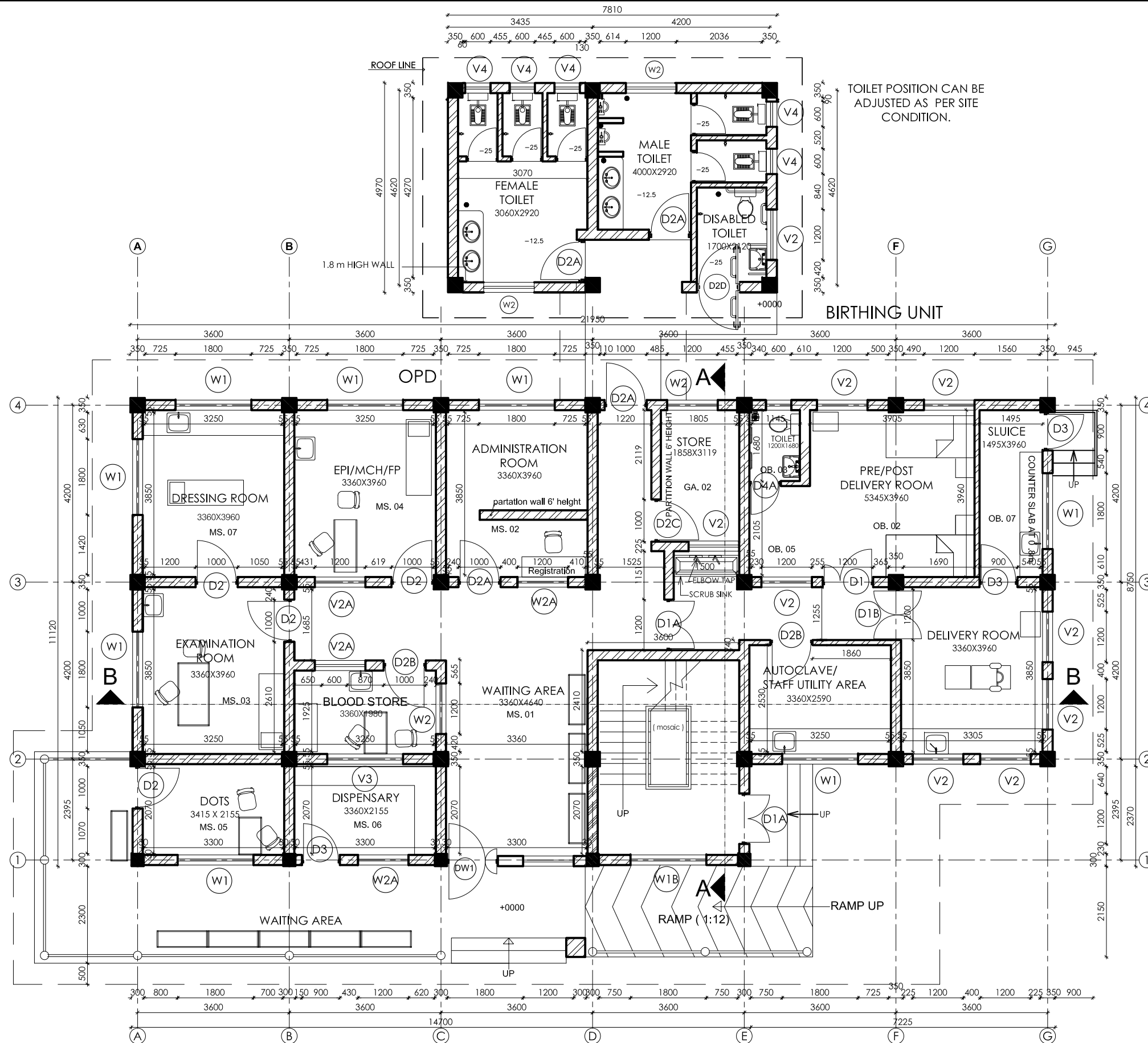

GROUND FLOOR PLAN
 PLINTH AREA : 267.01 sq.m.

Management Division
 Department of Health Service
 Ministry of Health



Health Building Infrastructure
 Standard Design Drawings

Job Name:
 Health Post Type 1, Brick Wall,
 Frame Structure,
 2- storey

Scale: 1:100

Date : 2073/11

Drawing title:
 Ground Floor
 Plan

Sheet no:

AR/01
 HP/F

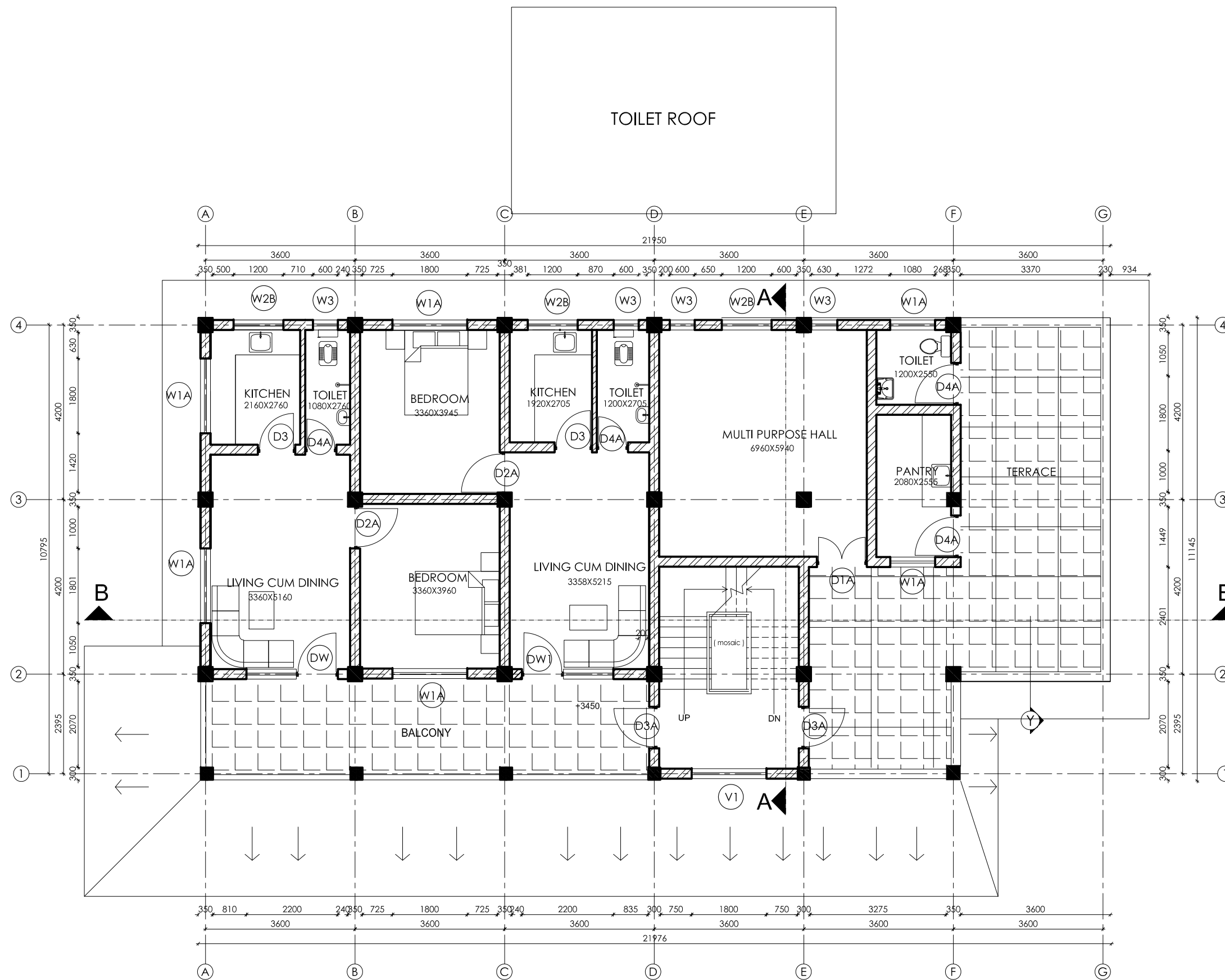

FIRST FLOOR PLAN
 FLOOR AREA = 201.35 sq.m.



Management Division
 Department of Health Service
 Ministry of Health



Health Building Infrastructure
 Standard Design Drawings

Job Name:
 Health Post Type 1, Brick Wall,
 Frame Structure,
 2- storey
 Scale: 1:100
 Date : 2073/11

Drawing title:
 First Floor
 Plan

Sheet no:
 AR/02
 HP/F

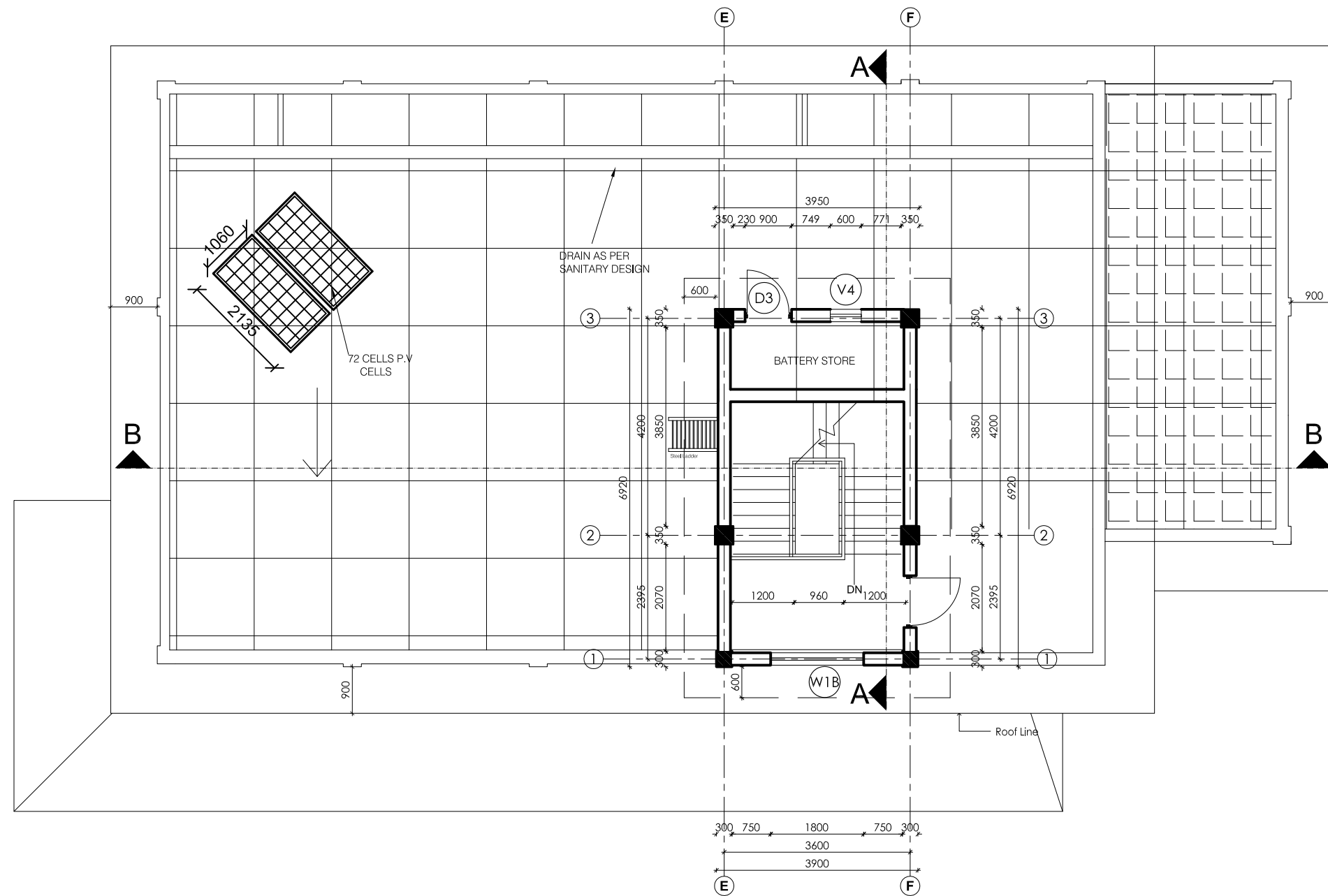

TOP FLOOR PLAN

Management Division
Department of Health Service
Ministry of Health



Health Building Infrastructure
Standard Design Drawings

Job Name:
Health Post Type1, Brick Wall,
Frame Structure,
2- storey

Scale: 1:100

Date : 2073/11

Drawing title:
Top Floor
Plan

Sheet no:

AR/03
HP/F

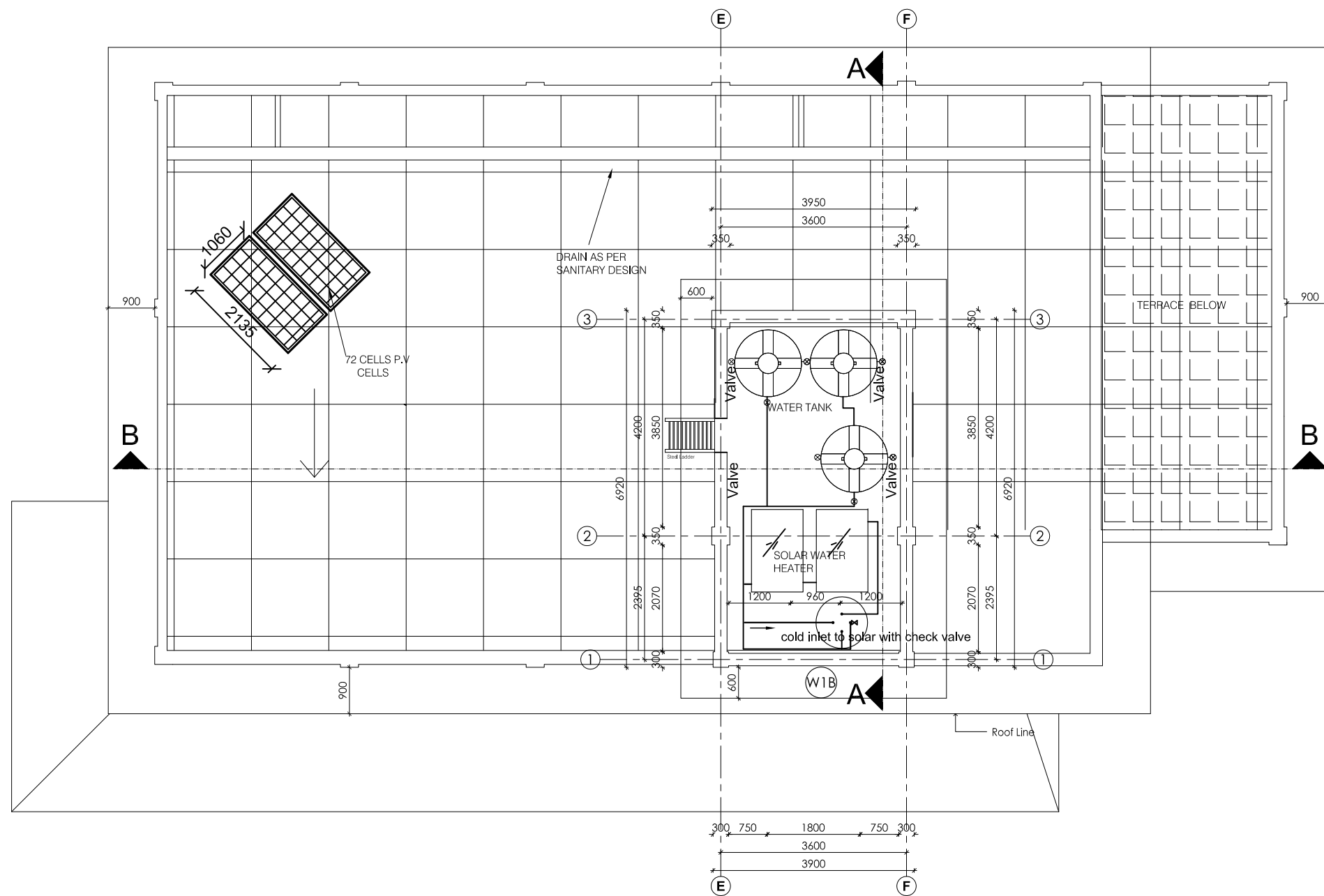

ROOF PLAN

Management Division
Department of Health Service
Ministry of Health



Health Building Infrastructure
Standard Design Drawings

Job Name:
Health Post Type 1, Brick Wall,
Frame Structure,
2- storey

Scale: 1:100

Date : 2073/11

Drawing title:
Roof
Plan

AR/04
HP/F

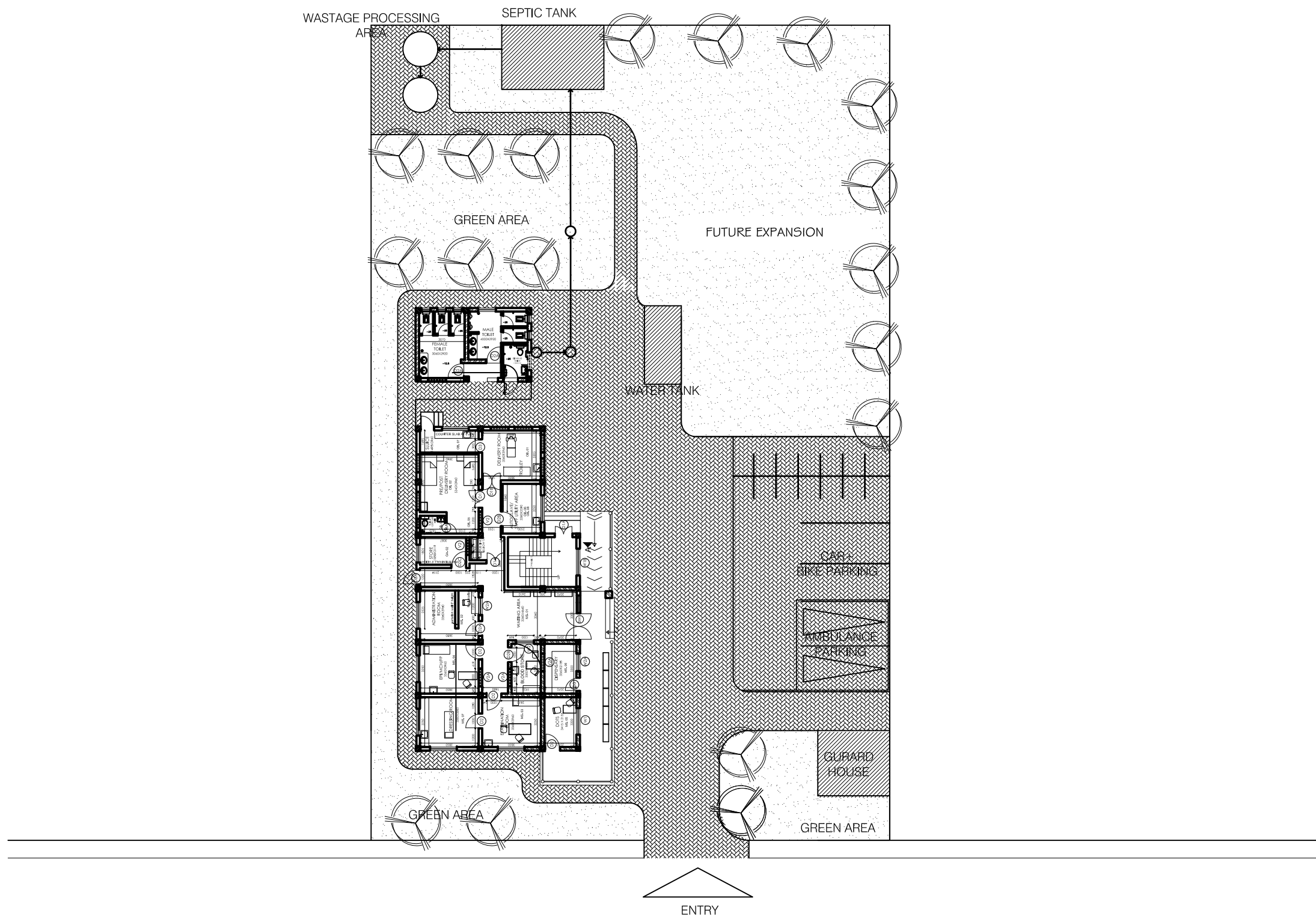

**MODEL SITE PLAN FOR HEALTH POST (STANDARD)
LAND AREA - 2000 SQM (4 ROPANI)**

**Management Division
Department of Health Service
Ministry of Health**



**Health Building Infrastructure
Standard Design Drawings**

Job Name:
Health Post Type 1, Brick Wall,
Frame Structure,
2- storey

Scale: 1:100

Date : 2073/11

Drawing title:
Site Plan

Sheet no:

**AR/05
HP/F**



FRONT ELEVATION



BACK ELEVATION



**Management Division
Department of Health Service
Ministry of Health**



**Health Building Infrastructure
Standard Design Drawings**

Job Name:
Health Post Type 1, Brick Wall,
Frame Structure,
2- storey

Scale: 1:100

Date : 2070/6/7

Drawing title:
Elevations

Sheet no:

**AR/06
HP/F**



SIDE ELEVATION



SIDE ELEVATION



**Management Division
Department of Health Service
Ministry of Health**



**Health Building Infrastructure
Standard Design Drawings**

Job Name:
Health Post Type 1, Brick Wall,
Frame Structure,
2- storey

Scale: 1:100

Date : 2070/6/7

Drawing title:
Elevation and
Section

Sheet no:

**AR/07
HP/F**

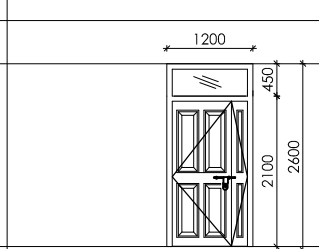
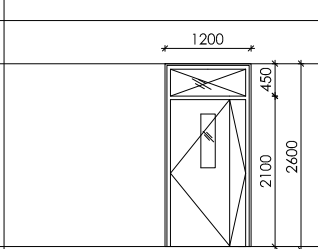
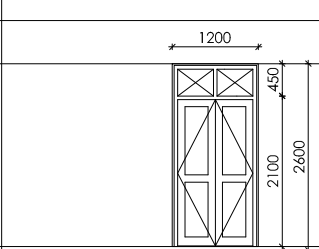
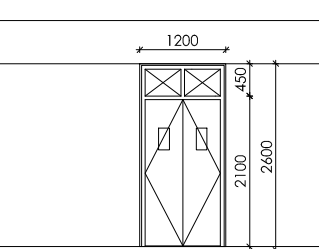
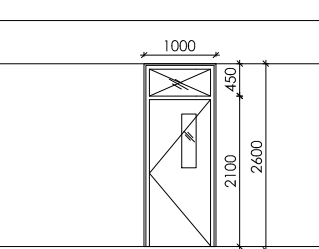
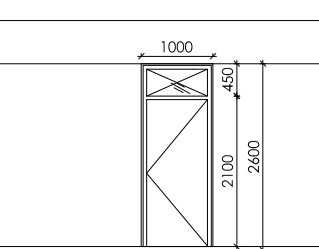
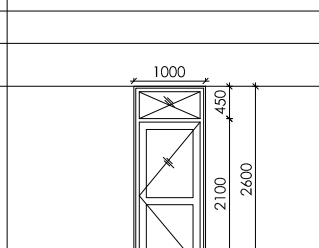
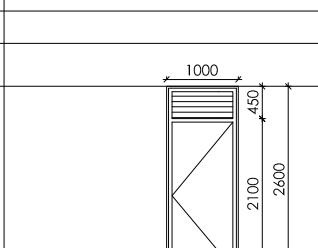
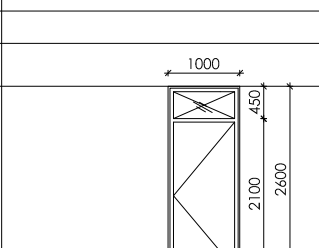
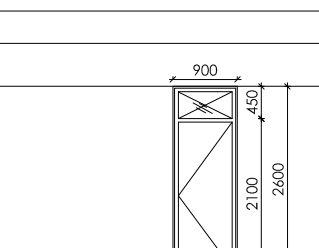
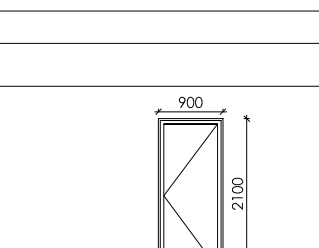
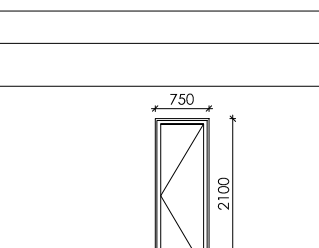
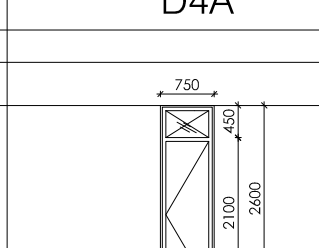
OPENING TYPE	DW1	D1	D1A	D1B	D2	D2A
SHAPE AND SIZE						
QUANTITY	1	1	4	1	4	5
SPECIFICATION	panel double swing door with attached jali door and upper part ventilation	flush door with viewing pane	Flush Door	flush door with viewing pane ; both way swing	flush door with viewing pane	flush door
LOCATION	Main Door	New born corner,pre/post delivery room	corridor, multipurpose hall	delivery room	OPD	Toilet main door ,registration, way to toilet
OPENING TYPE	D2B	D2C	D2D	D3	D3A	D4
SHAPE AND SIZE						
QUANTITY	2	1	1	7	1	4
SPECIFICATION	Upper half Glass, lower half paneled	Flush door	Double Swing flush door	Flush door	Flush door	Flush door
LOCATION	Autoclave, blood bank	store	Disabled Toilet Door	sluice,kitchen,pantry,dispensary	Terrace Door	Inner Toilet Door
OPENING TYPE	D4A					
SHAPE AND SIZE						
QUANTITY	4					
SPECIFICATION	flush door					
LOCATION	attached toilet door					



**Management Division
Department of Health Service
Ministry of Health & Population**



**Health Building Infrastructure
Standard Design Drawings**

Job Name:
Health Post Type 1, Brick Wall,
Frame Structure,
2- storey

Scale: 1:100

Date: 2073/11

Drawing title:
Opening
Schedule

Sheet no:

**AR/08
HP/F**

OPENING TYPE	W1	W1A	W1B	V1	W2	W2A
FLOOR LEVEL LINTEL LEVEL SHAPE AND SIZE FLOOR FINISH LEVEL STRUCTURE LEVEL						
QUANTITY	8	8	2	2	4	2
SPECIFICATION	SLIDING	SLIDING	SLIDING	SLIDING	SLIDING	SLIDING
LOCATION	GROUND FLOOR	FIRST FLOOR			GROUND FLOOR	GROUND FLOOR
OPENING TYPE	W2B	V2	V2A	W3	V3	V4
FLOOR LEVEL LINTEL LEVEL SHAPE AND SIZE FLOOR FINISH LEVEL STRUCTURE LEVEL						
QUANTITY	3	9	3	5	3	1
SPECIFICATION	SLIDING	SLIDING	FIXED	MOVABLE	MOVABLE	
LOCATION	FIRST FLOOR	GROUND FLOOR		GROUND FLOOR		



Management Division
 Department of Health Service
 Ministry of Health & Population



Health Building Infrastructure
 Standard Design Drawings

Job Name:
 Health Post Type 1, Brick Wall,
 Frame Structure,
 2- storey

Scale: 1:100

Date : 2073/11

Drawing title:
 Opening
 Schedule

Sheet no:

AR/9
 HP/F

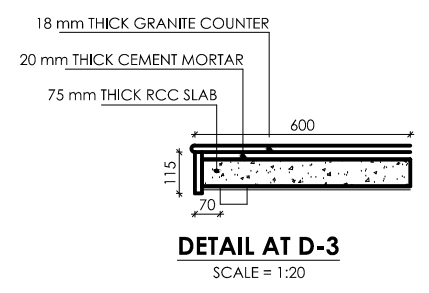
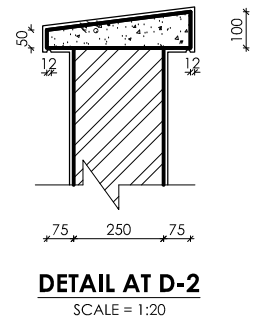
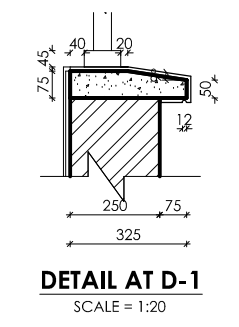
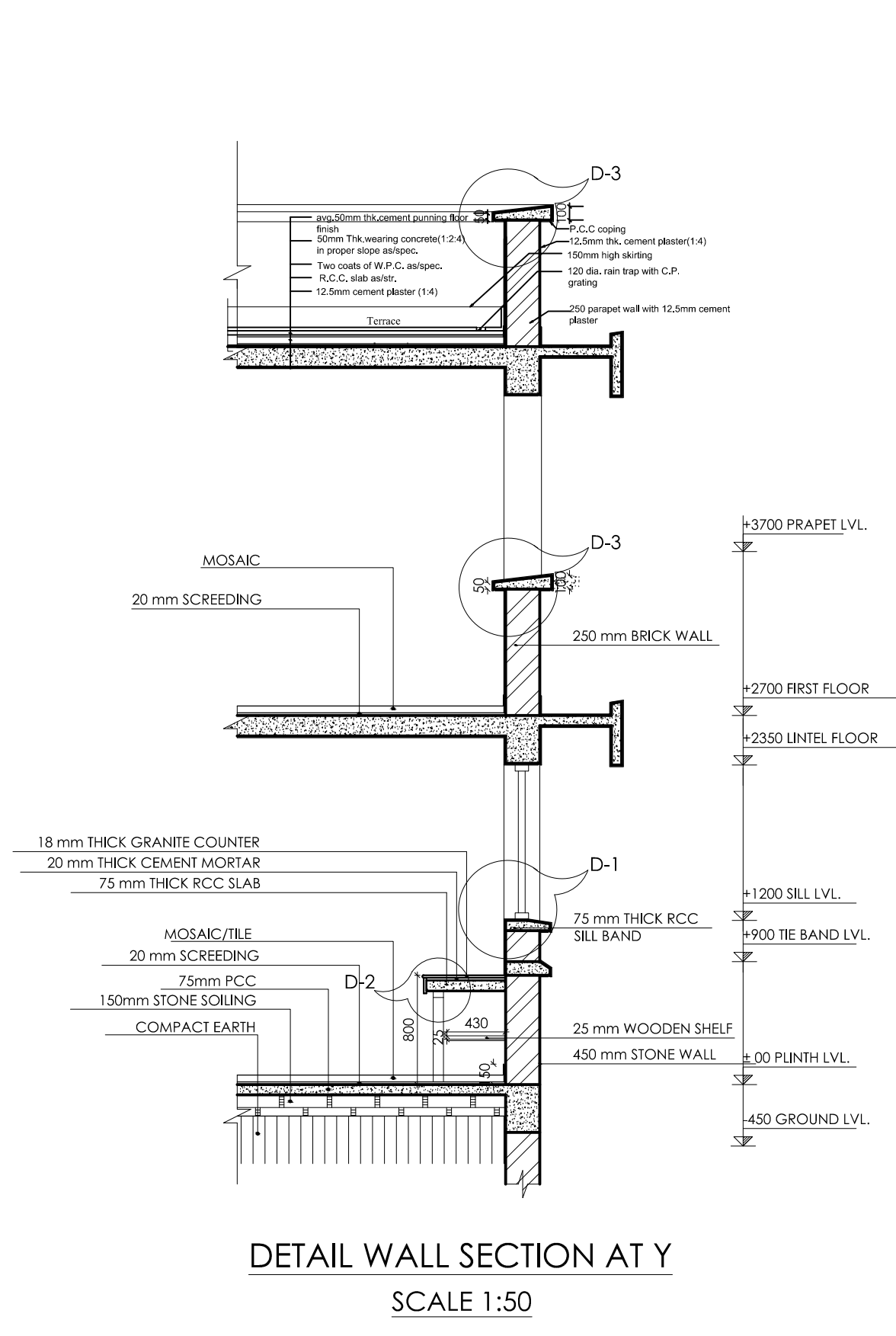
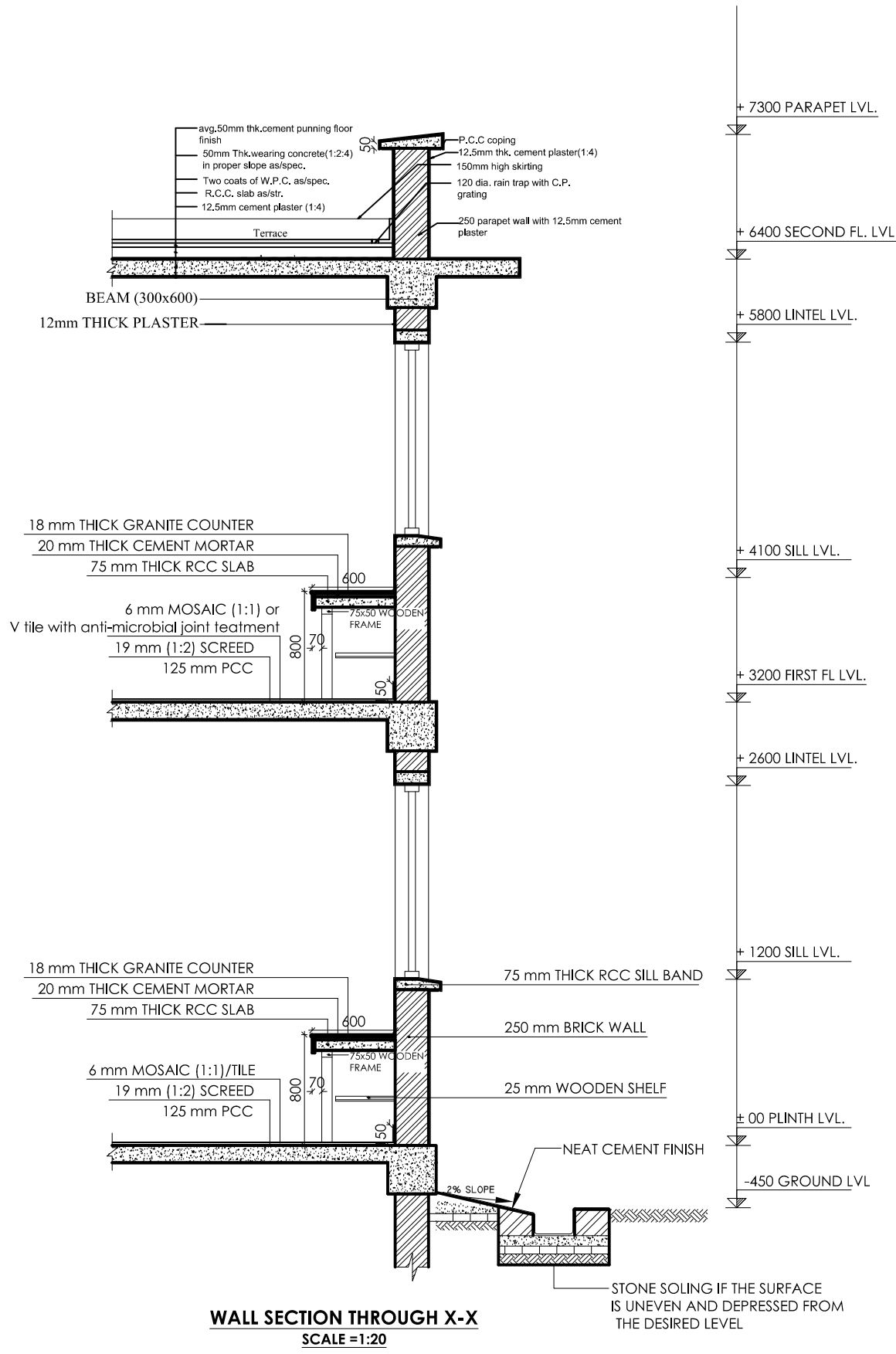

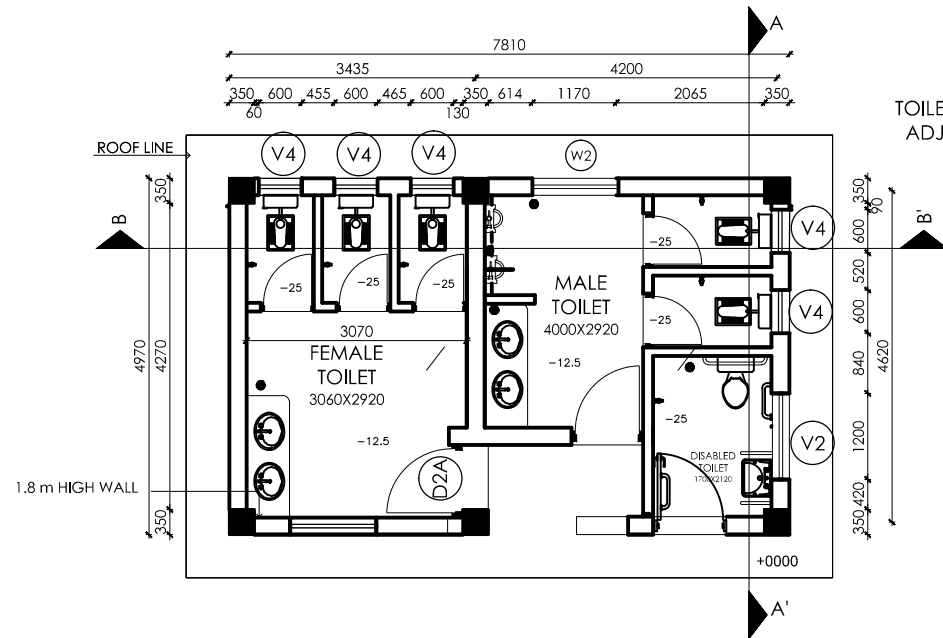

1.8 m HIGH WALL

TOILET POSITION CAN BE ADJUSTED AS PER SITE CONDITION.

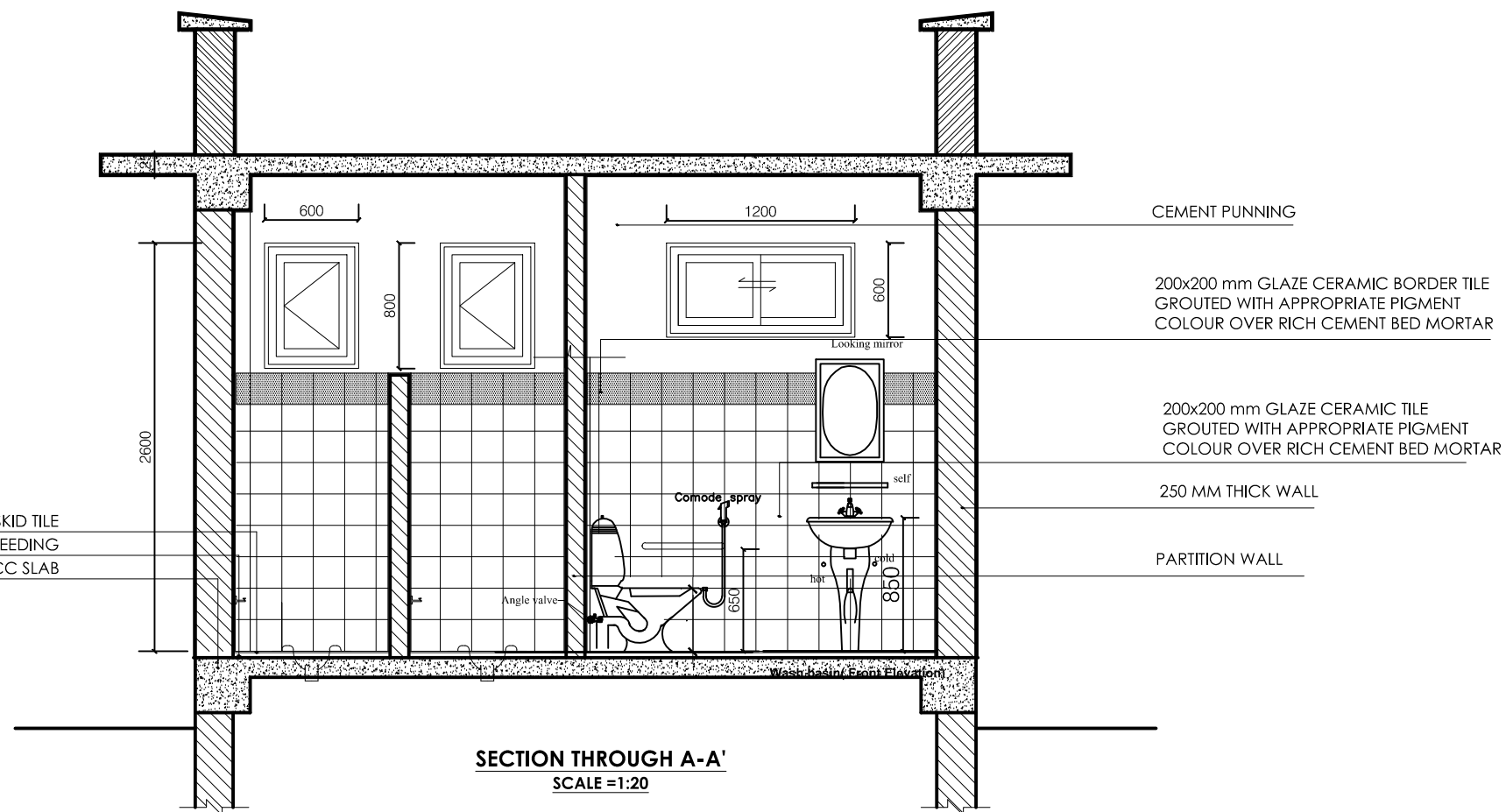

NON SKID TILE
32mm THICK SCREEDING
125 mm THICK PCC SLAB

CEMENT PUNNING
200x200 mm GLAZE CERAMIC BORDER TILE
GROUTED WITH APPROPRIATE PIGMENT
COLOUR OVER RICH CEMENT BED MORTAR
200x200 mm GLAZE CERAMIC TILE
GROUTED WITH APPROPRIATE PIGMENT
COLOUR OVER RICH CEMENT BED MORTAR
250 MM THICK WALL
PARTITION WALL

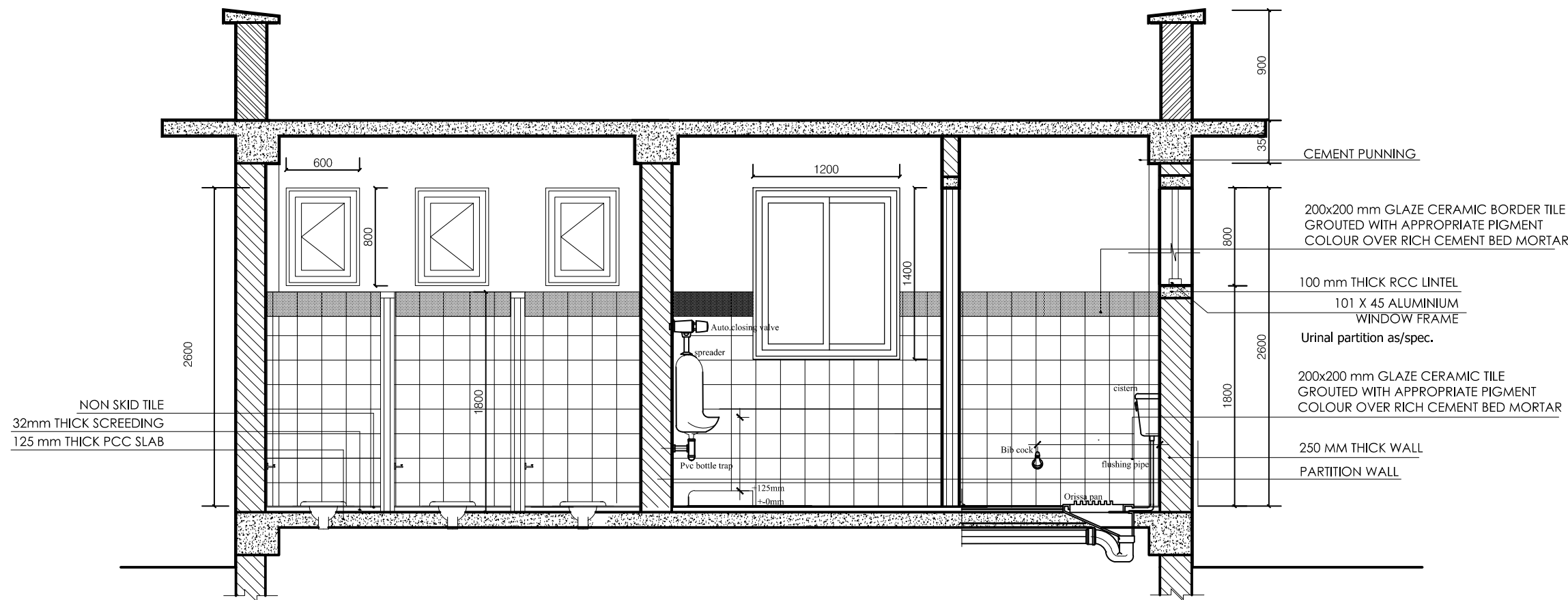

NON SKID TILE
32mm THICK SCREEDING
125 mm THICK PCC SLAB

CEMENT PUNNING
200x200 mm GLAZE CERAMIC BORDER TILE
GROUTED WITH APPROPRIATE PIGMENT
COLOUR OVER RICH CEMENT BED MORTAR
100 mm THICK RCC LINTEL
101 X 45 ALUMINIUM
WINDOW FRAME
Urinal partition as/spec.
200x200 mm GLAZE CERAMIC TILE
GROUTED WITH APPROPRIATE PIGMENT
COLOUR OVER RICH CEMENT BED MORTAR
250 MM THICK WALL
PARTITION WALL



Management Division
Department of Health Service
Ministry of Health & Population



Health Building Infrastructure
Standard Design Drawings

Job Name:
Health Post Type 1, Brick Wall,
Frame Structure,
2- storey

Scale: 1:100

Date: 2073/11

Drawing title:
Toilet Details

Sheet no:

AR/11
HP/F

**STANDARD HEALTH POST
TYPE B**



3D
HEALTH POST TYPE B

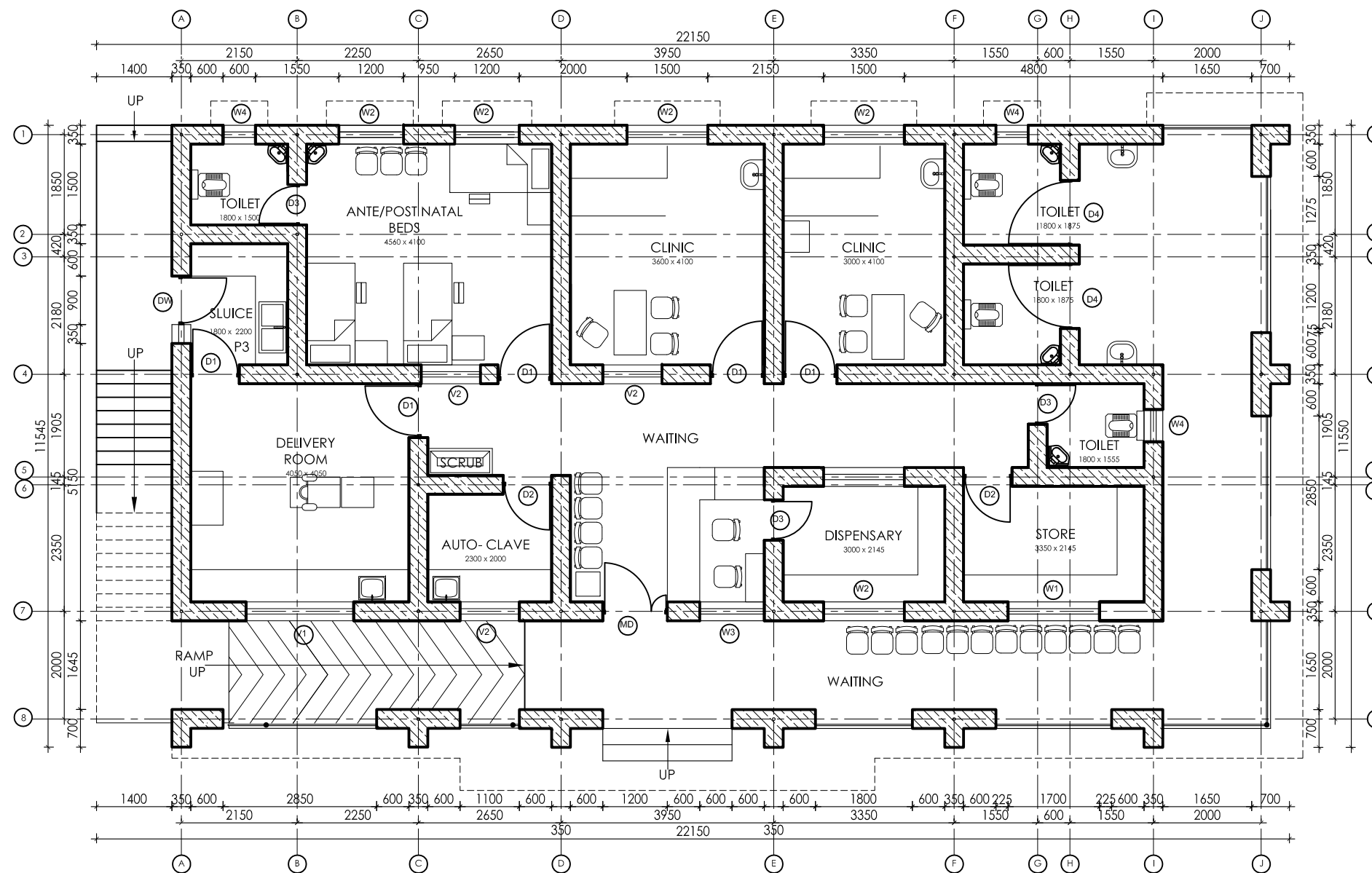

GROUND FLOOR PLAN

FURNITURE LAYOUT, TYPE -1

Area:169.28 Sq. M.(EXCLUDING COVERED VARANDAH)

Management Division
Department of Health Service
Ministry of Health



Health Building Infrastructure
Standard Design Drawings

Job Name:
STANDARD HEALTH POST TYPE 2
(For population upto 7001 to 12000)
STONE MASONRY
TWO STORIED

Scale: 1:100

Date : 2073/9/14

Drawing title:
GROUND FLOOR
PLAN WITH
FURNITURE
LAYOUT

Sheet no:

AR/01

HP/2

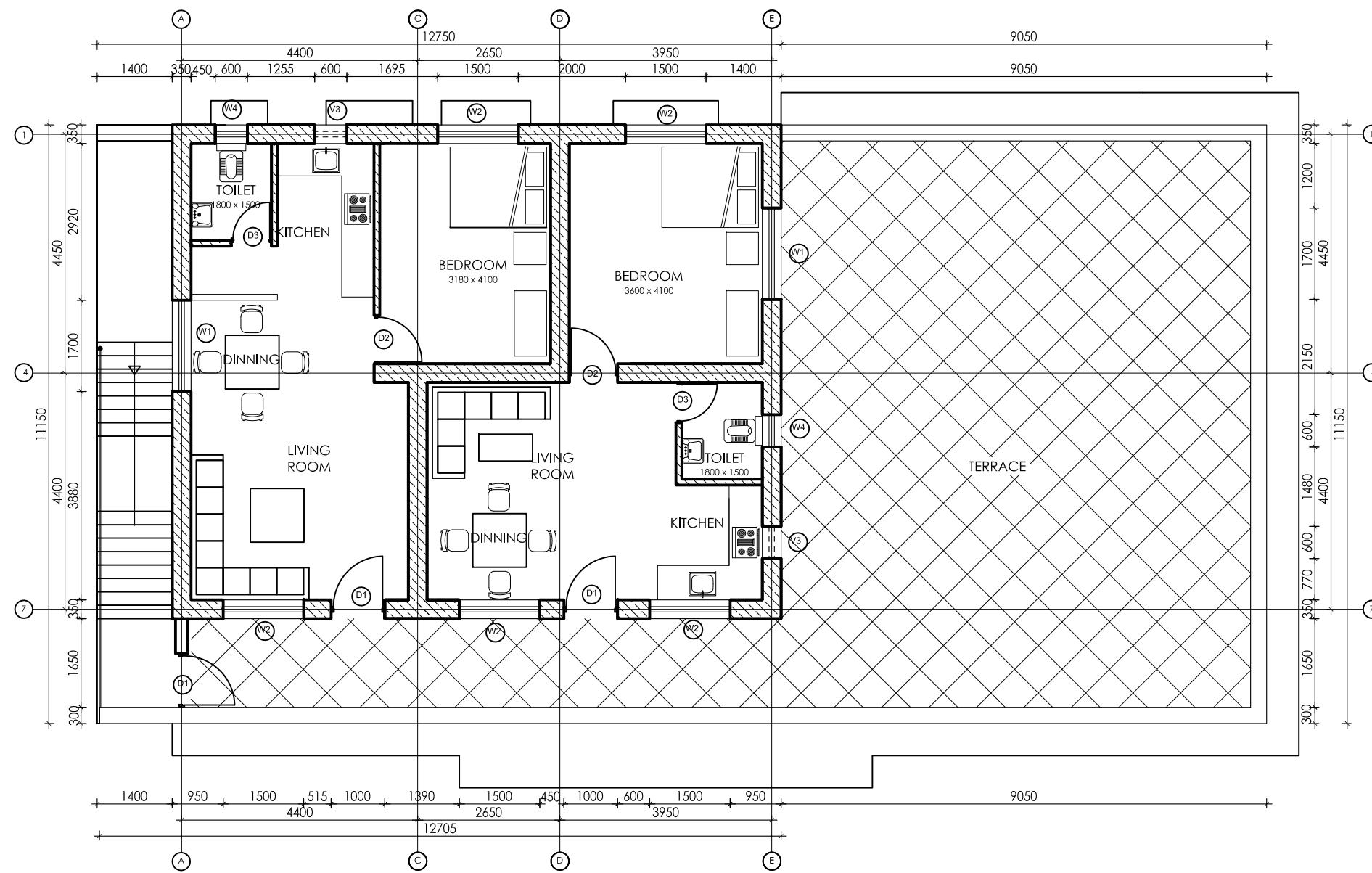

FIRST FLOOR PLAN

Area: 10.44 Sq. M. (EXCLUDING COVERED VARANDAH)

Management Division
Department of Health Service
Ministry of Health



Health Building Infrastructure
Standard Design Drawings

Job Name:
STANDARD HEALTH POST TYPE 2
(For population upto 7001 to 12000)
STONE MASONRY
TWO STORIED

Scale: 1:100

Date : 2073/9/14

Drawing title:
FIRST FLOOR
PLAN WITH
FURNITURE
LAYOUT

Sheet no:

AR/02

HP/2



FRONT ELEVATION

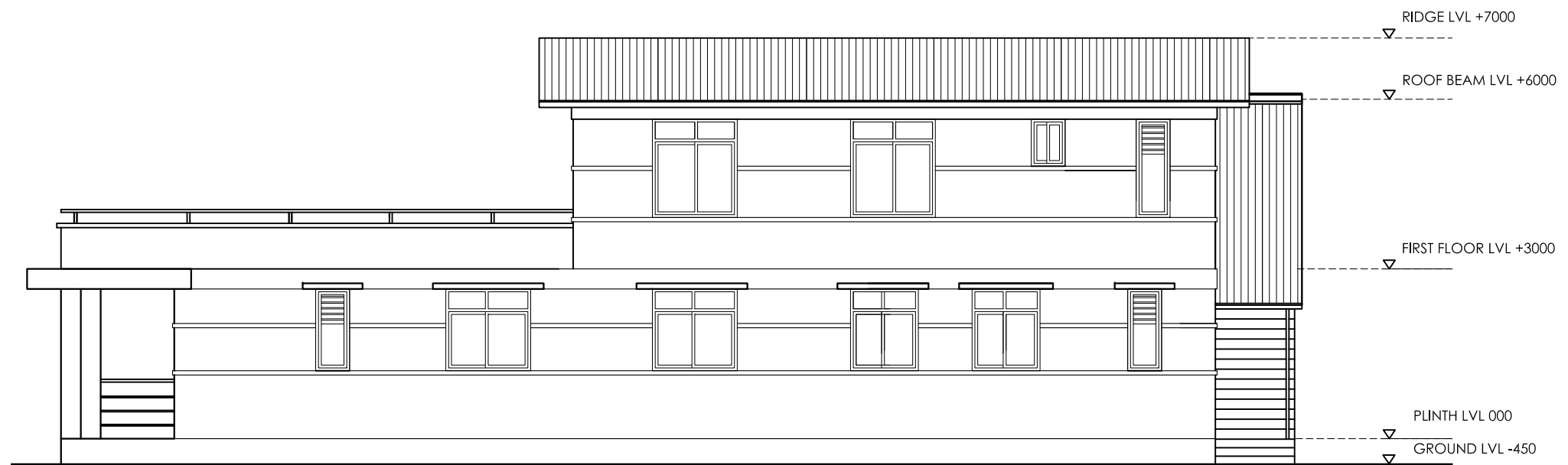

BACK ELEVATION

Management Division
Department of Health Service
Ministry of Health



Health Building Infrastructure
Standard Design Drawings

Job Name:
STANDARD HEALTH POST TYPE 2
(For population upto 7001 to 12000)
STONE MASONRY
TWO STORED

Scale: 1:100

Date : 2073/9/14

Drawing title:
ELEVATIONS

Sheet no:

AR/03

HP/2

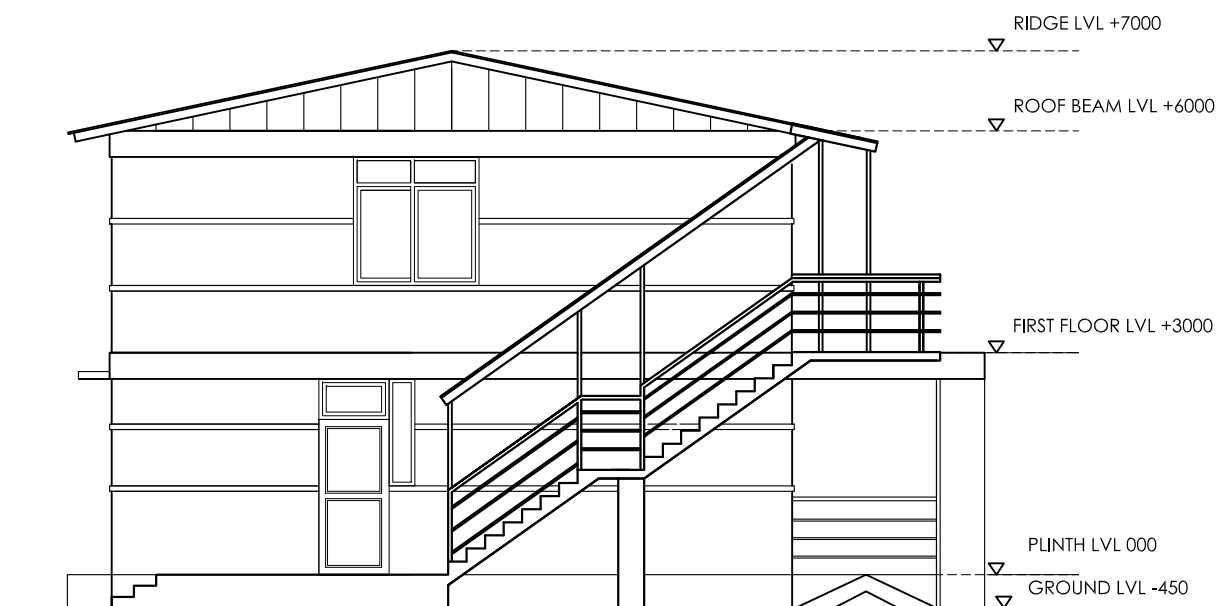

SIDE ELEVATION



SIDE ELEVATION



Management Division
Department of Health Service
Ministry of Health



Health Building Infrastructure
Standard Design Drawings

Job Name:
STANDARD HEALTH POST TYPE 2
(For population upto 7001 to 12000)
STONE MASONRY
TWO STORIED

Scale: 1:100

Date : 2073/9/14

Drawing title:

ELEVATIONS

Sheet no:

AR/04

HP/2

STANDARD HEALTH POST TYPE C

3D HEALTH POST TYPE C



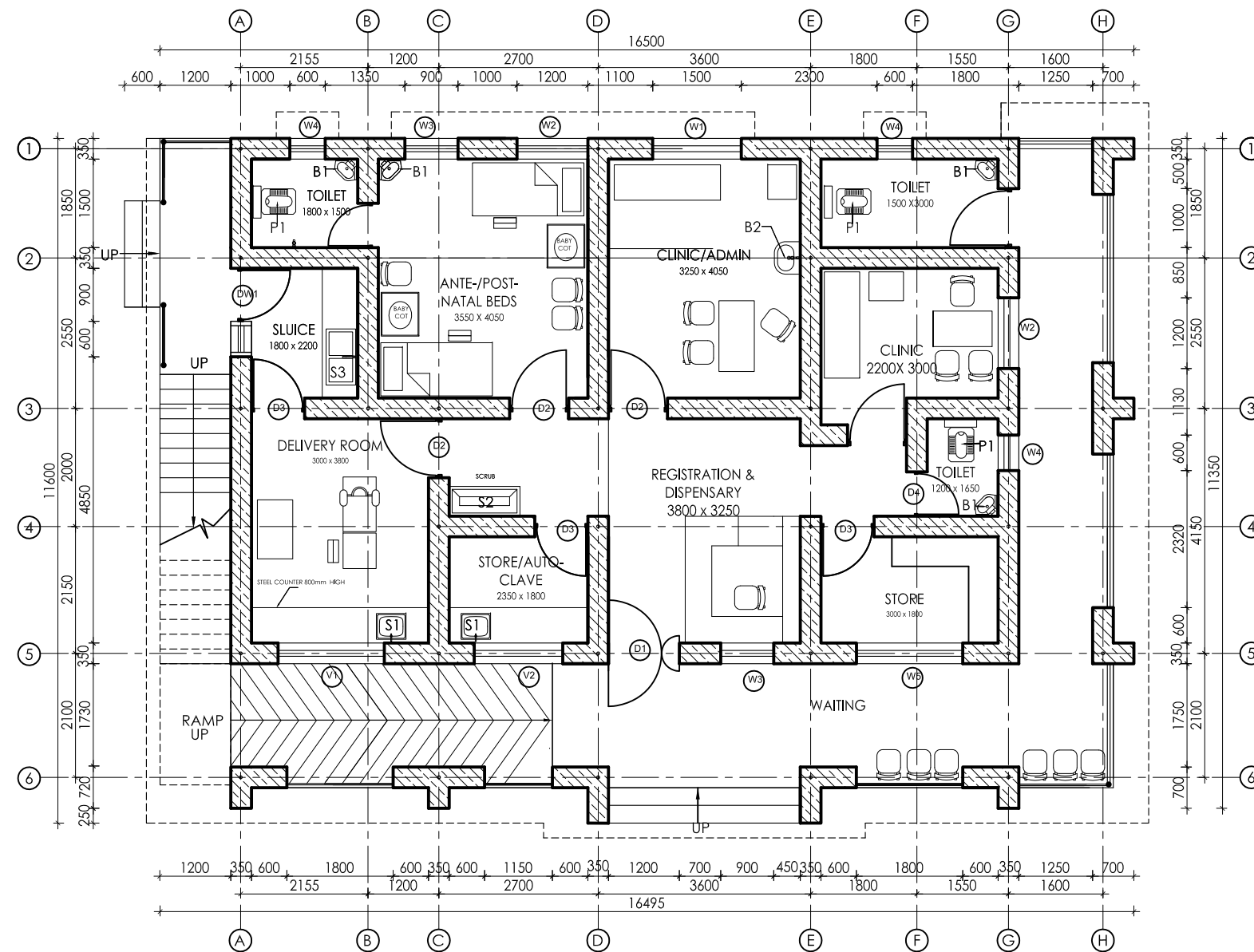

GROUND FLOOR PLAN

Area: 118.8 Sq. M.(EXCLUDING COVERED VARANDAH)

HEALTH POST TYPE DESIGN -3

Management Division
Department of Health Service
Ministry of Health



Health Building Infrastructure
Standard Design Drawings

Job Name:
STANDARD HEALTH POST TYPE 3
(For population upto 3001 to 7000)
STONE MASONRY
TWO STORIED

Scale: 1:100

Date : 2073/9/14

Drawing title:
GROUND FLOOR
PLAN WITH
FURNITURE
LAYOUT

Sheet no:

AR/01

HP/3

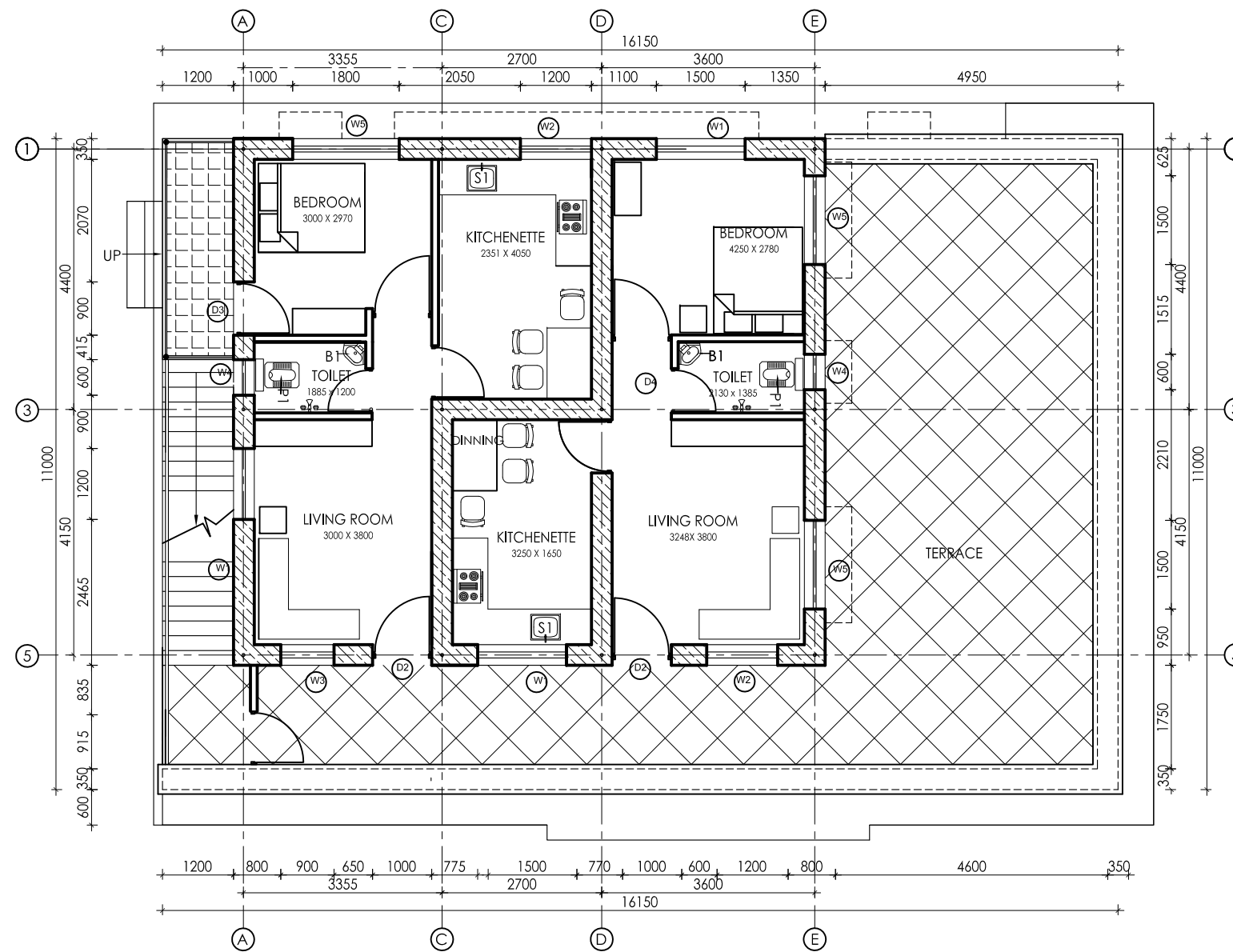

FIRST FLOOR PLAN

Area: 88.9 Sq. M.(EXCLUDING COVERED VARANDAH)

HEALTH POST TYPE DESIGN -3

Management Division
Department of Health Service
Ministry of Health



Health Building Infrastructure
Standard Design Drawings

Job Name:
STANDARD HEALTH POST TYPE 3
(For population upto 3001 to 7000)
STONE MASONRY
TWO STORIED

Scale: 1:100

Date : 2073/9/14

Drawing title:
FIRST FLOOR
PLAN WITH
FURNITURE
LAYOUT

Sheet no:

AR/02

HP/3

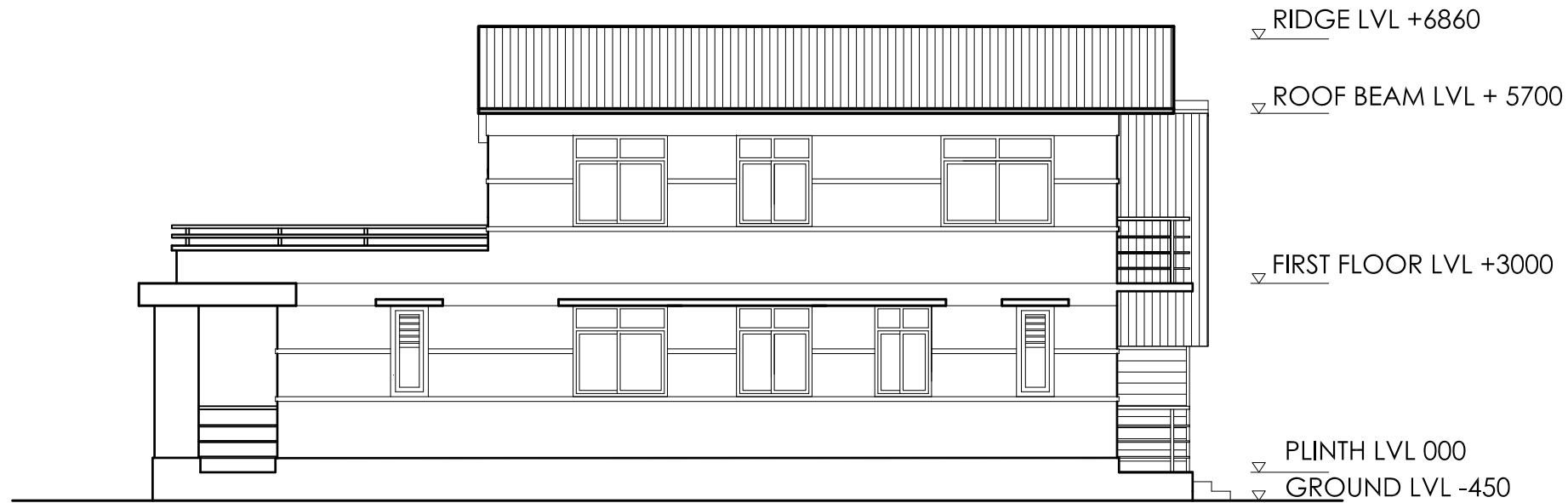

BACK ELEVATION



SIDE ELEVATION - 1



FRONT ELEVATION



SIDE ELEVATION - 2



Management Division
Department of Health Service
Ministry of Health



Health Building Infrastructure
Standard Design Drawings

Job Name:
STANDARD HEALTH POST TYPE 3
(For population upto 3001 to 7000)
STONE MASONRY
TWO STORED

Scale: 1:100

Date : 2073/9/14

Drawing title:

ELEVATIONS

Sheet no:

AR/03

HP/3

STANDARD HEALTH POST TYPE D

**3D
HEALTH POST TYPE D**



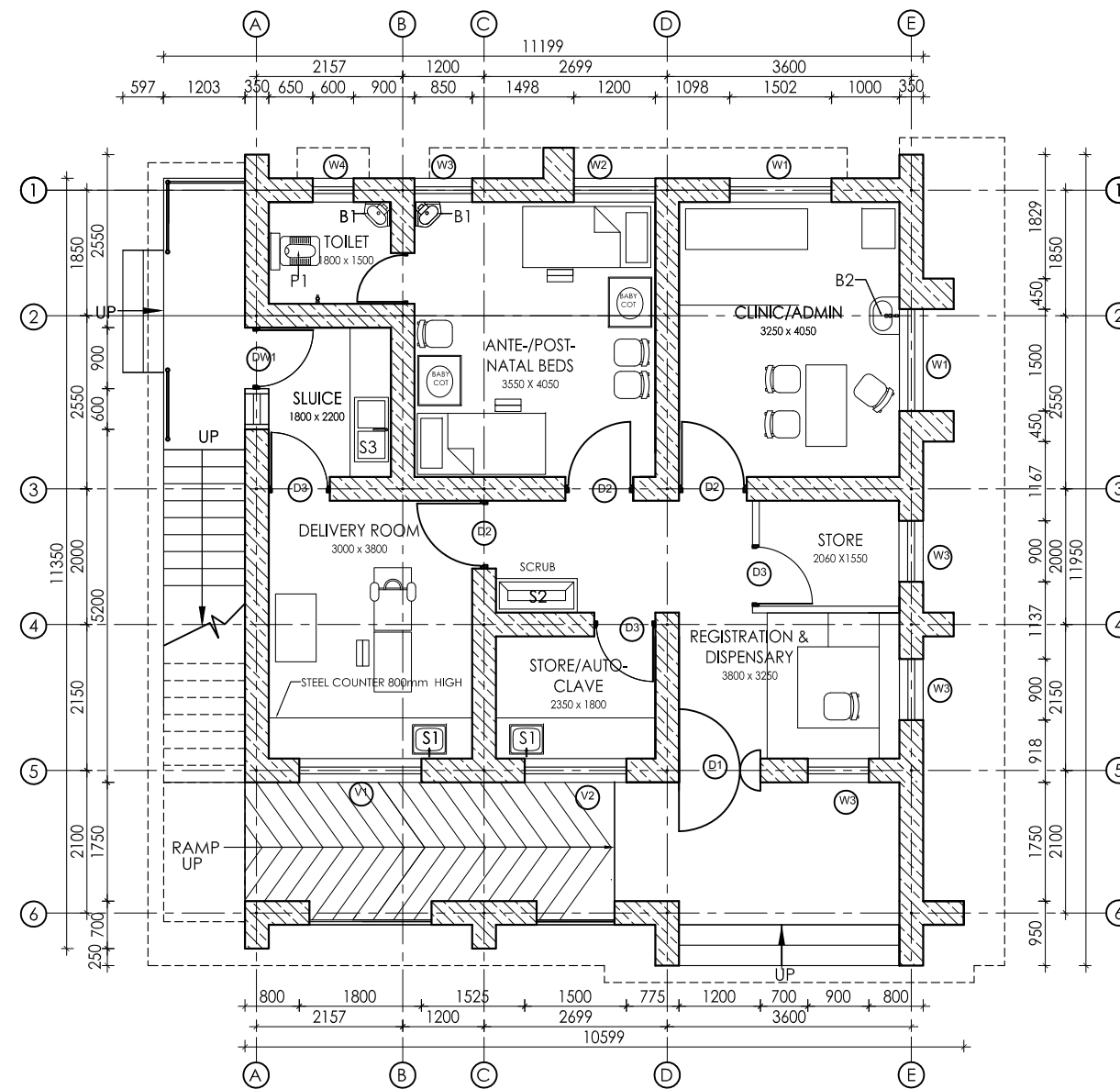

GROUND FLOOR PLAN

Area: 113.81 Sq. M.

HEALTH POST TYPE DESIGN - 4

Management Division
Department of Health Service
Ministry of Health



Health Building Infrastructure
Standard Design Drawings

Job Name:
STANDARD HEALTH POST TYPE 4
(For population upto 3000)
STONE MASONRY
TWO STORIED

Scale: 1:100

Date: 2073/9/14

Drawing title:
GROUND FLOOR
PLAN WITH
FURNITURE
LAYOUT

Sheet no:

AR/01

HP/4

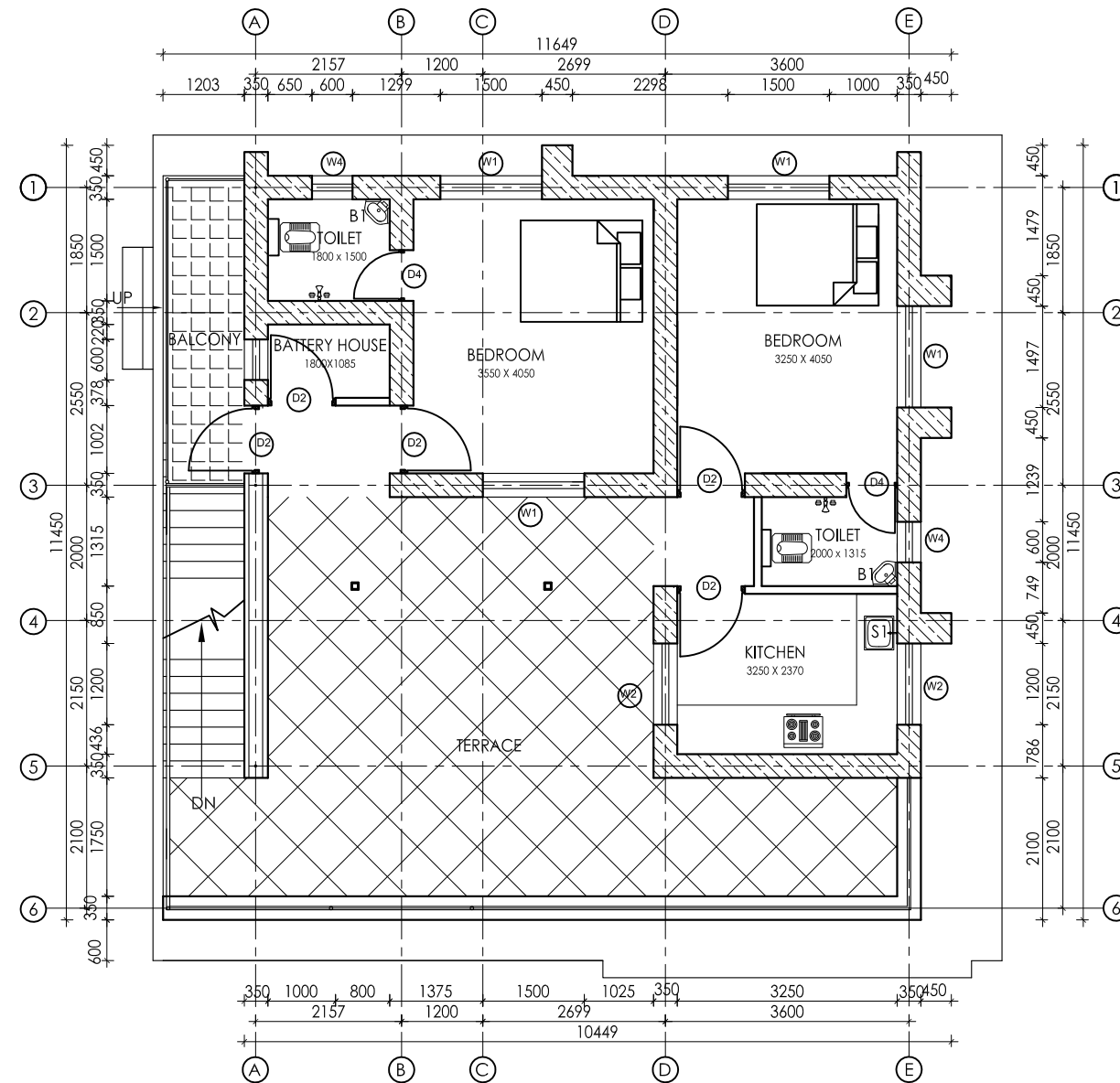

FIRST FLOOR PLAN

Area: 76.82 Sq. M.(EXCLUDING COVERED VARANDAH)

HEALTH POST TYPE DESIGN - 4

Management Division
Department of Health Service
Ministry of Health



Health Building Infrastructure
Standard Design Drawings

Job Name:
STANDARD HEALTH POST TYPE 4
(For population upto 3000)
STONE MASONRY
TWO STORIED

Scale: 1:100

Date : 2073/9/14

Drawing title:
FIRST FLOOR
PLAN WITH
FURNITURE
LAYOUT

Sheet no:

AR/02

HP/4

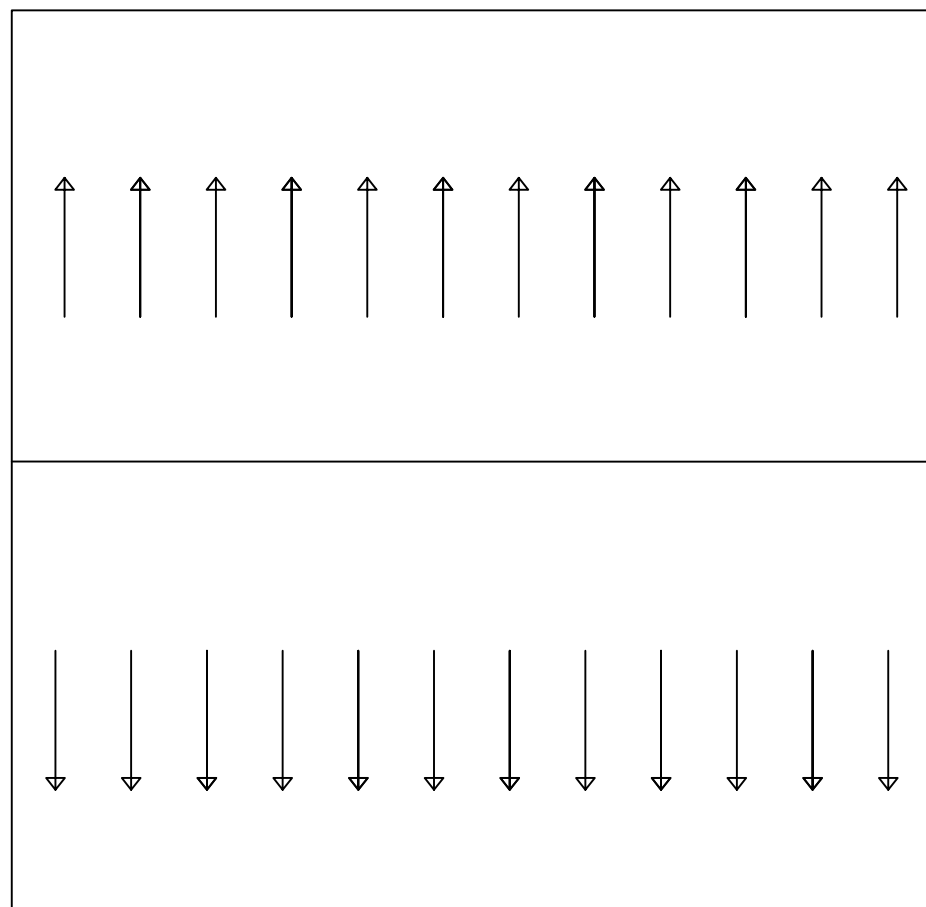

ROOF PLAN

HEALTH POST TYPE DESIGN - 4



Management Division
Department of Health Service
Ministry of Health



Health Building Infrastructure
Standard Design Drawings

Job Name:
STANDARD HEALTH POST TYPE 4
(For population upto 3000)
STONE MASONRY
TWO STORIED

Scale: 1:100

Date : 2073/9/14

Drawing title:

ROOF PLAN

Sheet no:

AR/03

HP/4



SIDE ELEVATION - 2

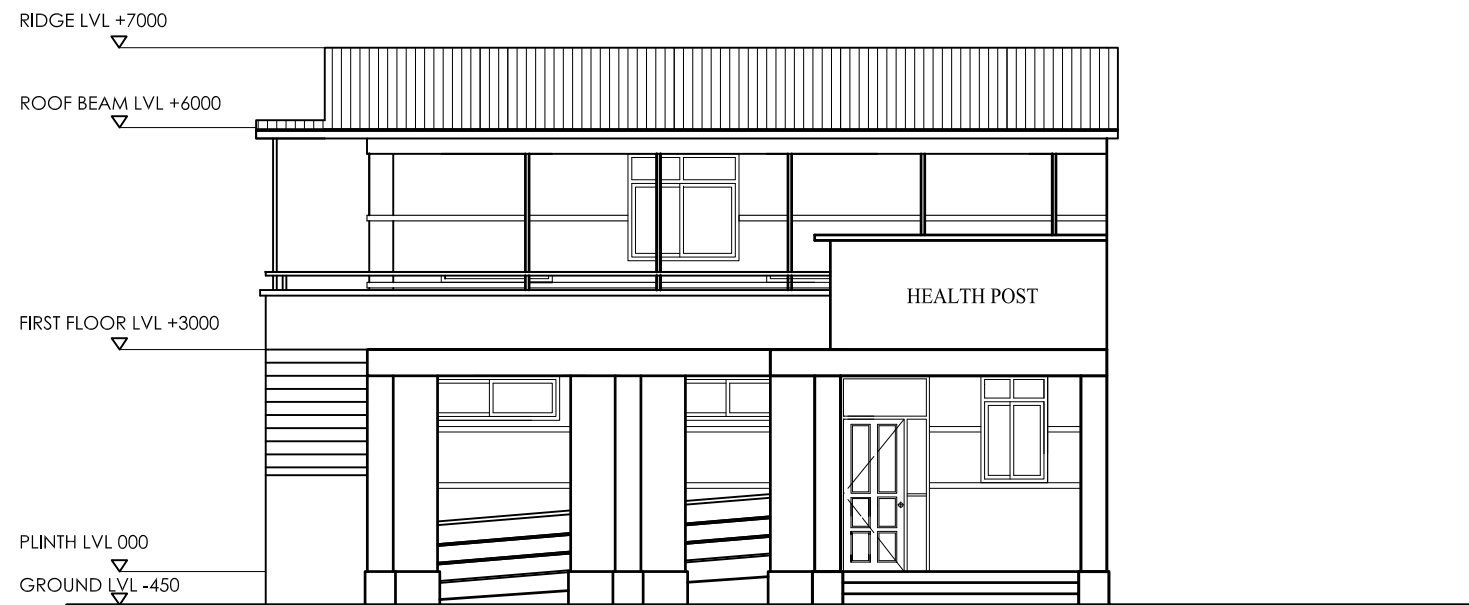

FRONT ELEVATION



Management Division
Department of Health Service
Ministry of Health



Health Building Infrastructure
Standard Design Drawings

Job Name:
STANDARD HEALTH POST TYPE 4
(For population upto 3000)
STONE MASONRY
TWO STORIED

Scale: 1:100

Date : 2073/9/14

Drawing title:

ELEVATIONS

Sheet no:

AR/04

HP/4

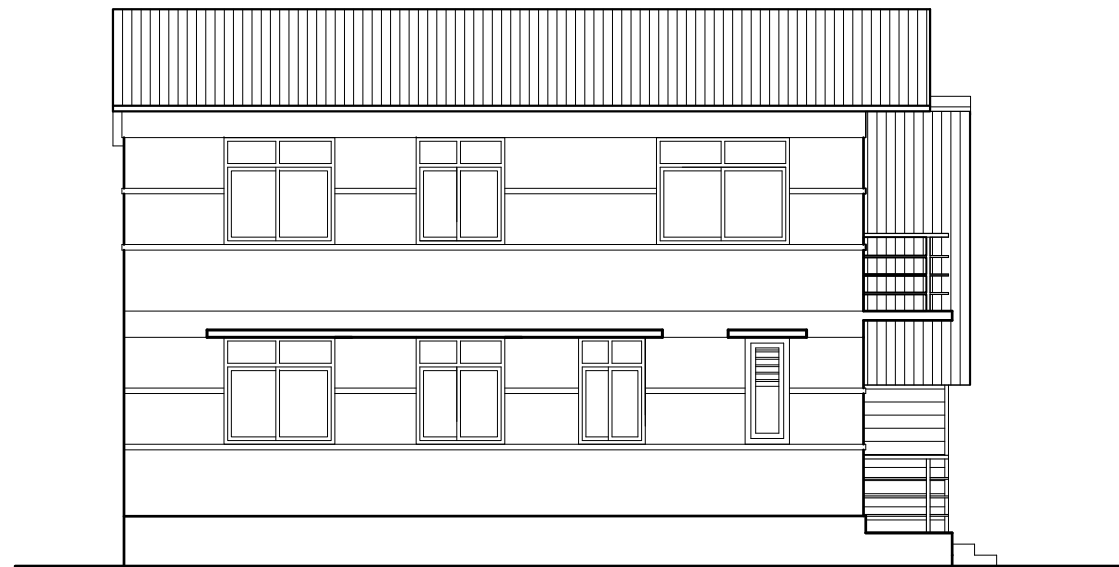

BACK ELEVATION

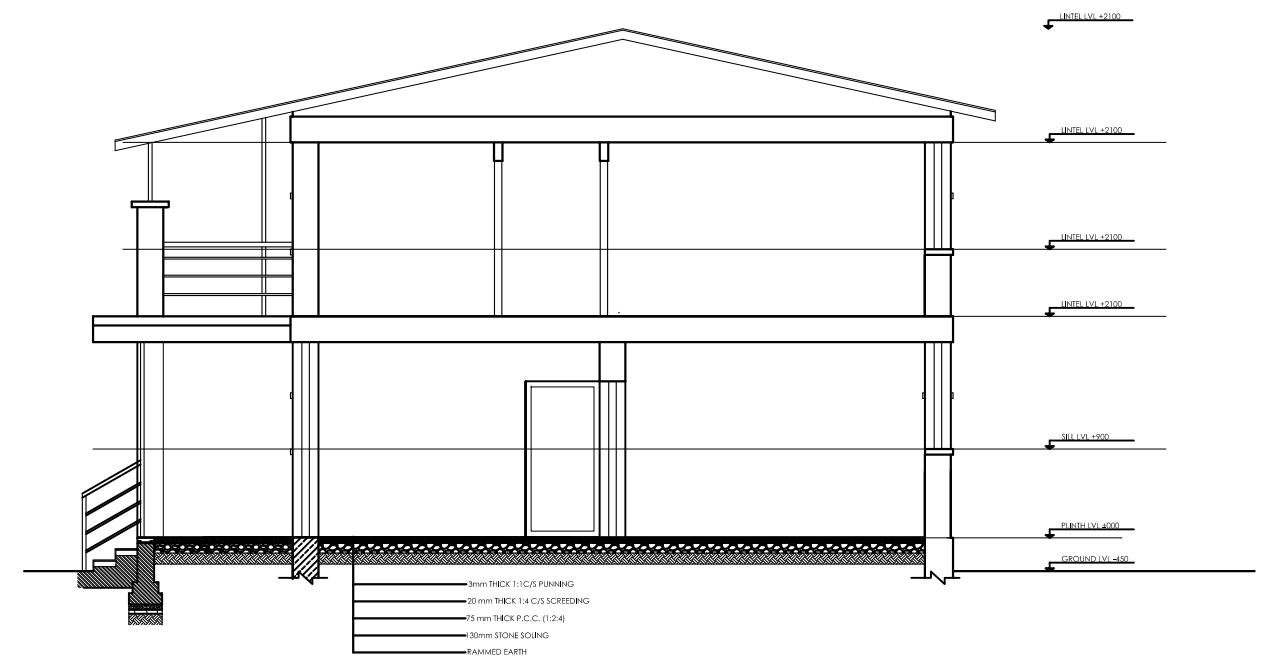

SECTION AT A-A'
HEALTH POST TYPE DESIGN - 4



SIDE ELEVATION - 1



Management Division
Department of Health Service
Ministry of Health



Health Building Infrastructure
Standard Design Drawings

Job Name:
STANDARD HEALTH POST TYPE 4
(For population upto 3000)
STONE MASONRY
TWO STORIED

Scale: 1:100

Date : 2073/9/14

Drawing title:
ELEVATIONS
AND SECTION

Sheet no:

AR/05

HP/4

CANTEEN

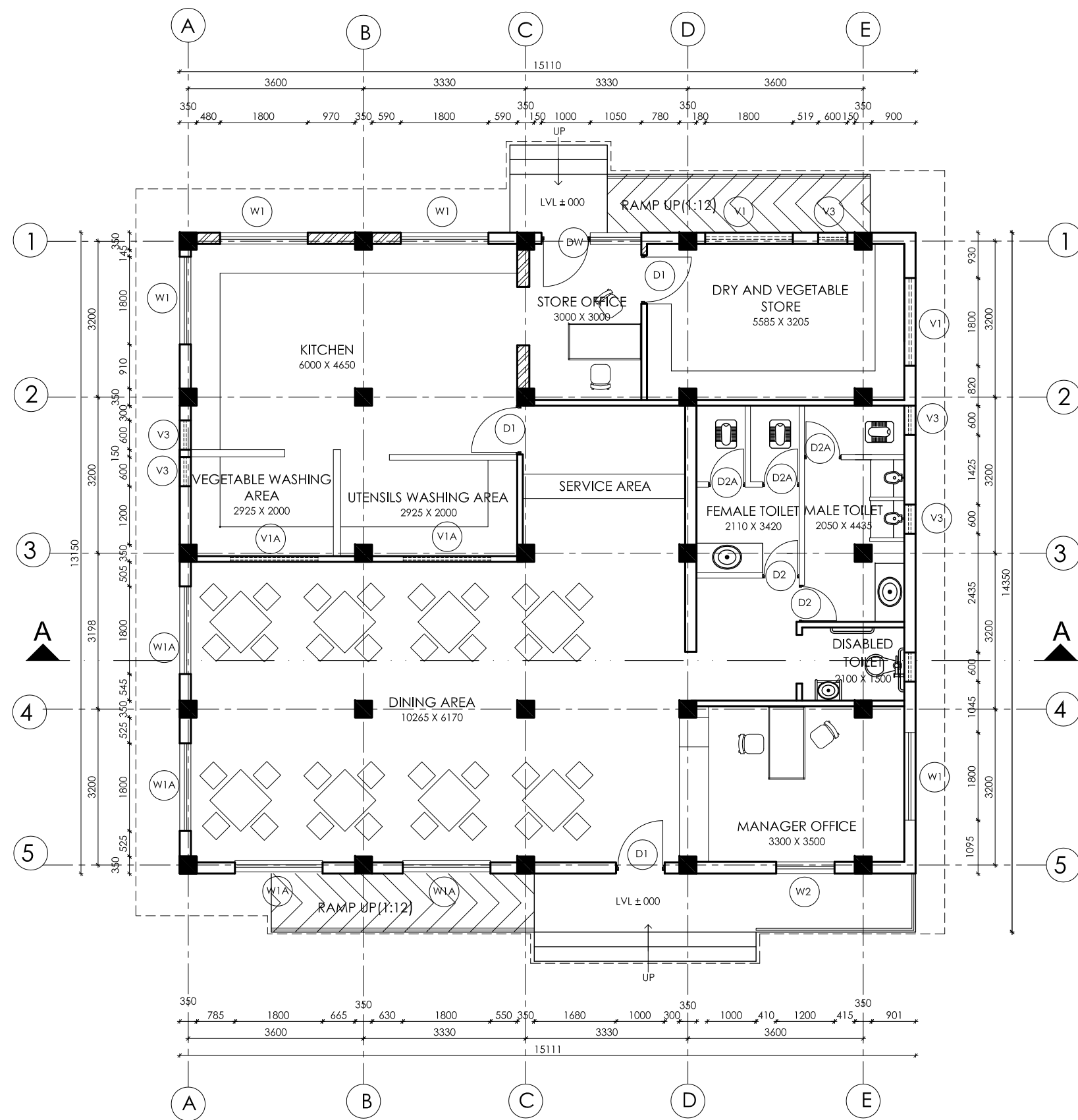

GROUND FLOOR PLAN

186.36 sq.m.

Management Division
Department of Health Service
Ministry of Health & Population



Health Building Infrastructure
Standard Design Drawings

Job Name:

HOSPITAL CANTEEN
Brick / Single storied

Scale: 1:100

Date : 2070/6/7

Drawing title:
Floor Plans lw
Furniture Layout

Sheet no:

AR/01
C/H



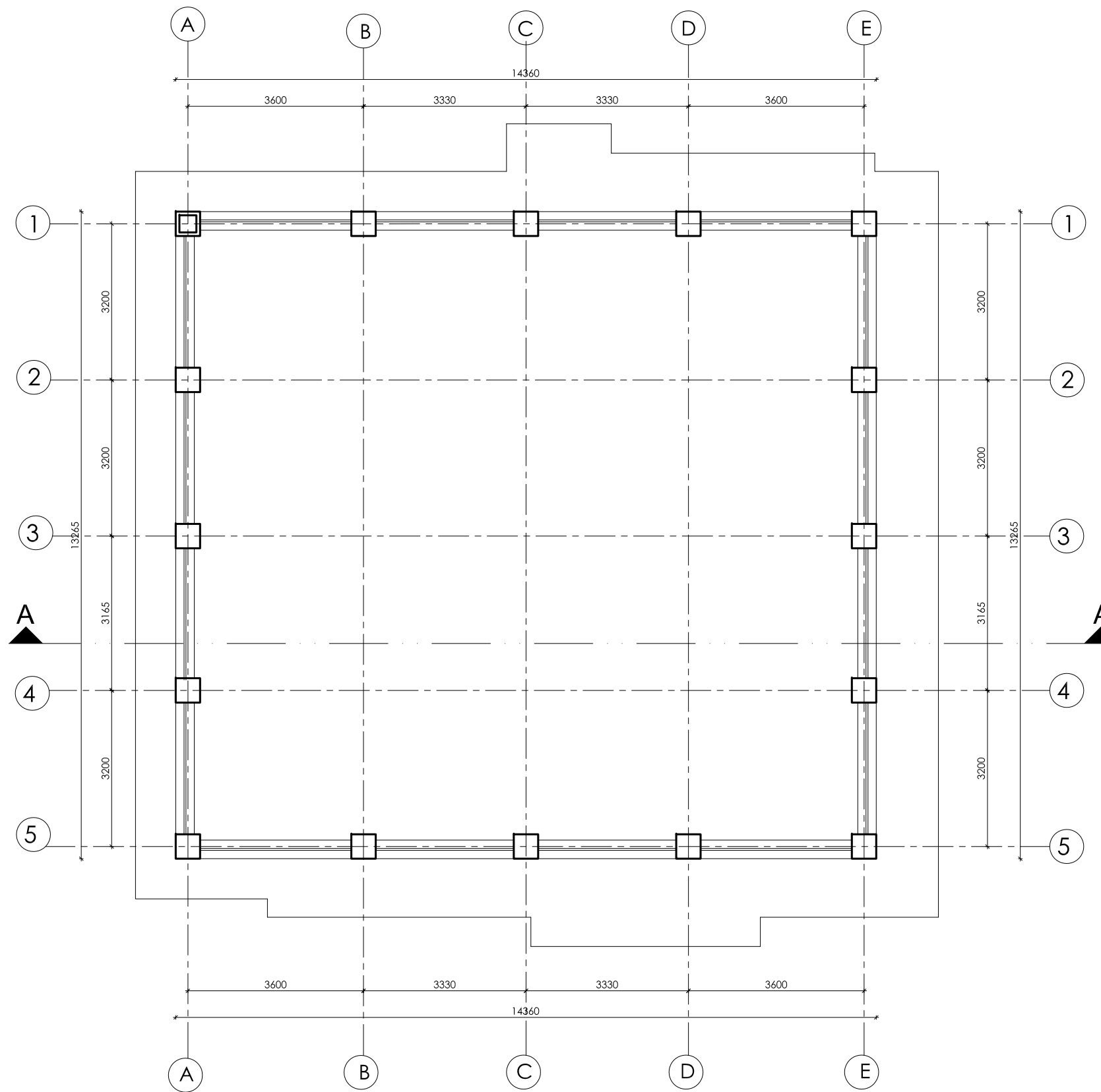

ROOF PLAN



**Management Division
Department of Health Service
Ministry of Health & Population**



**Health Building Infrastructure
Standard Design Drawings**

Job Name:
HOSPITAL CANTEEN
Brick / Single storied

Scale: 1:100

Date : 2070/6/7

Drawing title:
Roof plan

Sheet no:

AR/02
C/H

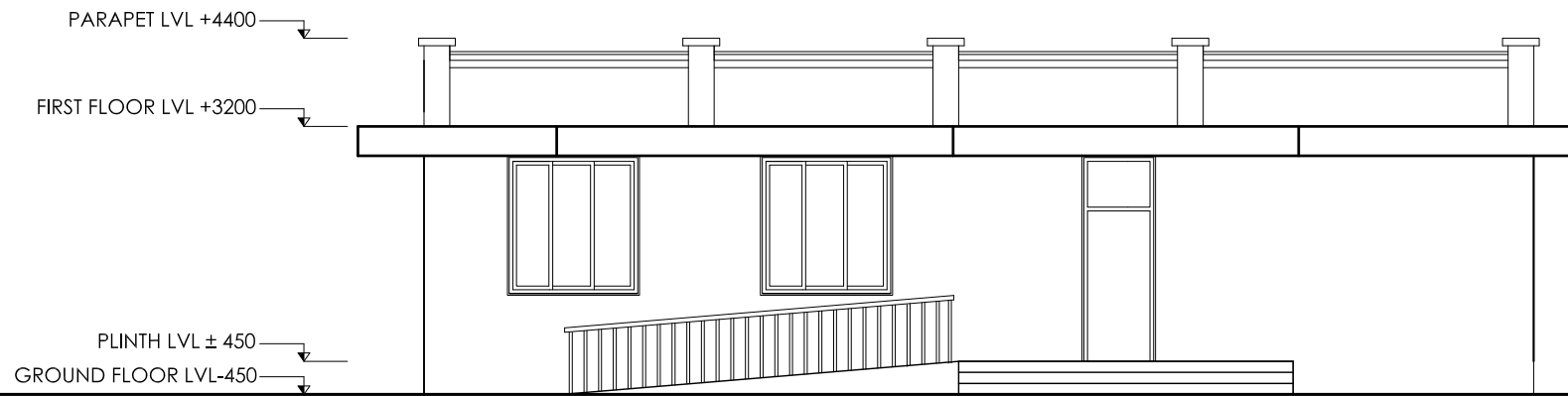

FRONT ELEVATION

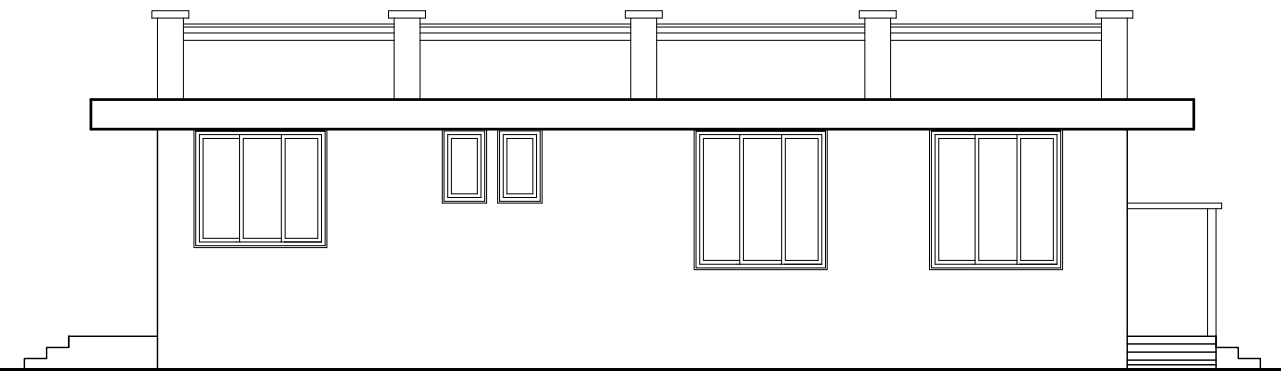

SIDE ELEVATION

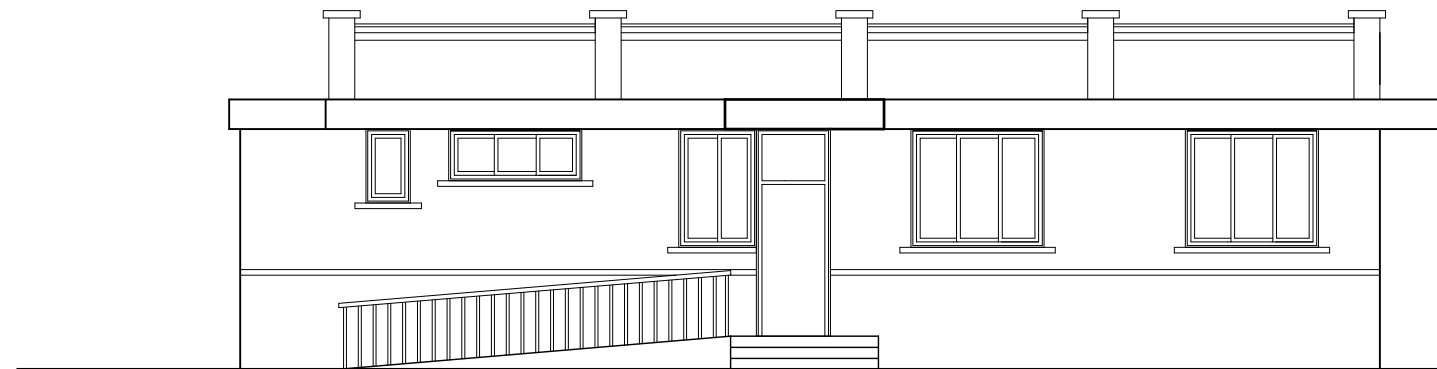

BACK ELEVATION

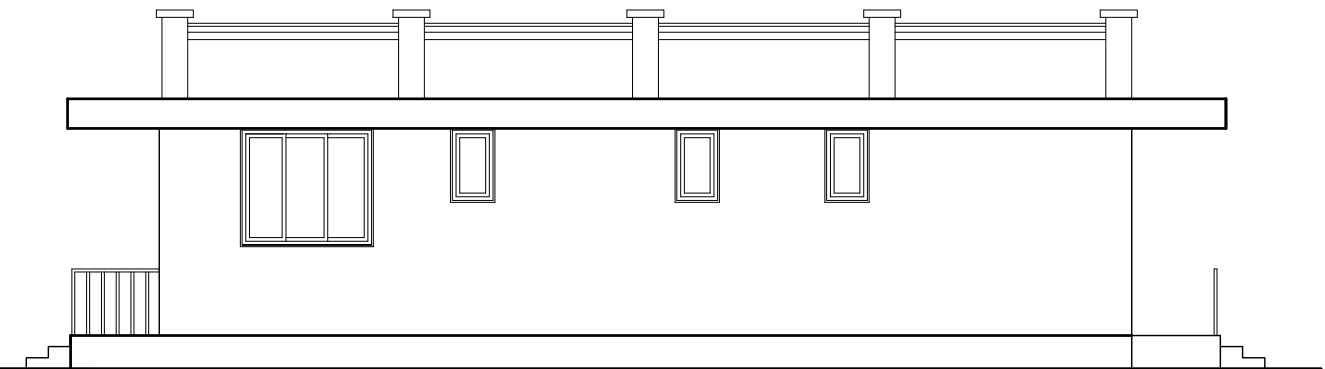

SIDE ELEVATION

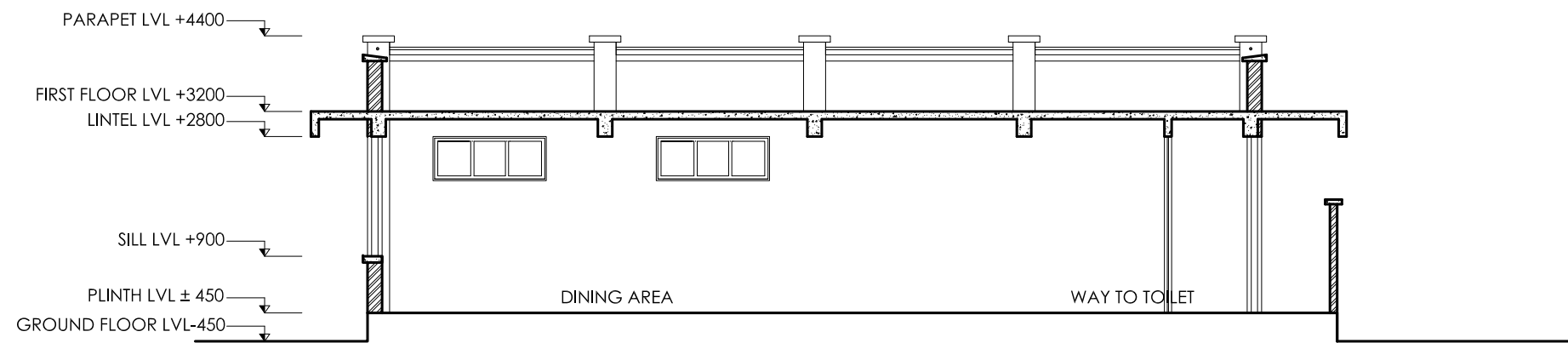

SECTION AT AA



**Management Division
Department of Health Service
Ministry of Health & Population**



**Health Building Infrastructure
Standard Design Drawings**

Job Name:

HOSPITAL CANTEEN
Brick / Single storied

Scale: 1:100

Date : 2070/6/7

Drawing title:
Elevation and section

Sheet no:

**AR/03
C/H**

OPENING TYPE	W1	W1A	V1	V1A	W2	V3
FLOOR LEVEL LINTEL LEVEL SHAPE AND SIZE FLOOR FINISH LEVEL STRUCTURE LEVEL						
QUANTITY	4	4	1	2	1	5
SPECIFICATION	SLIDING	SLIDING	SLIDING	FIXED	SLIDING	MOVABLE
LOCATION	GROUND FLOOR	GROUND FLOOR	GROUND FLOOR	GROUND FLOOR	GROUND FLOOR	GROUND FLOOR

OPENING TYPE	D1	D1A	D2	D2A	DW
FLOOR LEVEL LINTEL LEVEL SHAPE AND SIZE FLOOR FINISH LEVEL STRUCTURE LEVEL					
QUANTITY	6	1	2	3	1
SPECIFICATION	flush door	DOUBLE SWING	flush door	flush door	flush door and sliding window
LOCATION		DISABLED TOILET			



Management Division
 Department of Health Service
 Ministry of Health & Population



Health Building Infrastructure
 Standard Design Drawings

Job Name:

HOSPITAL CANTEEN
 Brick / Single storied

Scale: 1:100

Date : 2070/6/7

Drawing title:
 Opening
 Schedule

Sheet no:

AR/04
 C/H

SINGLE UNIT DOCTOR'S QUARTER

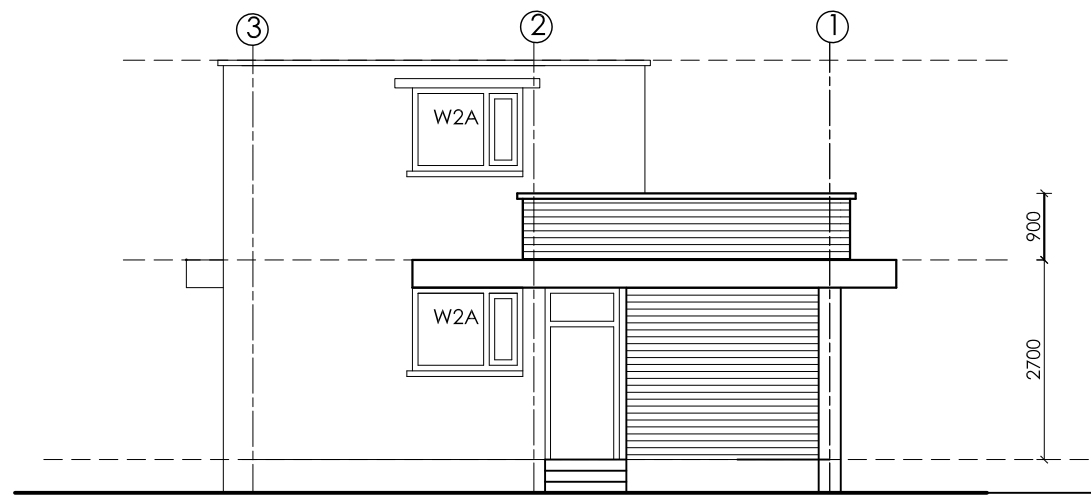

FRONT ELEVATION

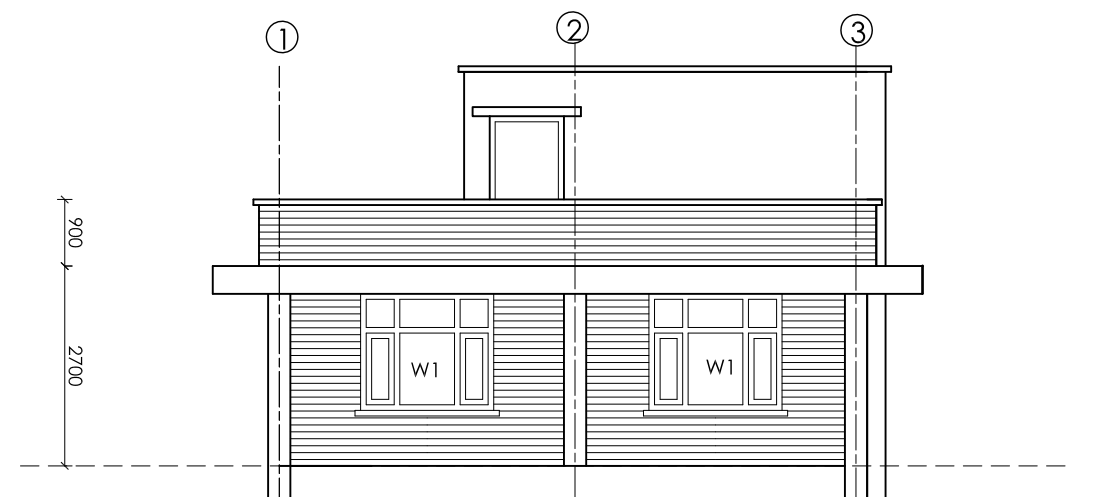

REAR ELEVATION

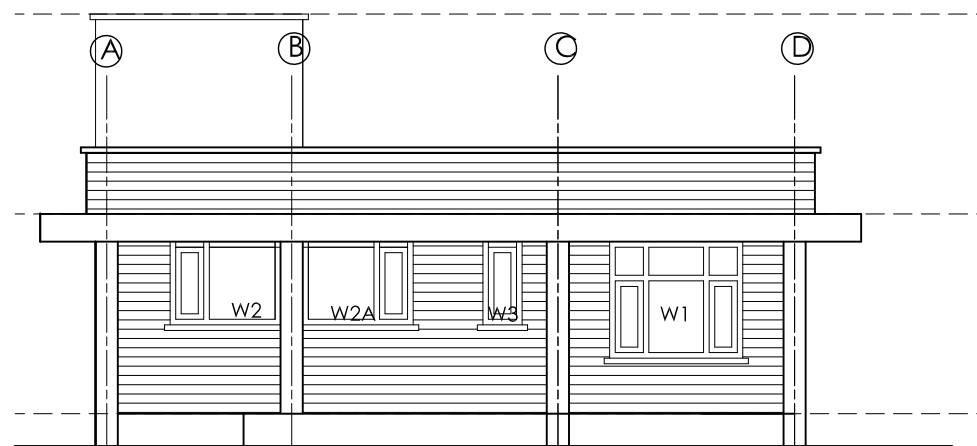

SIDE ELEVATION

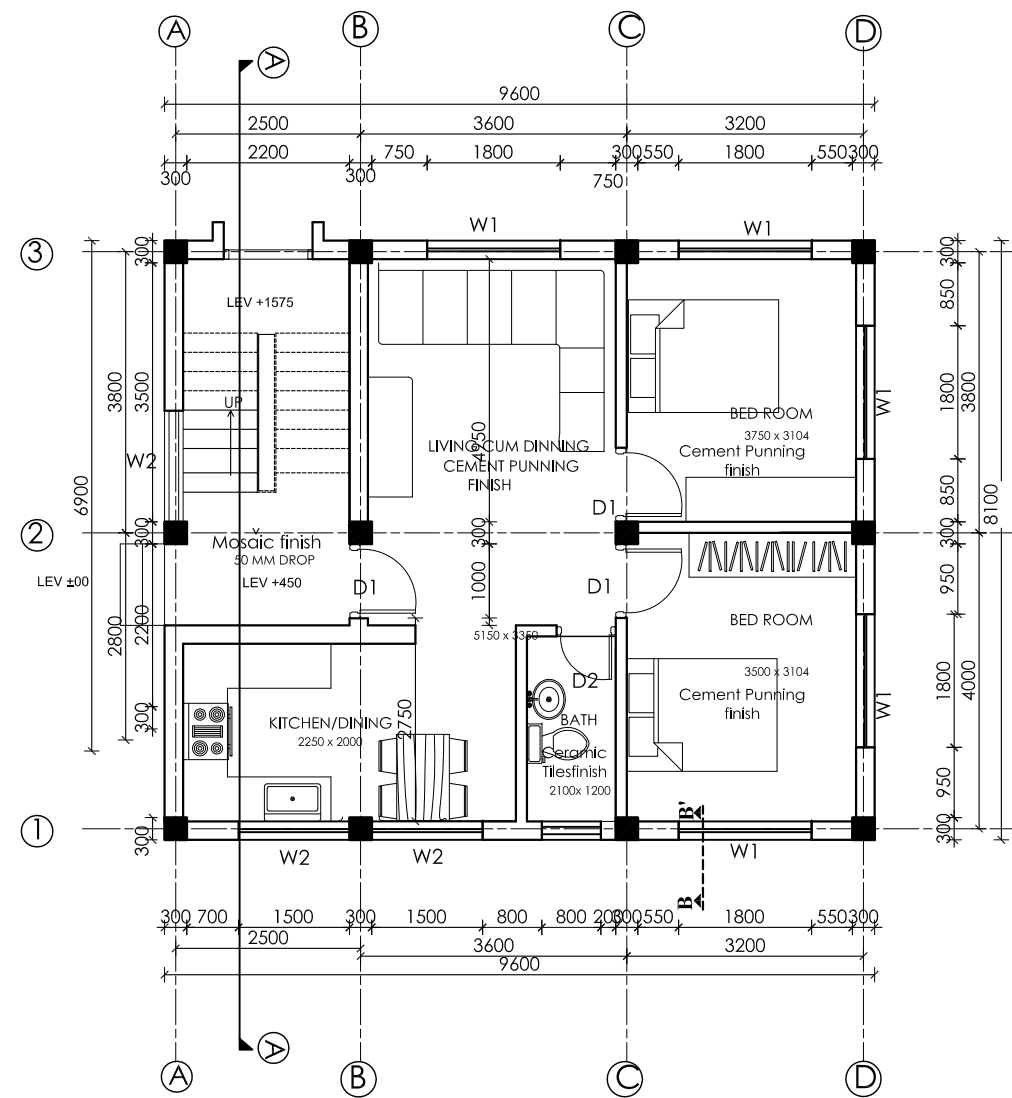

GROUND FLOOR PLAN

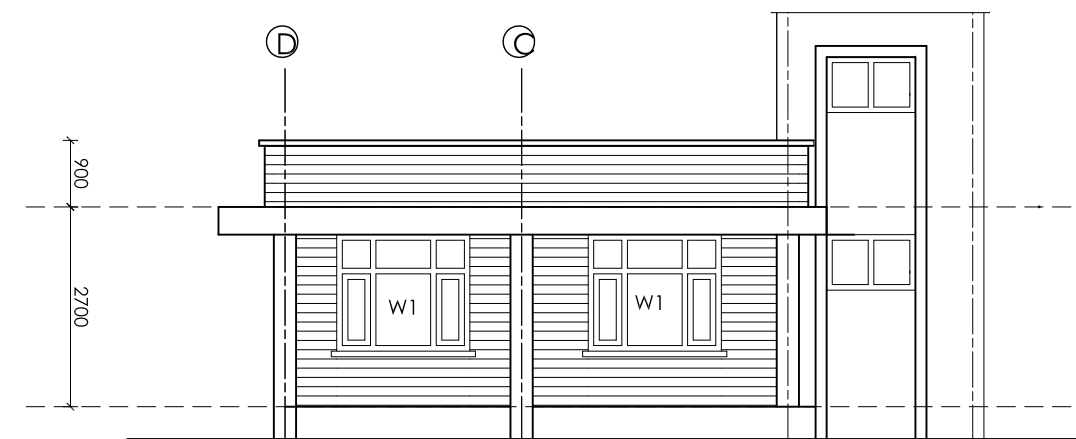

SIDE ELEVATION



Management Division
Department of Health Service
Ministry of Health & Population



Health Building Infrastructure
Standard Design Drawings

Job Name:
Single Unit Doctor's Quarter
Framed structure, 1-storey

Scale: 1:100

Date: 2070/6/7

Drawing title:
Plan and
Elevation

Sheet no:

AR/01
1D/Q

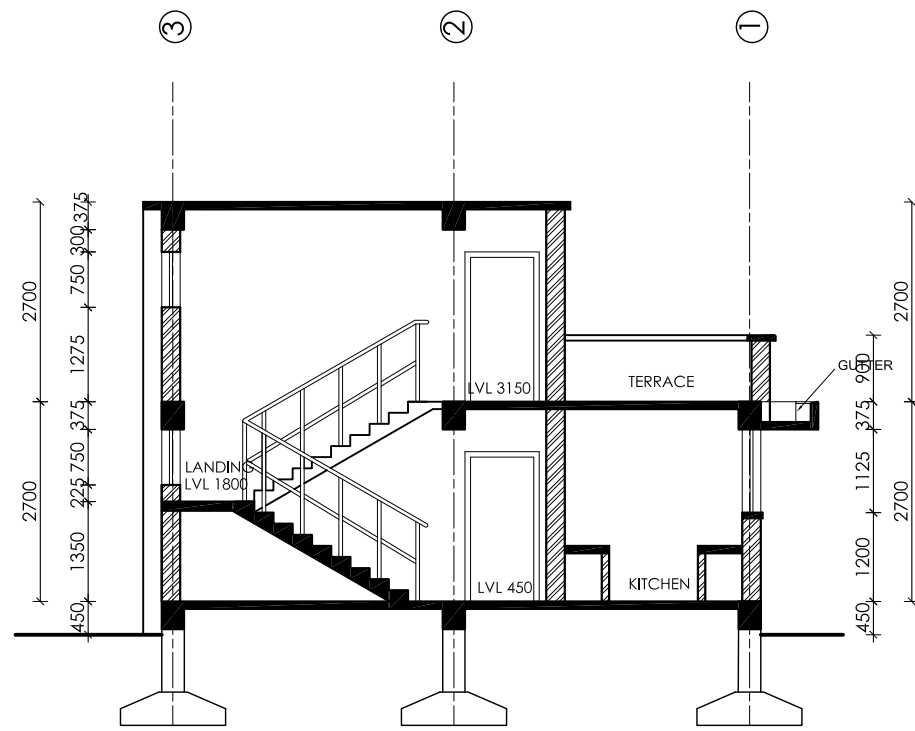

SECTION AT A-A

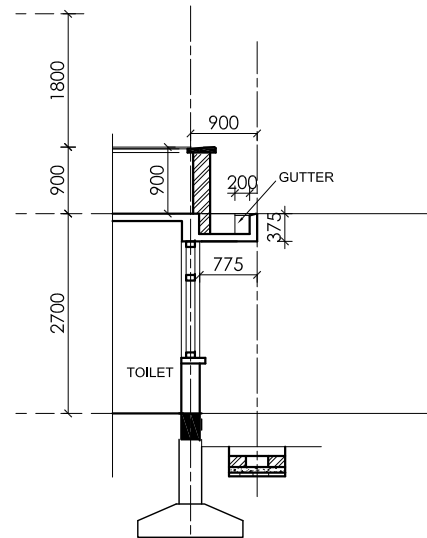

SECTION AT BB'

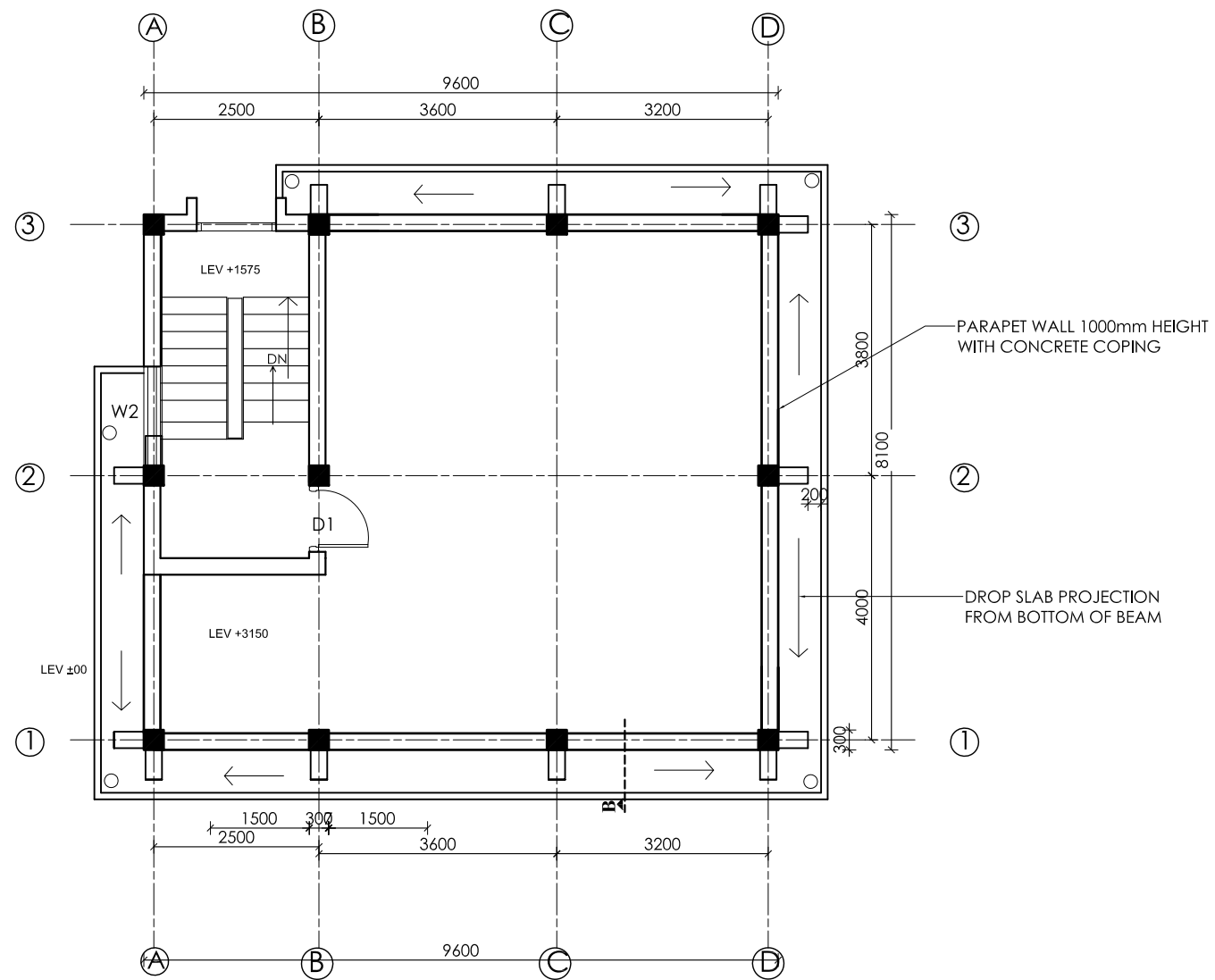

ROOF PLAN

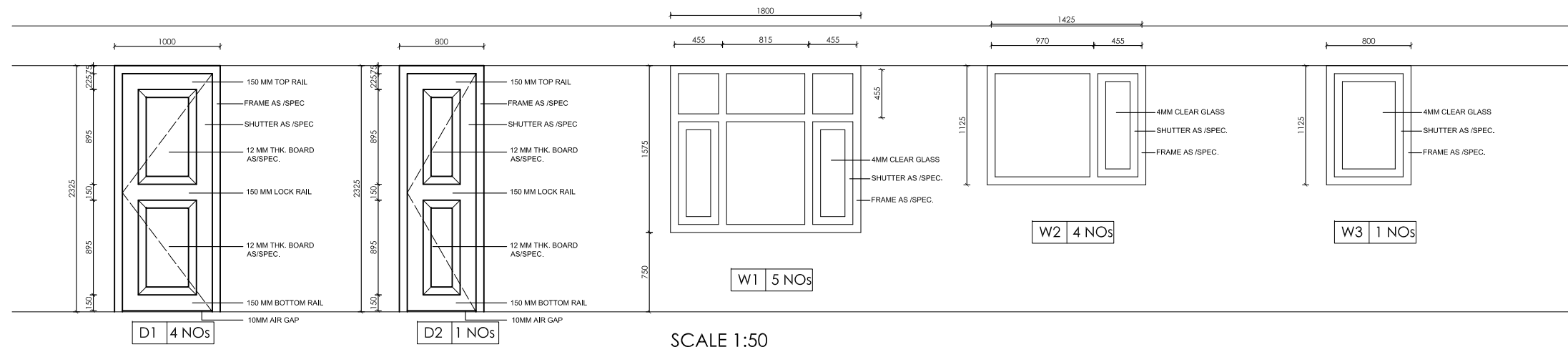

SCALE 1:50

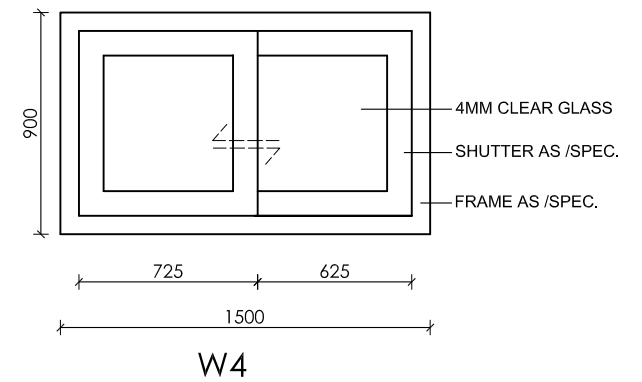
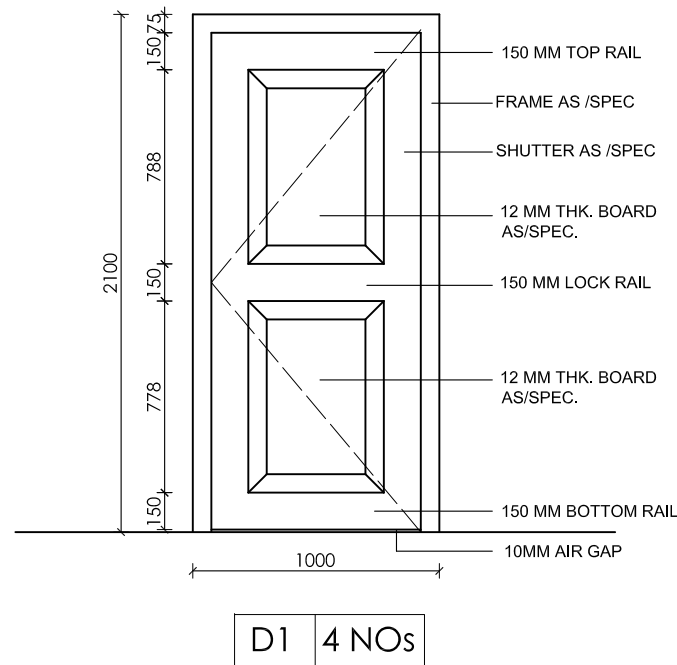
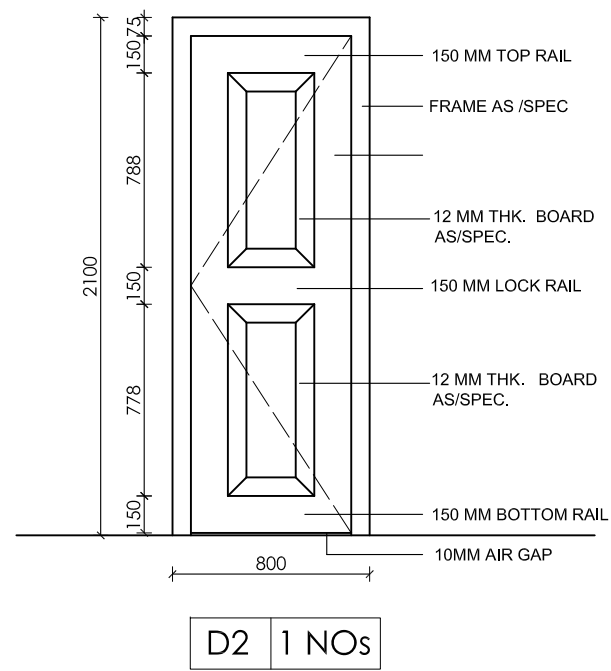
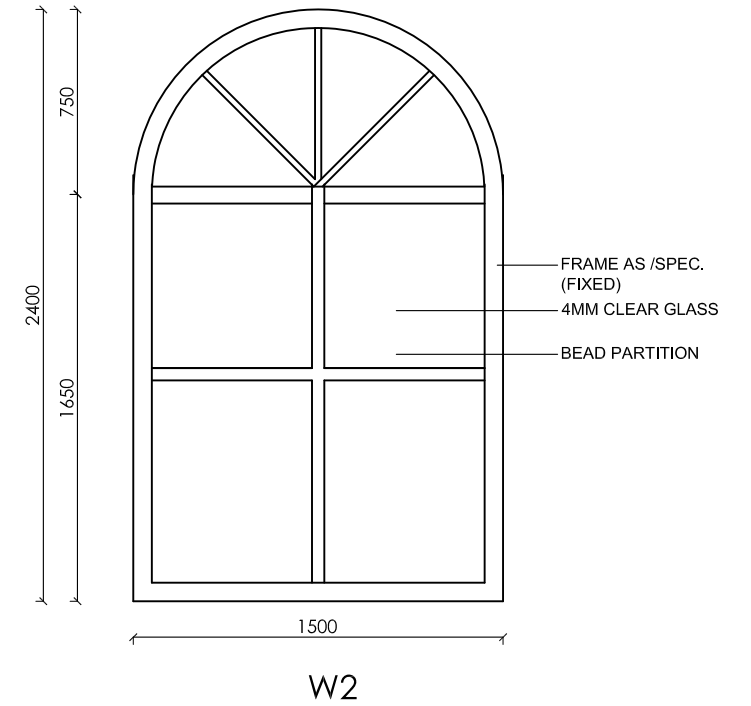
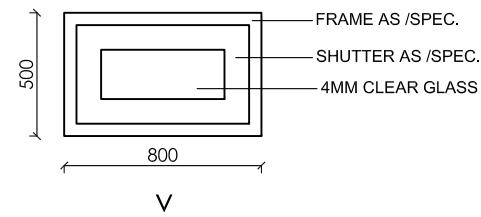
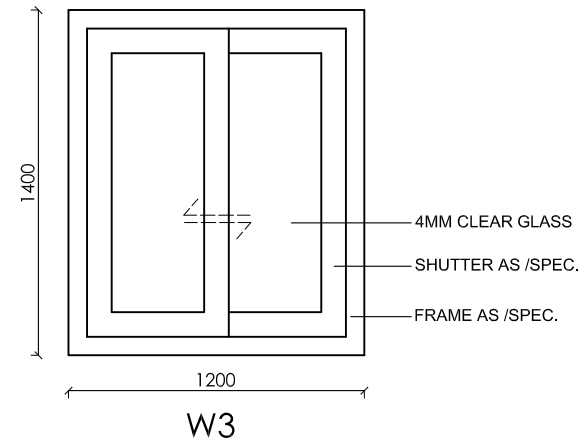
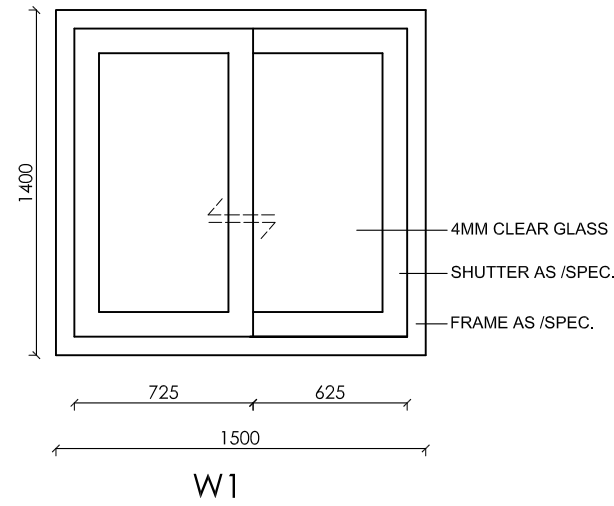

Management Division
Department of Health Service
Ministry of Health & Population



Health Building Infrastructure
Standard Design Drawings

Job Name:
Single Unit Doctor's Quarter
Framed structure, 1-storey

Scale: 1:100

Date : 2070/6/7

Drawing title:
Opening Detail

Sheet no:

AR/03
1D/Q

**STAFF QUARTER
TWO UNIT**

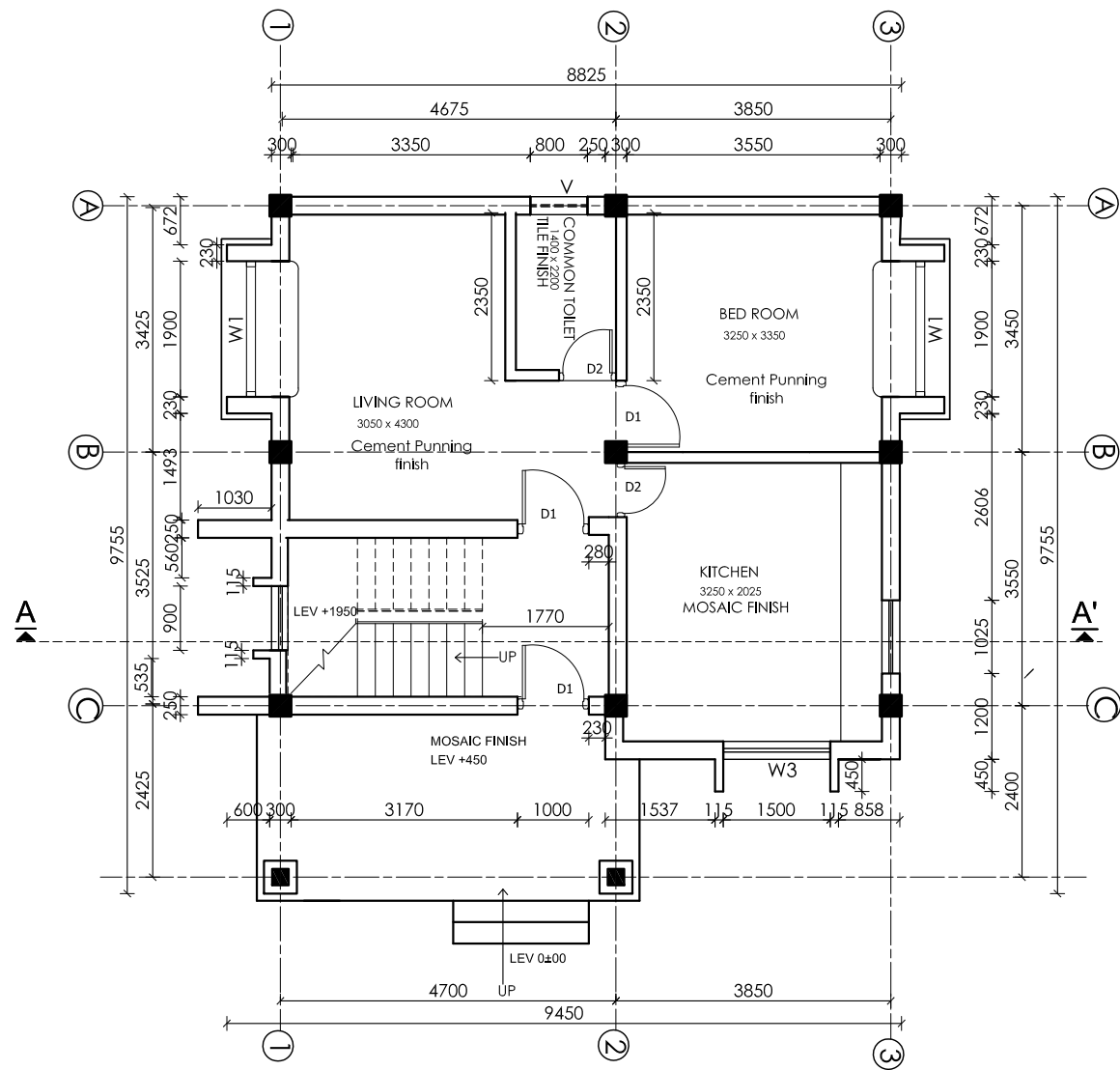

GROUND FLOOR PLAN

AREA:82.88 sq.m.

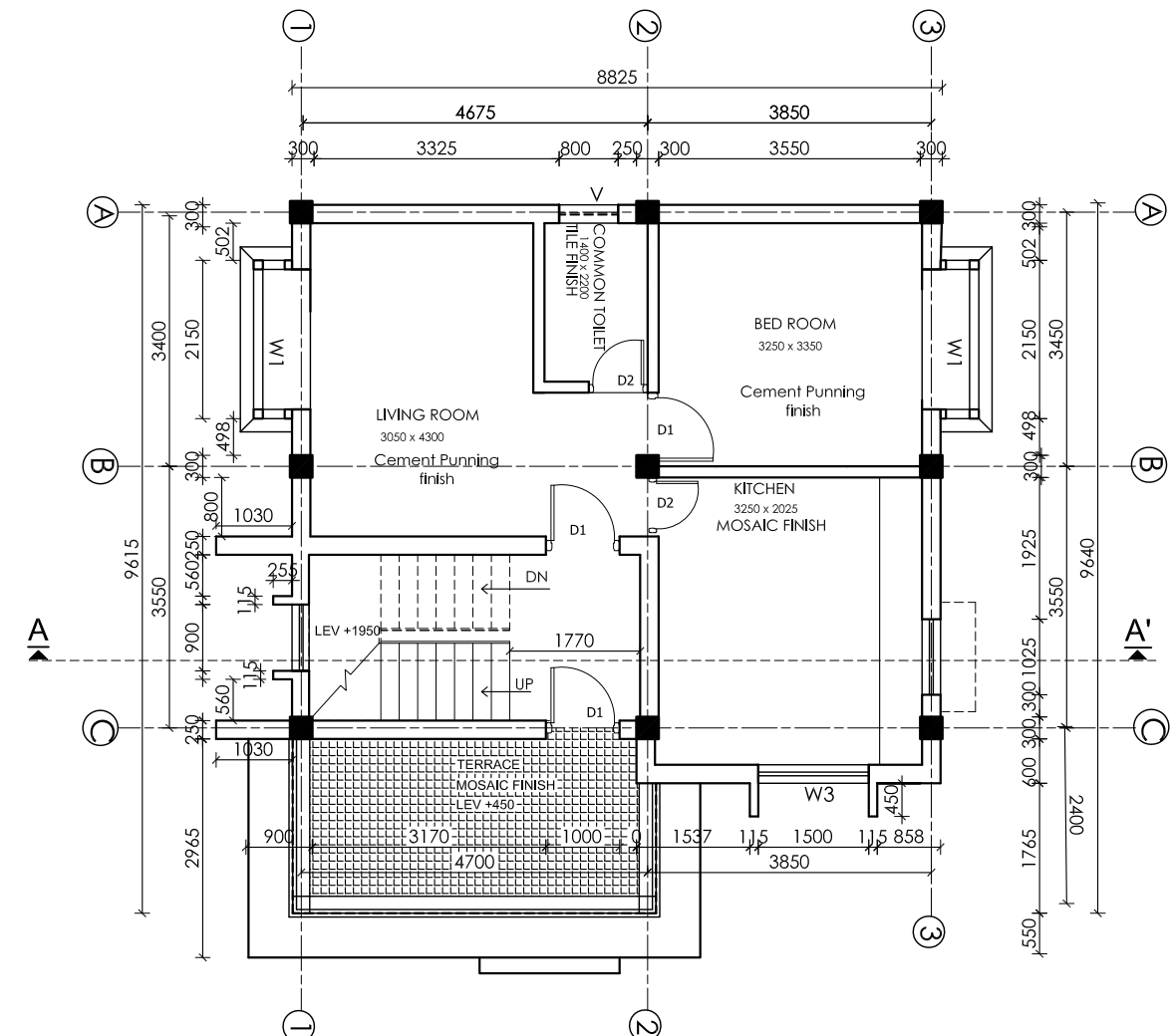
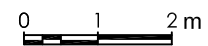

FIRST FLOOR PLAN

AREA:81.63 sq.m.



**Management Division
Department of Health Service
Ministry of Health & Population**



**Health Building Infrastructure
Standard Design Drawings**

Job Name:
Two Unit Staff Quarter
Brick, 1-storey

Scale: 1:100

Date: 2070/6/7

Drawing title:
Plans

Sheet no:
AR/01
2S/Q/B



Front elevation

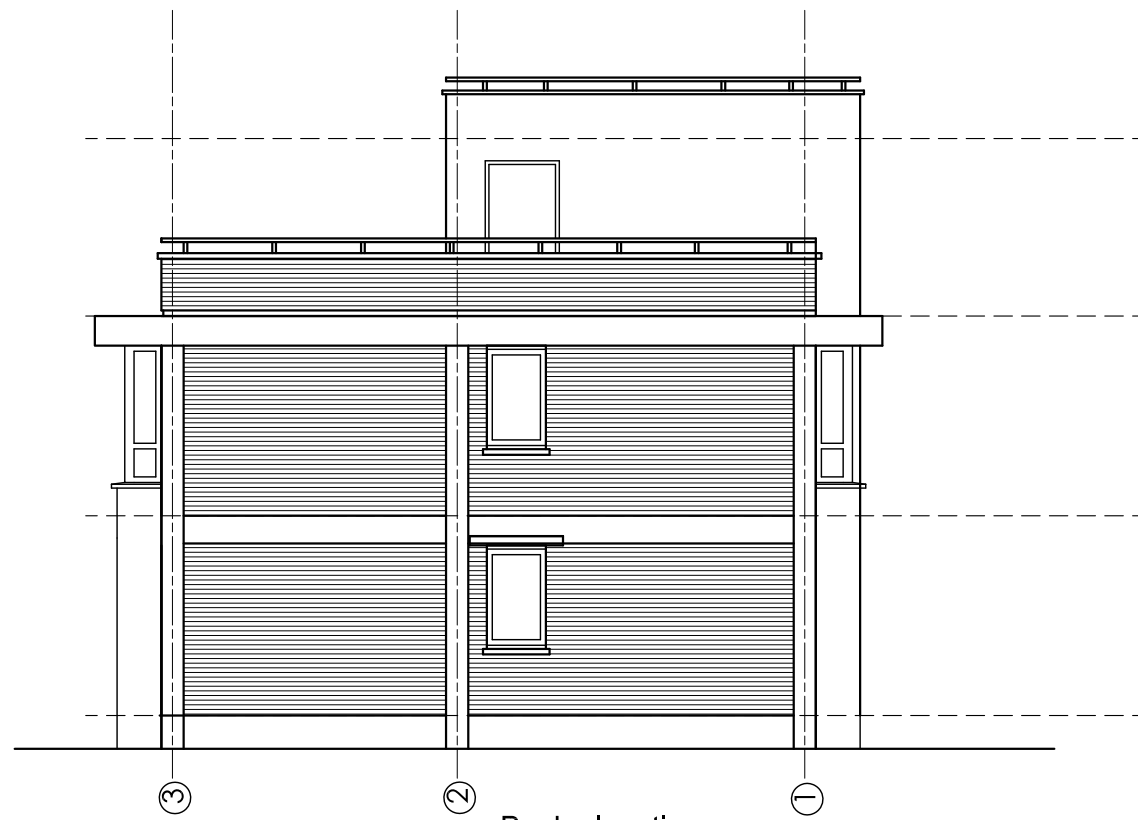

Back elevation



Side elevation

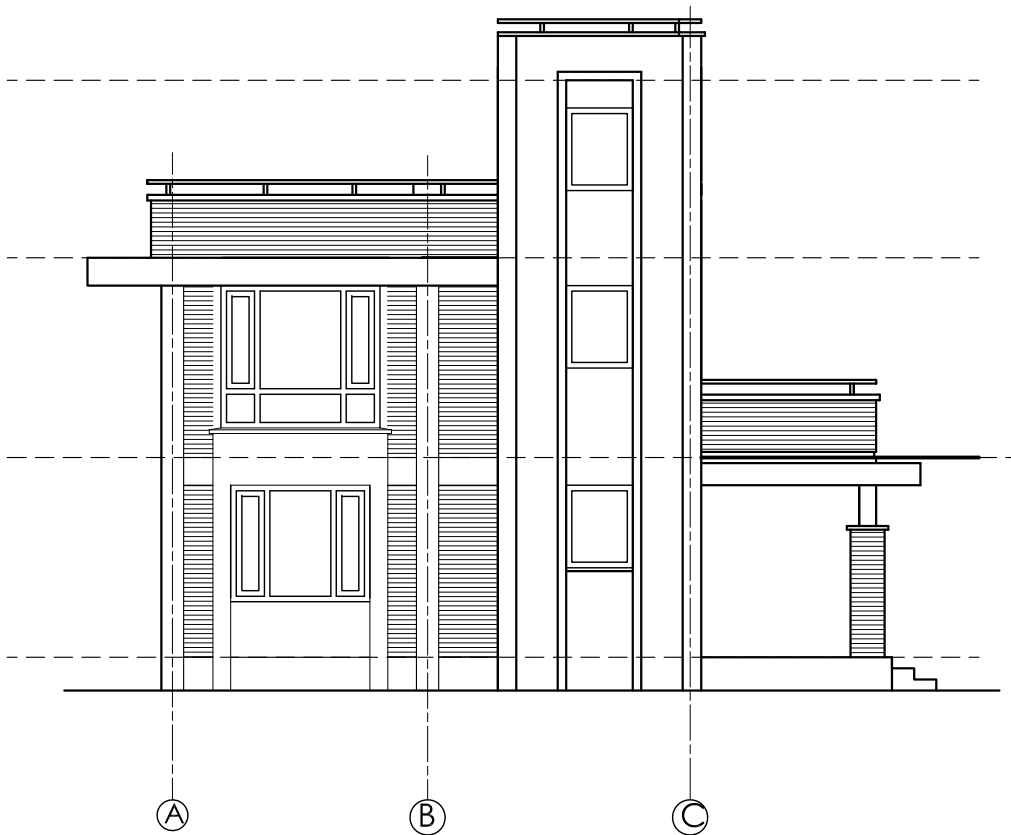

Side elevation



Management Division
Department of Health Service
Ministry of Health & Population



Health Building Infrastructure
Standard Design Drawings

Job Name:
Two Unit Staff Quarter
Brick, 1-storey
Scale: 1:100
Date: 2070/6/7

Drawing title:
Elevations

Sheet no:

AR/02
2S/Q/B

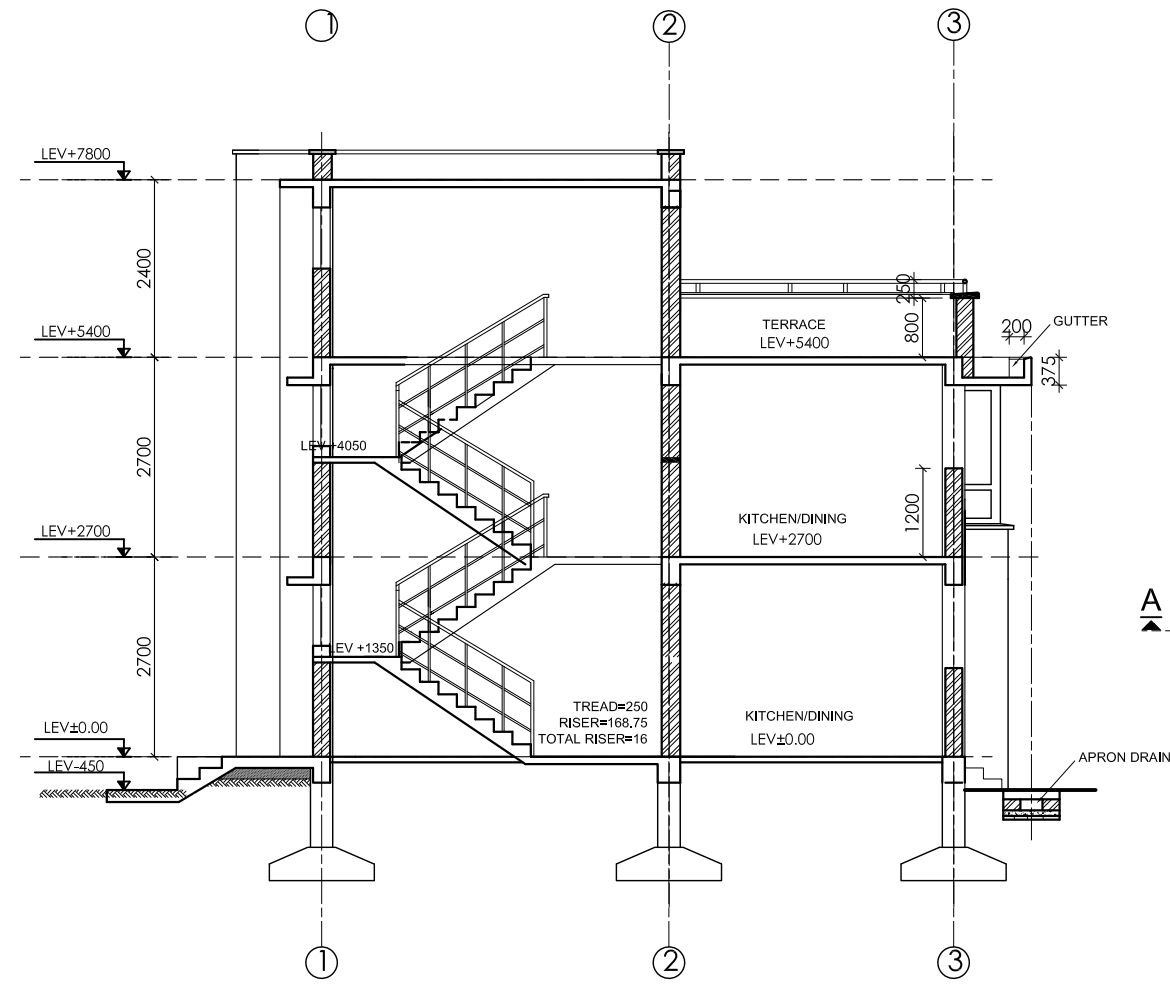
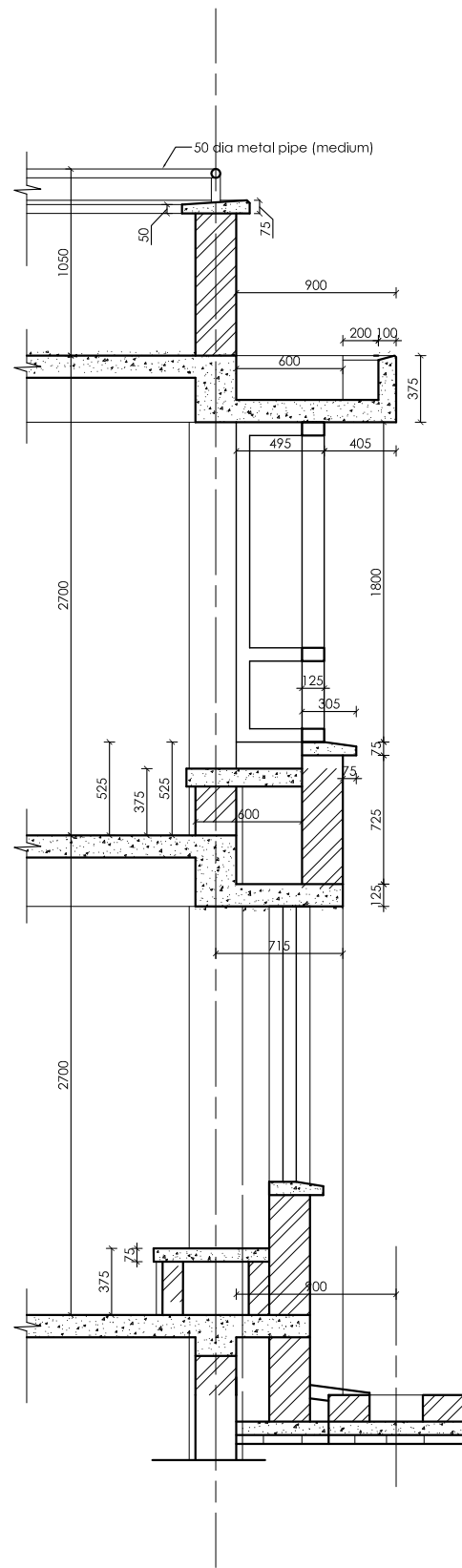

SECTION AT A-A'

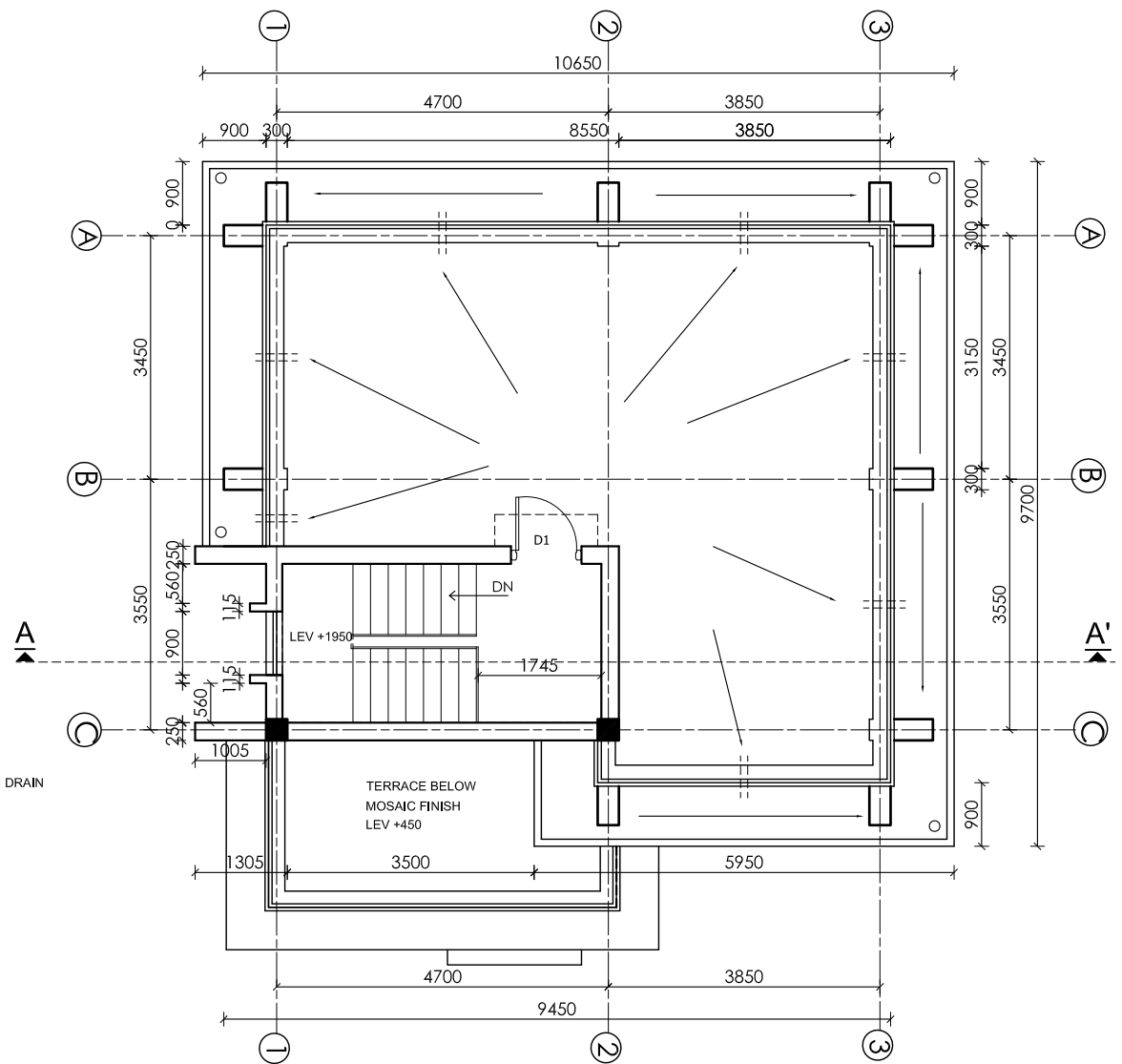

ROOF PLAN

AREA:104.55 sq.m.



Management Division
Department of Health Service
Ministry of Health & Population



Health Building Infrastructure
Standard Design Drawings

Job Name:
Two Unit Staff Quarter
Brick, 1-storey

Scale: 1:100

Date: 2070/6/7

Drawing title:
Plan and
Sections

Sheet no:

AR/03
2S/Q/B

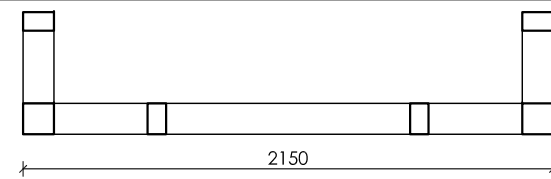

PLAN OF THE BAY WINDOW

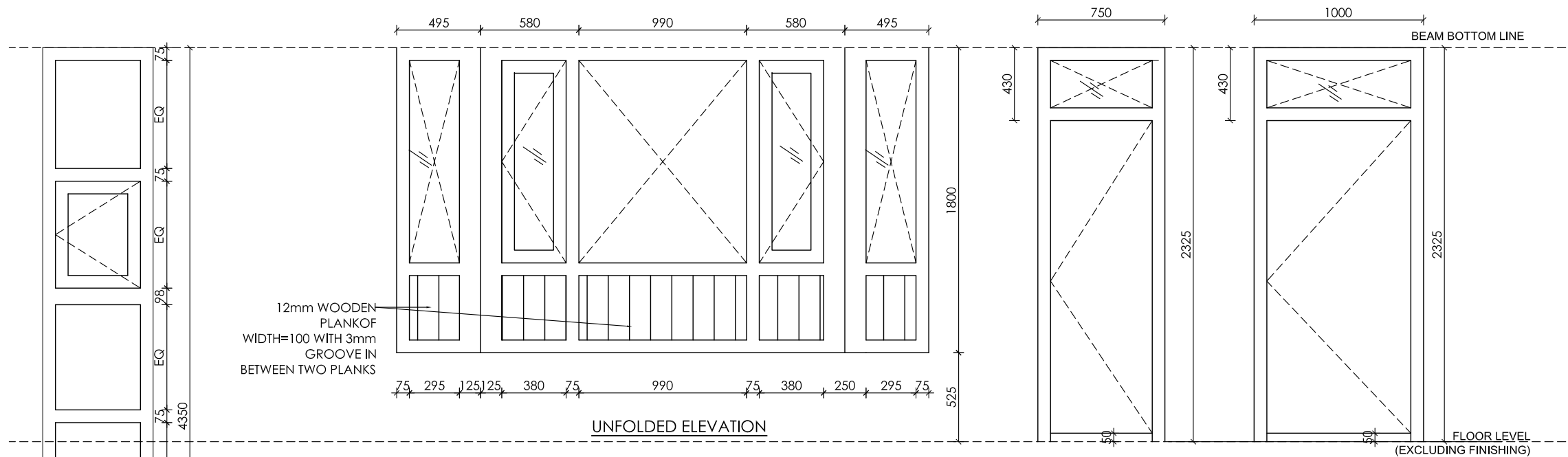

UNFOLDED ELEVATION

4nos W2

4nos D2

4nos D1

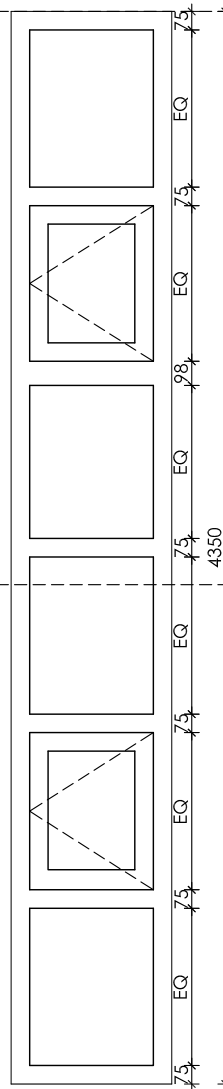

2nos W4

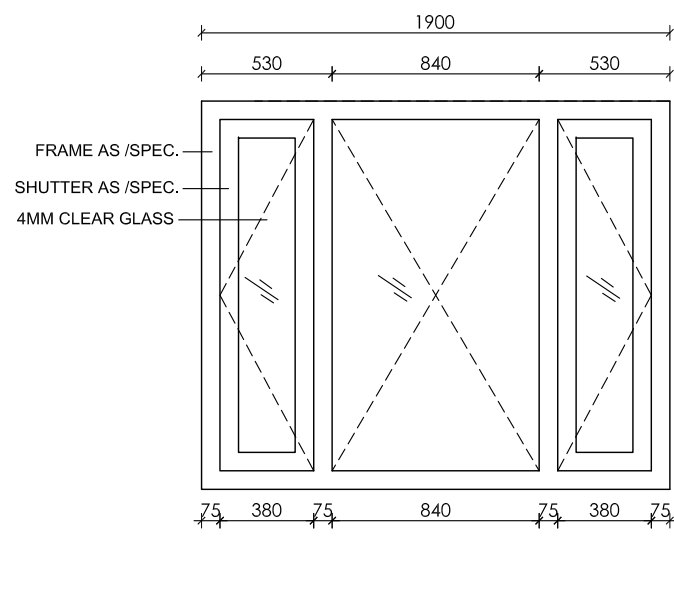

4nos W1

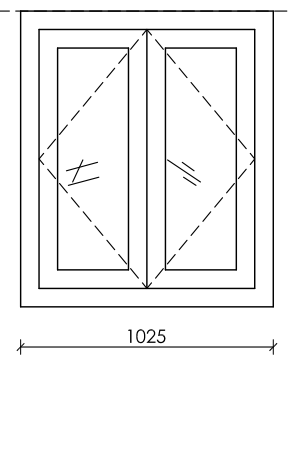

4nos W3

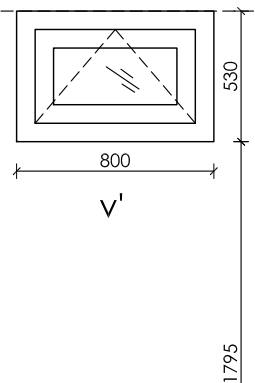

4nos V1

**STAFF QUARTER
FOUR UNIT**

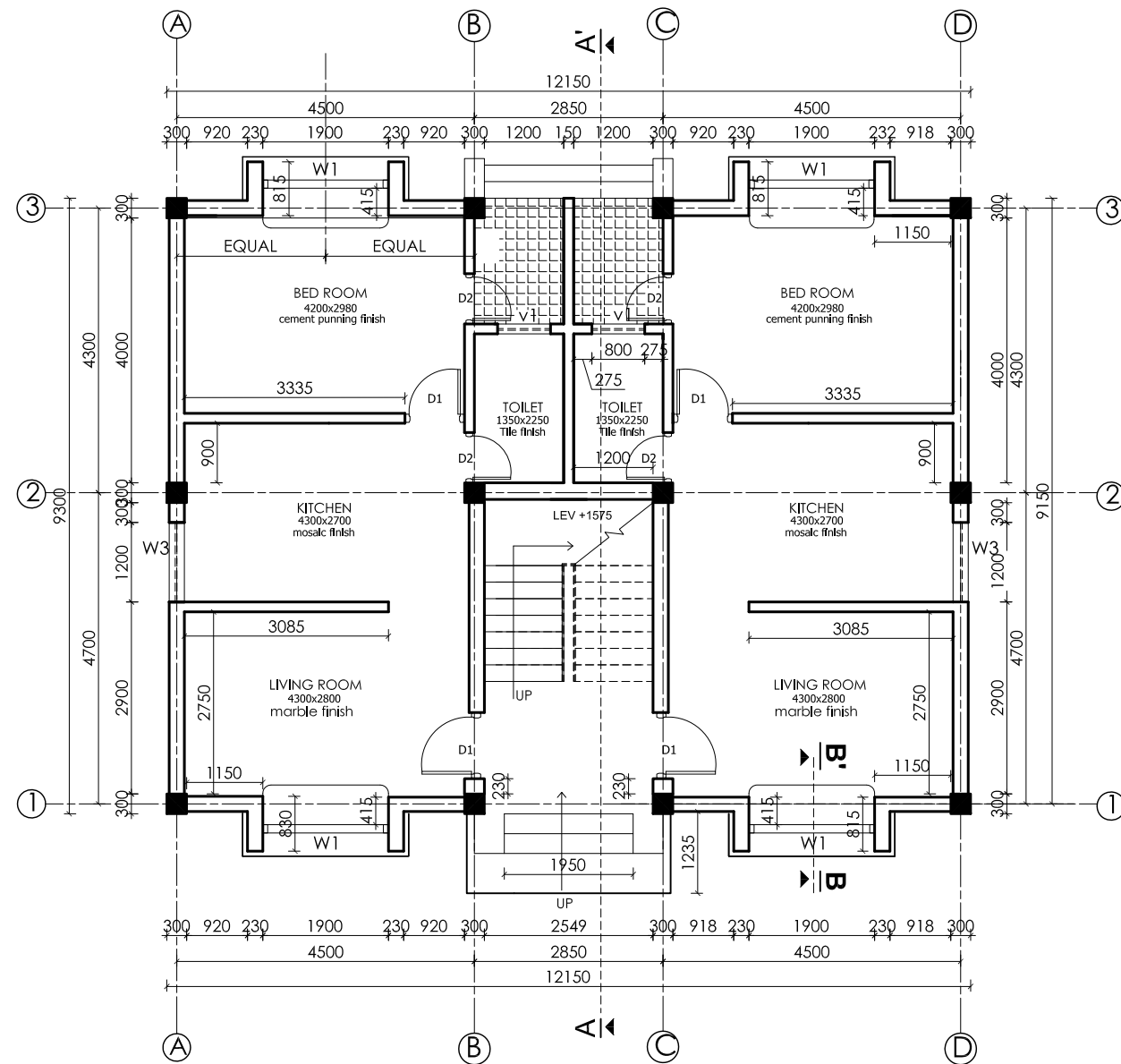

GROUND FLOOR PLAN

AREA:117.86 sq.m.

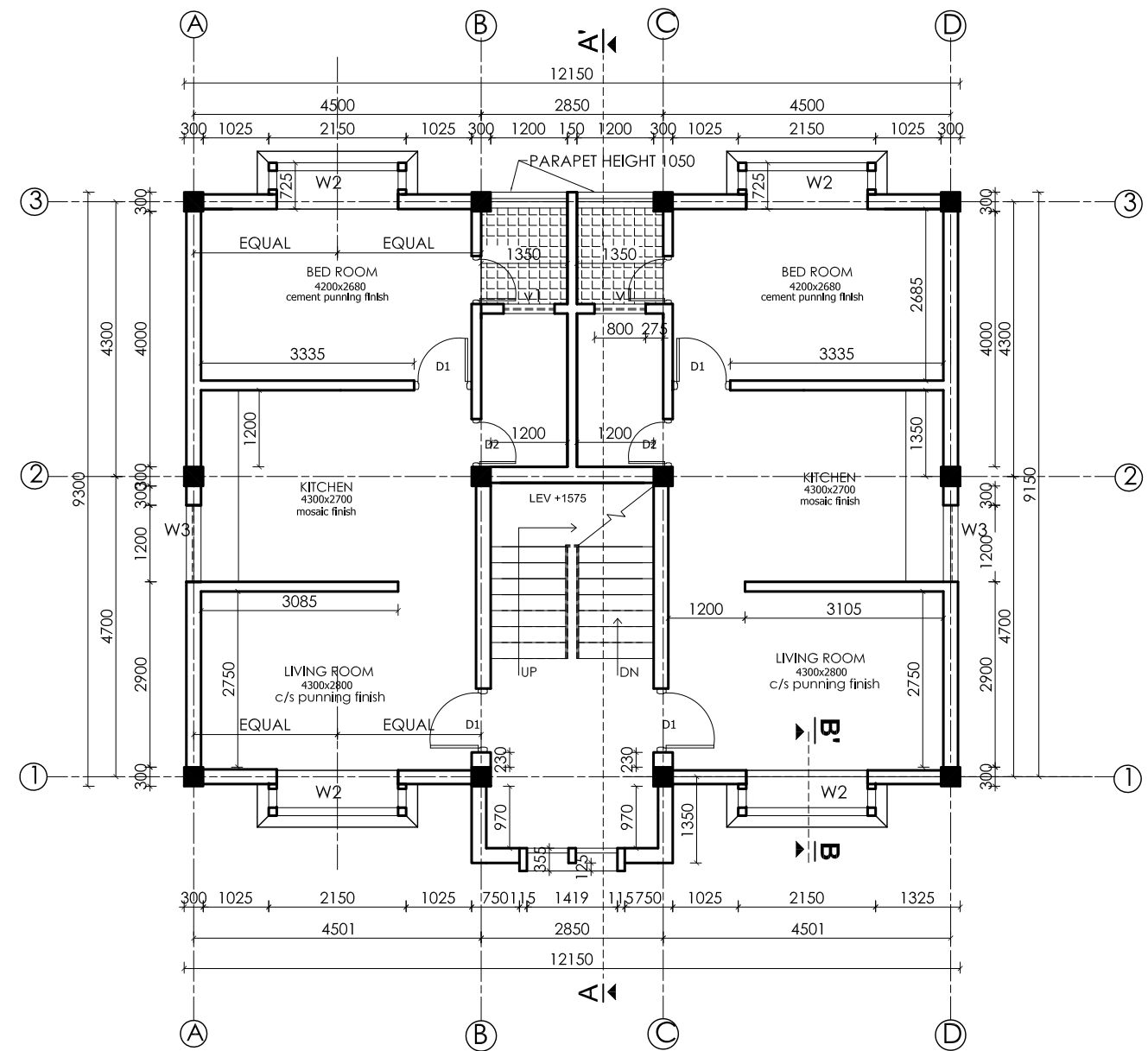

FIRST FLOOR PLAN

AREA:120.06 sq.m.

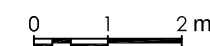

**Management Division
Department of Health Service
Ministry of Health & Population**



**Health Building Infrastructure
Standard Design Drawings**

Job Name:
Four Unit Staff Quarter
Framed structure, 2-storey

Scale: 1:100

Date: 2070/6/7

Drawing title:
Plans

Sheet no:

**AR/01
4S/Q**

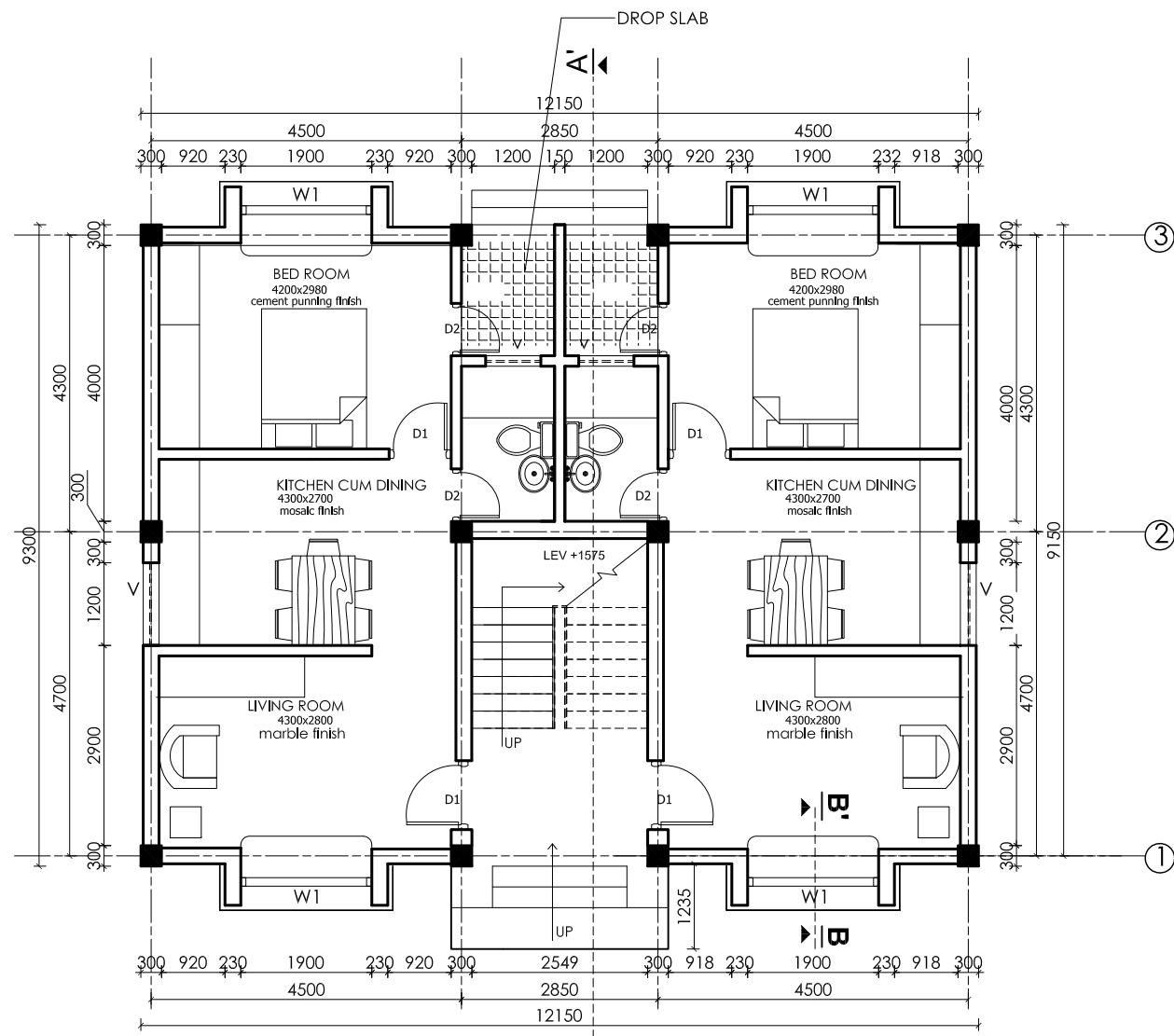

GROUND FLOOR PLAN

AREA:117.86 sq.m.

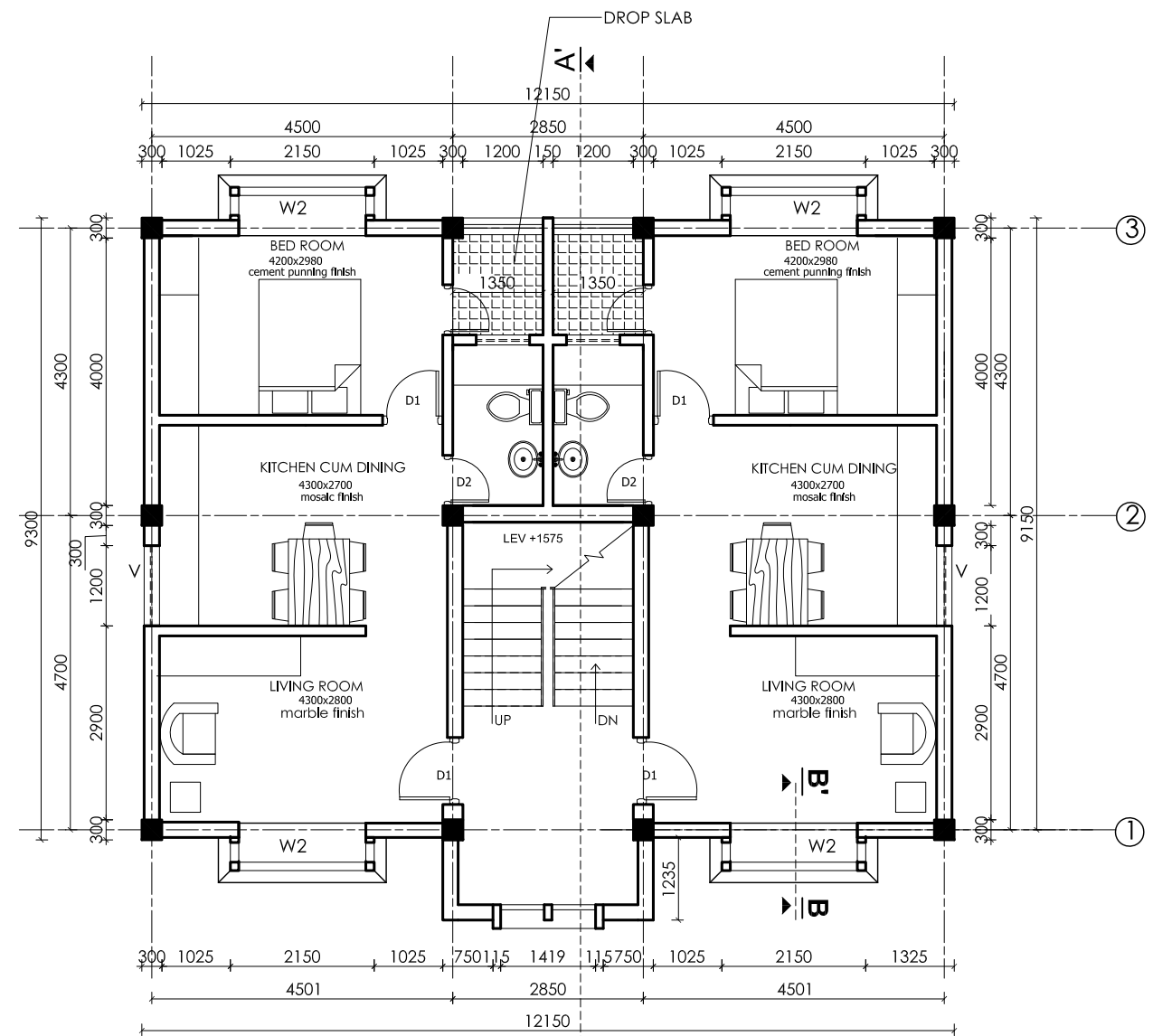
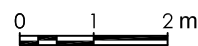

FIRST FLOOR PLAN

AREA:120.06 sq.m.



FURNITURE LAYOUT PLAN

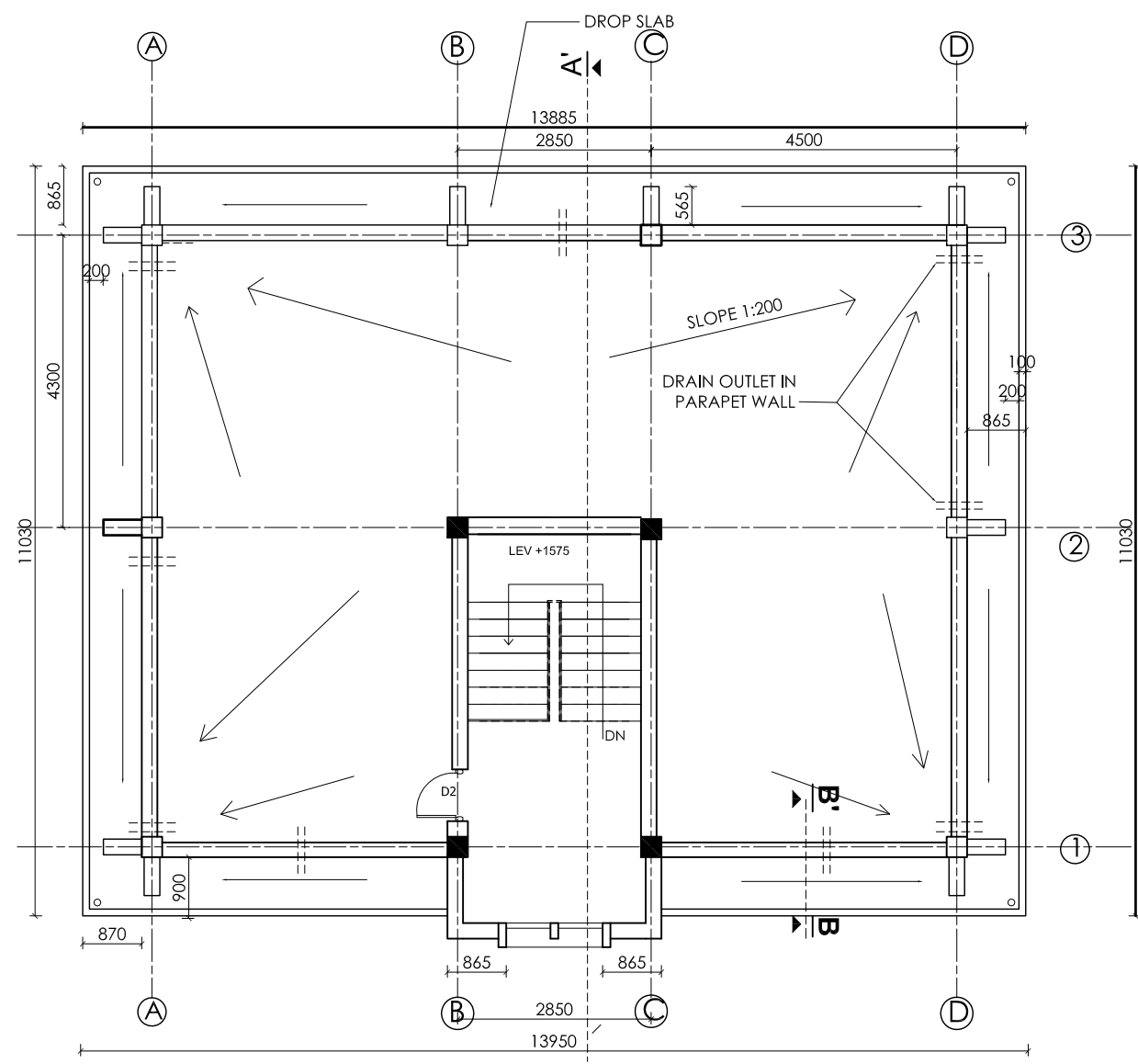

ROOF FLOOR PLAN

AREA:153.15 sq.m.

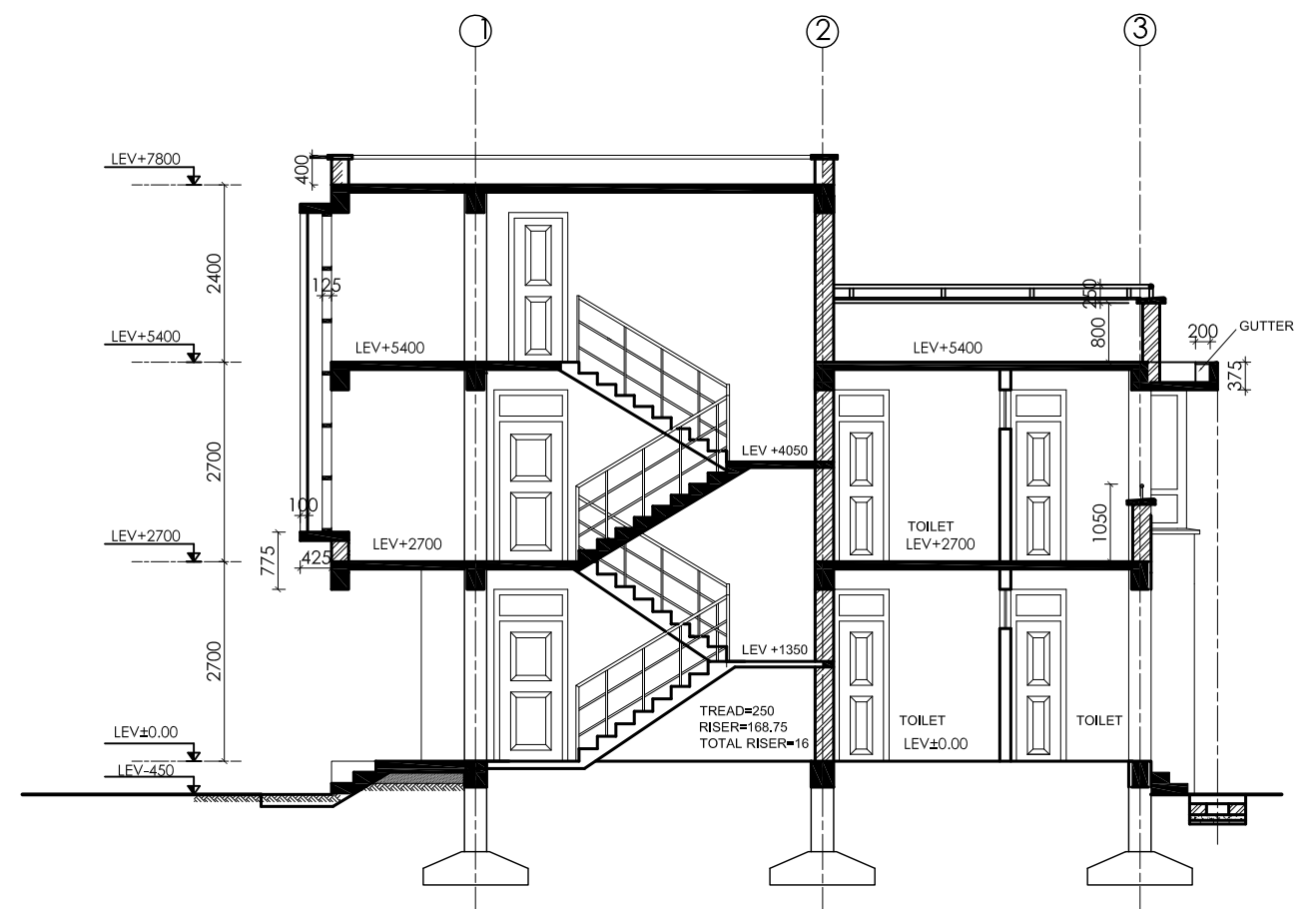
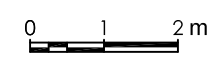

SECTION AT A-A'

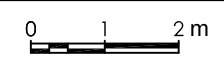

**Management Division
Department of Health Service
Ministry of Health & Population**



**Health Building Infrastructure
Standard Design Drawings**

Job Name:
Four Unit Staff Quarter
Framed structure, 2-storey

Scale: 1:100

Date: 2070/6/7

Drawing title:
Plan and
Section

Sheet no:

**AR/03
4S/Q**

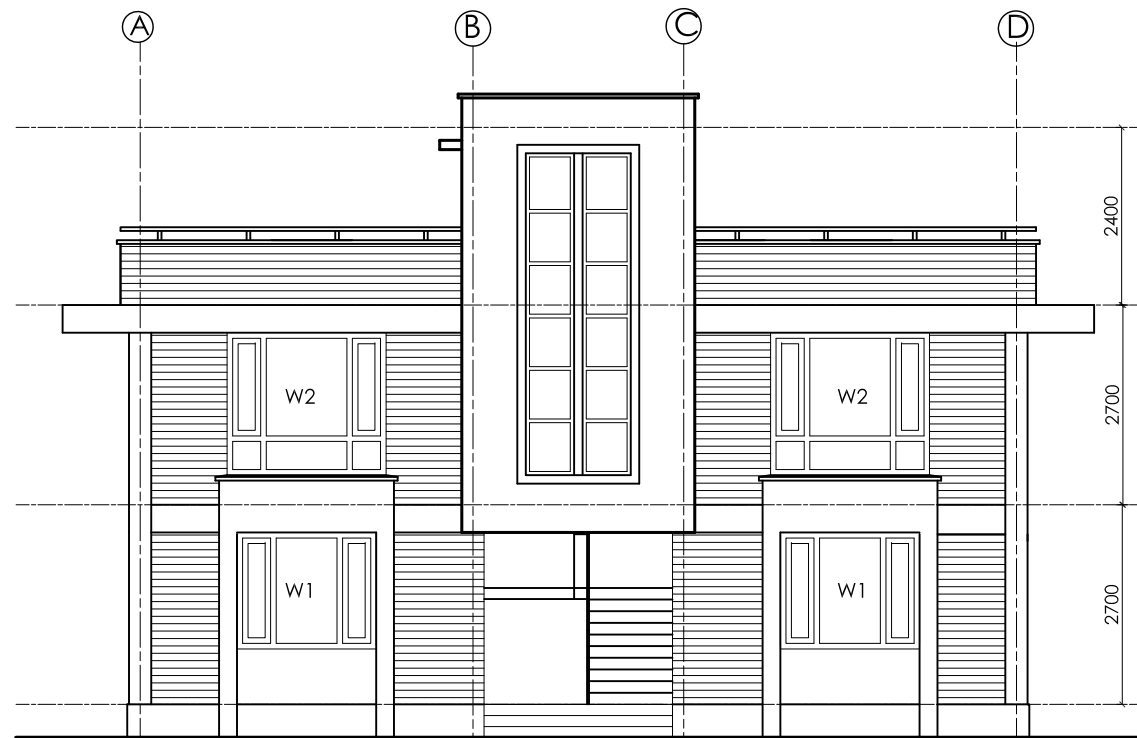

FRONT ELEVATION

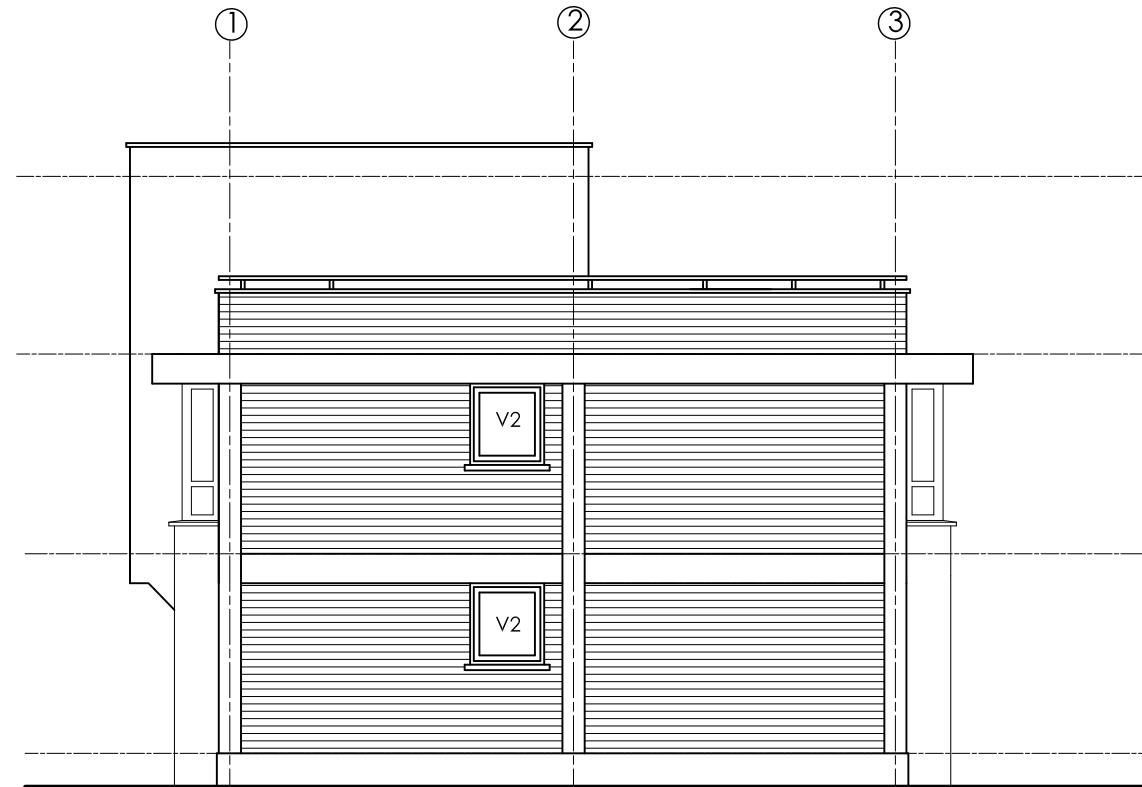
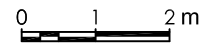

RIGHT SIDE ELEVATION

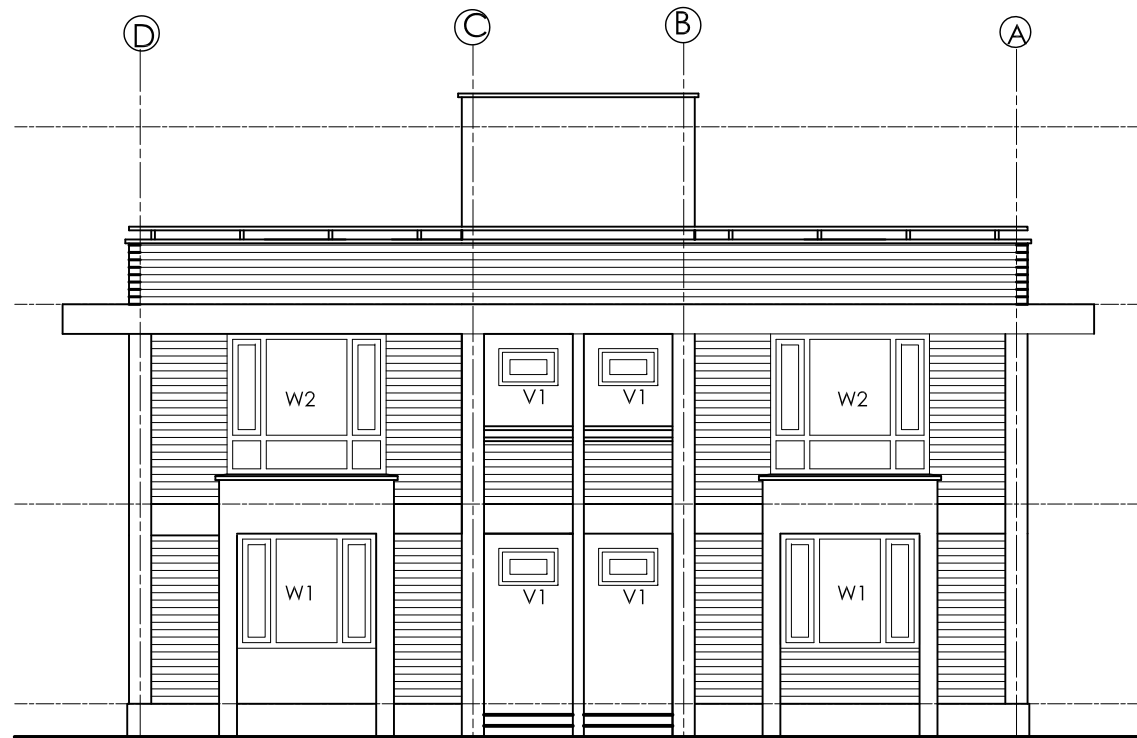
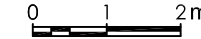

BACK ELEVATION

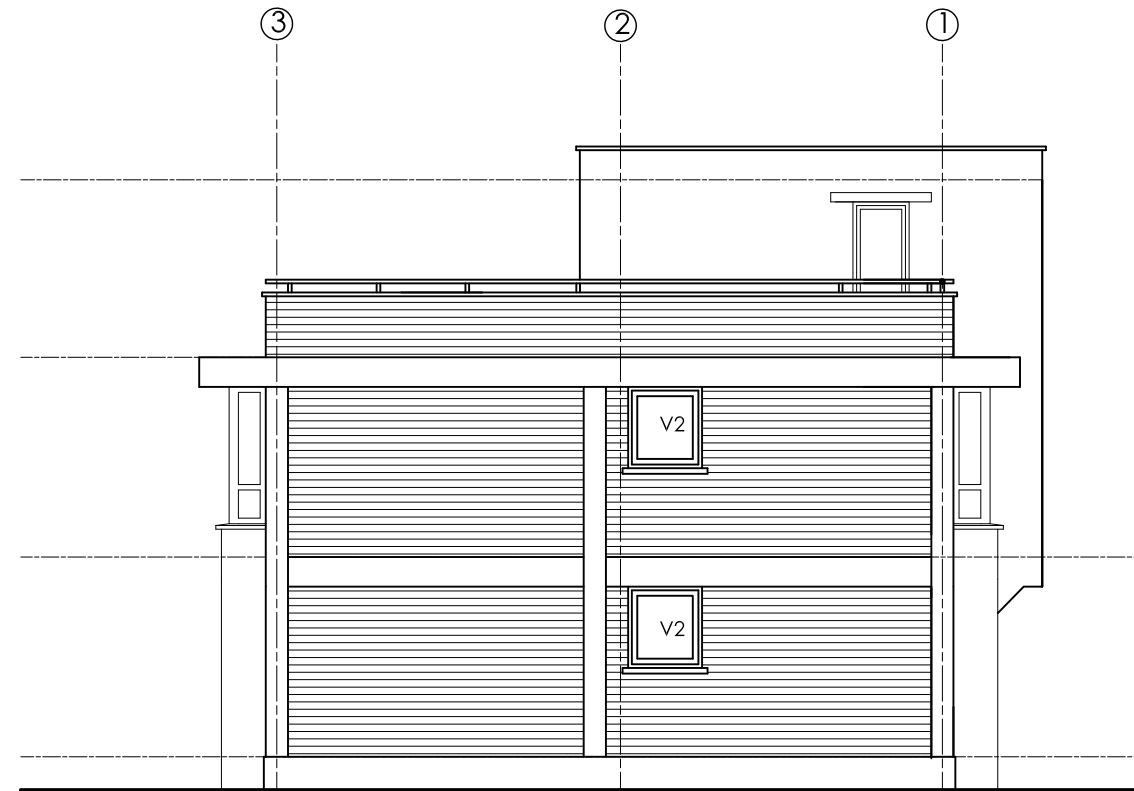
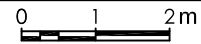

LEFT SIDE ELEVATION



Management Division
Department of Health Service
Ministry of Health & Population



Health Building Infrastructure
Standard Design Drawings

Job Name:
Four Unit Staff Quarter
Framed structure, 2-storey

Scale: 1:100

Date: 2070/6/7

Drawing title:
Elevations

Sheet no:

AR/04
4S/Q

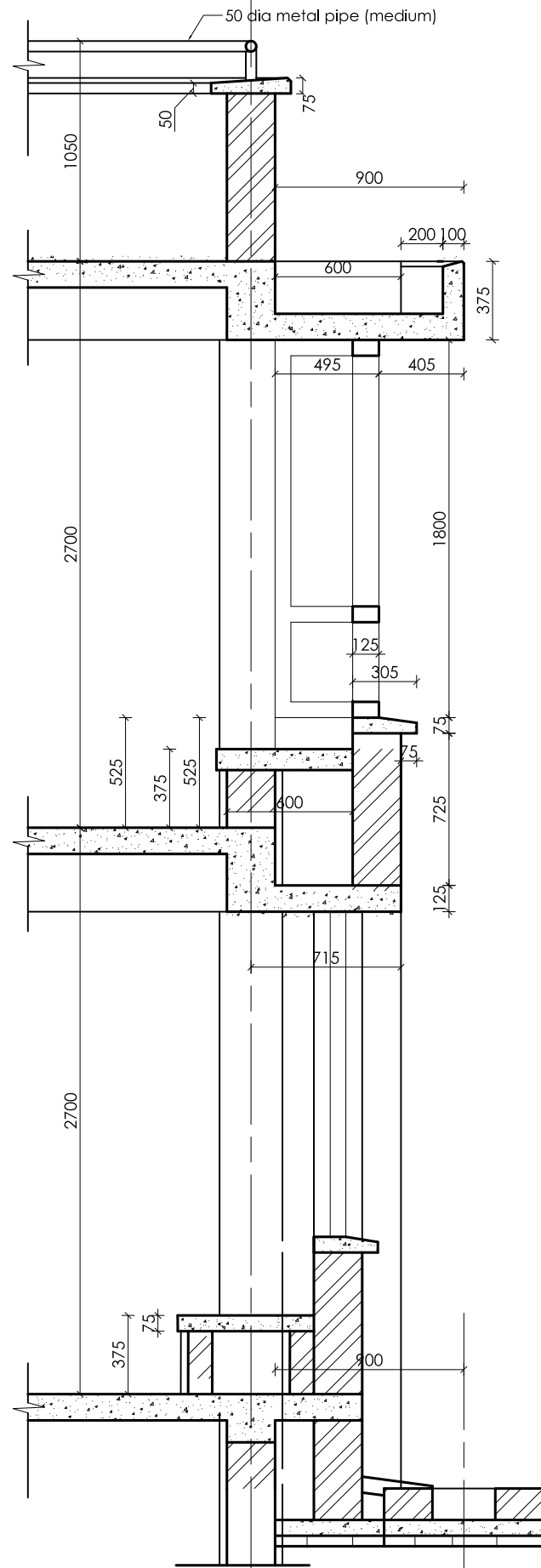

WALL SECTION AT 1
SCALE - 1:30

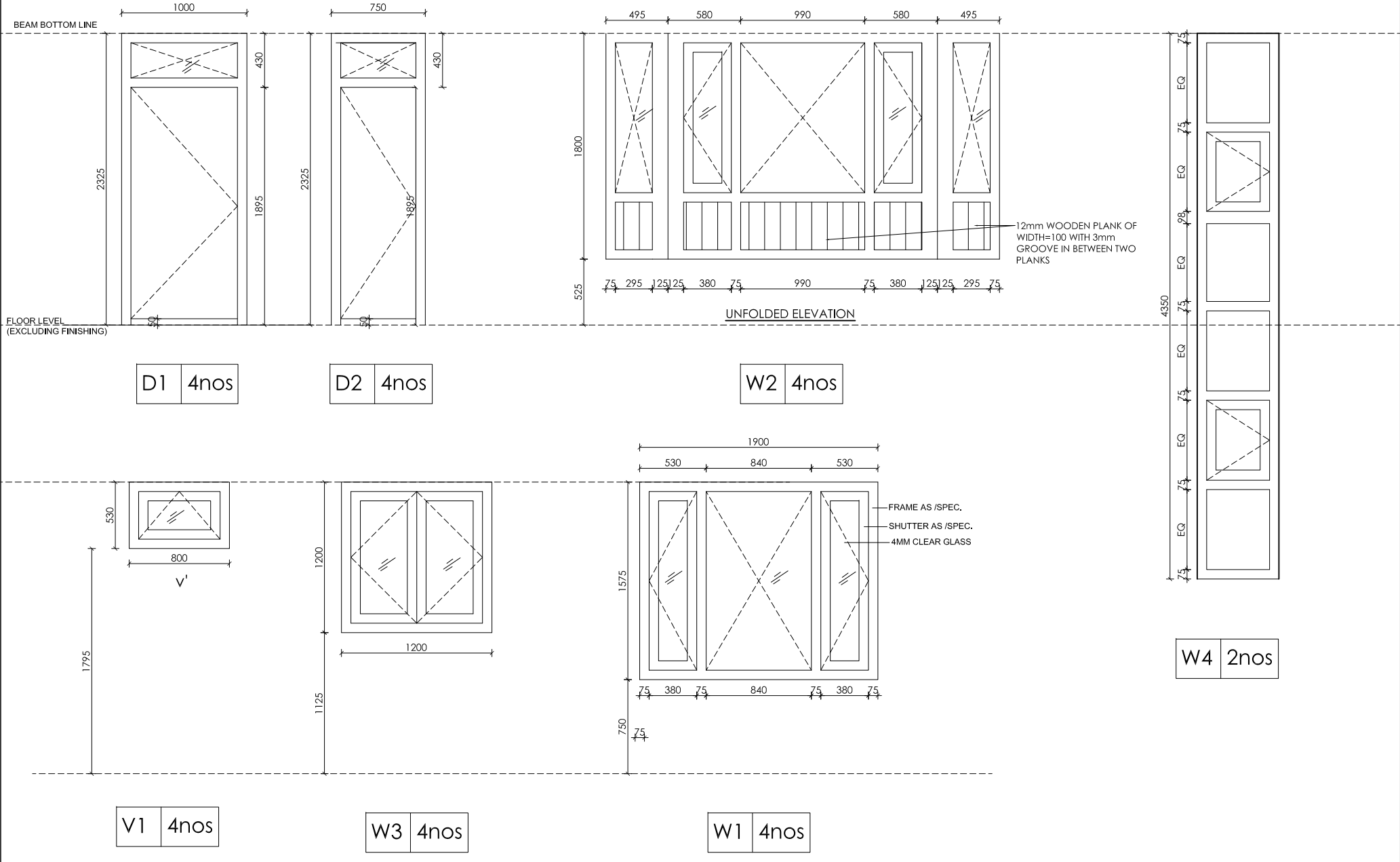

DOOR WINDOW DETAILS
SCALE - 1:40



Management Division
Department of Health Service
Ministry of Health & Population



Health Building Infrastructure
Standard Design Drawings

Job Name:
Four Unit Staff Quarter
Framed structure, 2-storey

Scale: 1:100

Date: 2070/6/7

Drawing title:
Wall Section and
Opening Details

Sheet no:
AR/05
4S/Q

POST MORTEM TYPE A

Area: 147.10 sq. m.

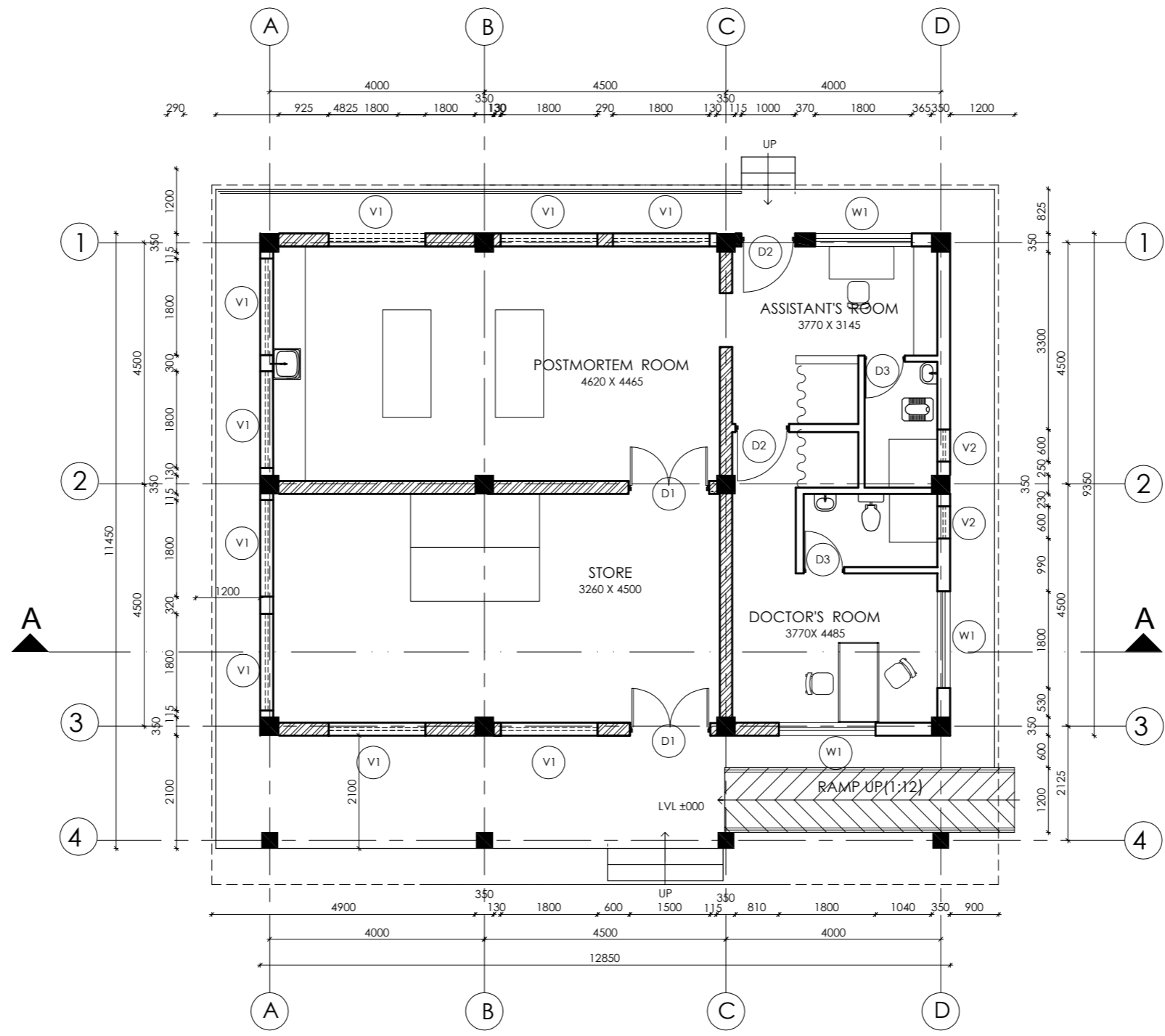

GROUND FLOOR PLAN

Area : 147.10 sq.m.



**Management Division
Department of Health Service
Ministry of Health**



**Health Building Infrastructure
Standard Design Drawings**

Job Name:
POSTMORTEM Type A
Brick / Single storied

Scale: 1:100

Date : 2070/6/7

Drawing title:
Floor Plans lw
Furniture Layout

Sheet no:

**AR/01
PM-A**

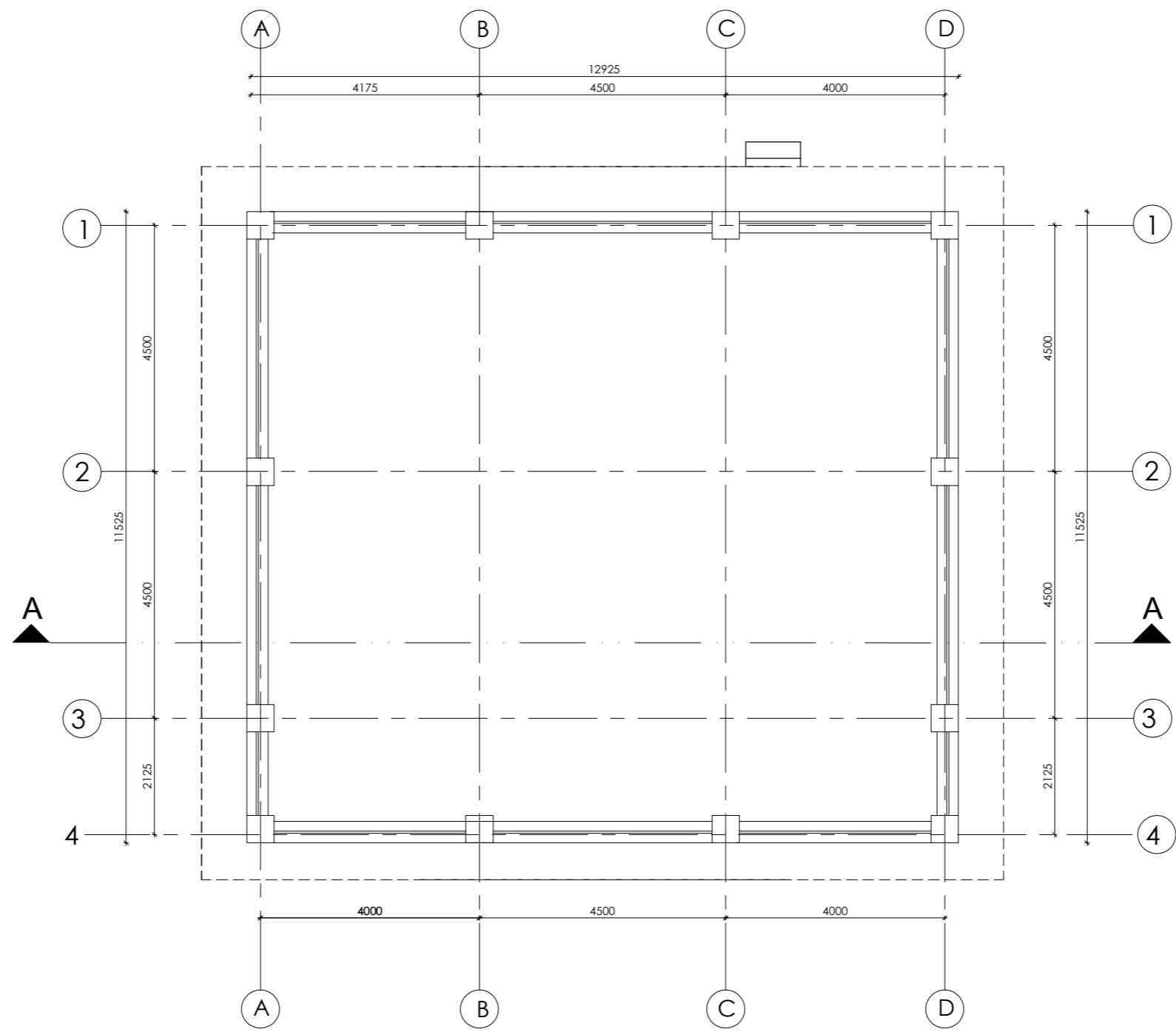

ROOF PLAN



**Management Division
Department of Health Service
Ministry of Health**



**Health Building Infrastructure
Standard Design Drawings**

Job Name:
POSTMORTEM Type A
Brick / Single storied

Scale: 1:100

Date : 2070/6/7

Drawing title:
Floor Plans lw
Furniture Layout

Sheet no:

**AR/02
PM-A**



FRONT ELEVATION

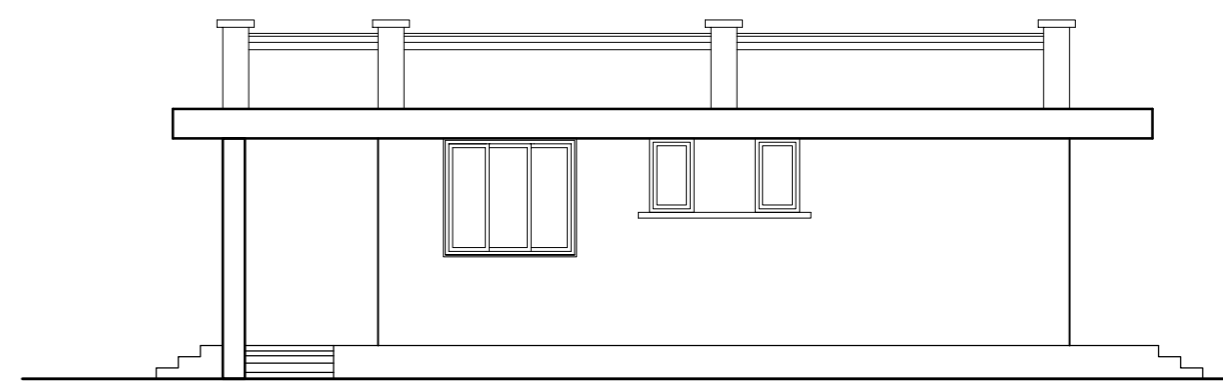

SIDE ELEVATION

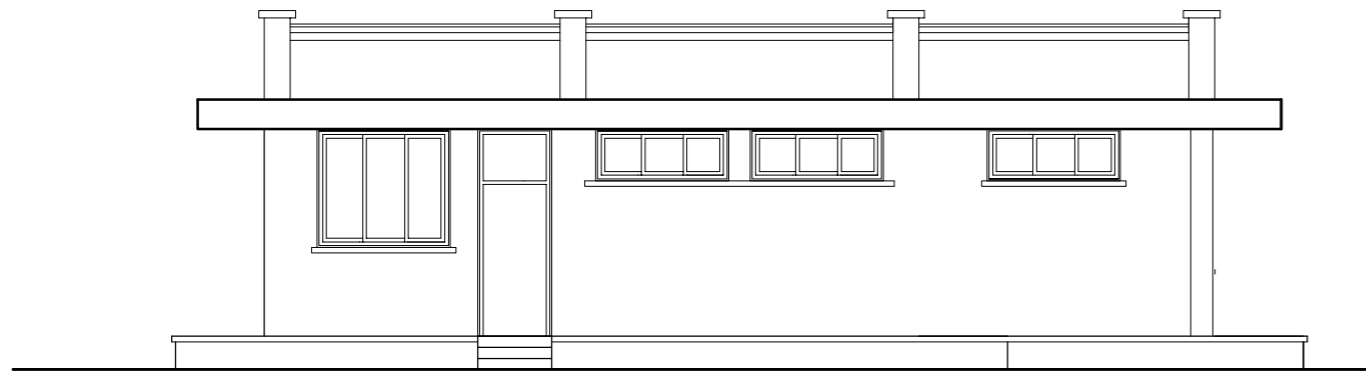

BACK ELEVATION

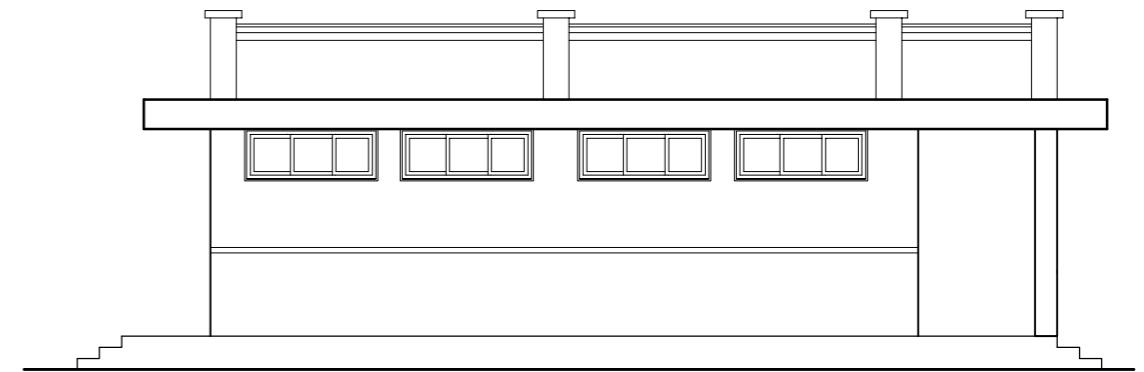

SIDE ELEVATION

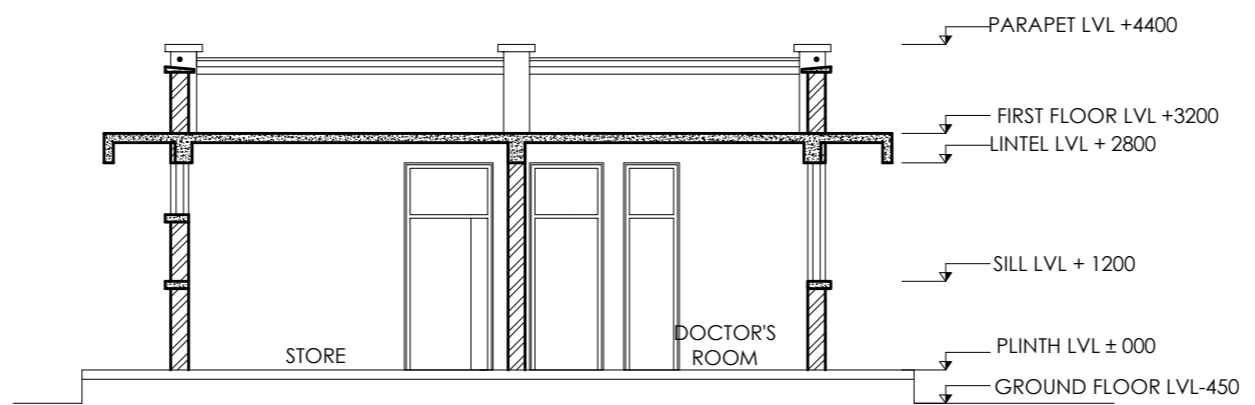

SECTION AT AA



Management Division
Department of Health Service
Ministry of Health



Health Building Infrastructure
Standard Design Drawings

Job Name:
POSTMORTEM Type A
Brick / Single storied
Scale: 1:100
Date : 2070/6/7

Drawing title:
Elevation and section

Sheet no:
AR/03
PM-A

OPENING TYPE	W1	V1	V2	D1	D2	D3
FLOOR LEVEL LINTEL LEVEL SHAPE AND SIZE FLOOR FINISH LEVEL STRUCTURE LEVEL						
QUANTITY	3	9	2	2	2	2
SPECIFICATION	SLIDING	SLIDING	MOVABLE	flush door	flush door	flush door
LOCATION	GROUND FLOOR	GROUND FLOOR	GROUND FLOOR	store, post mortem room	Assistant room, doctor room	Attach toilet



Management Division
Department of Health Service
Ministry of Health



Health Building Infrastructure
Standard Design Drawings

Job Name:

POSTMORTEM Type A
Brick / Single storied

Scale: 1:100

Date : 2070/6/7

Drawing title:
Opening
Schedule

Sheet no:

AR/04
PM-A

POST MORTEM TYPE B

Area: 101.30 sq. m.

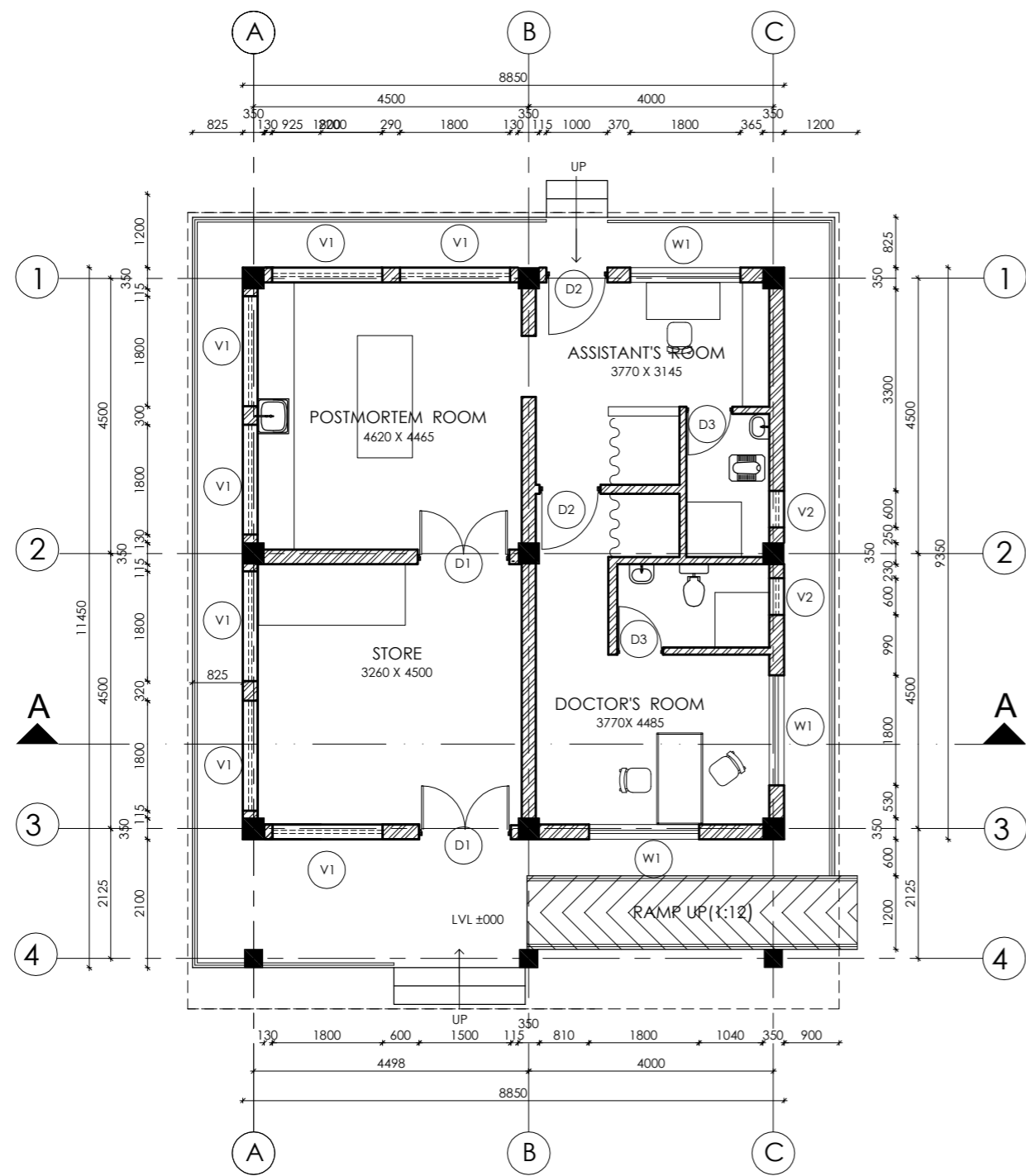

GROUND FLOOR PLAN
Area: 101.30 sq.m.

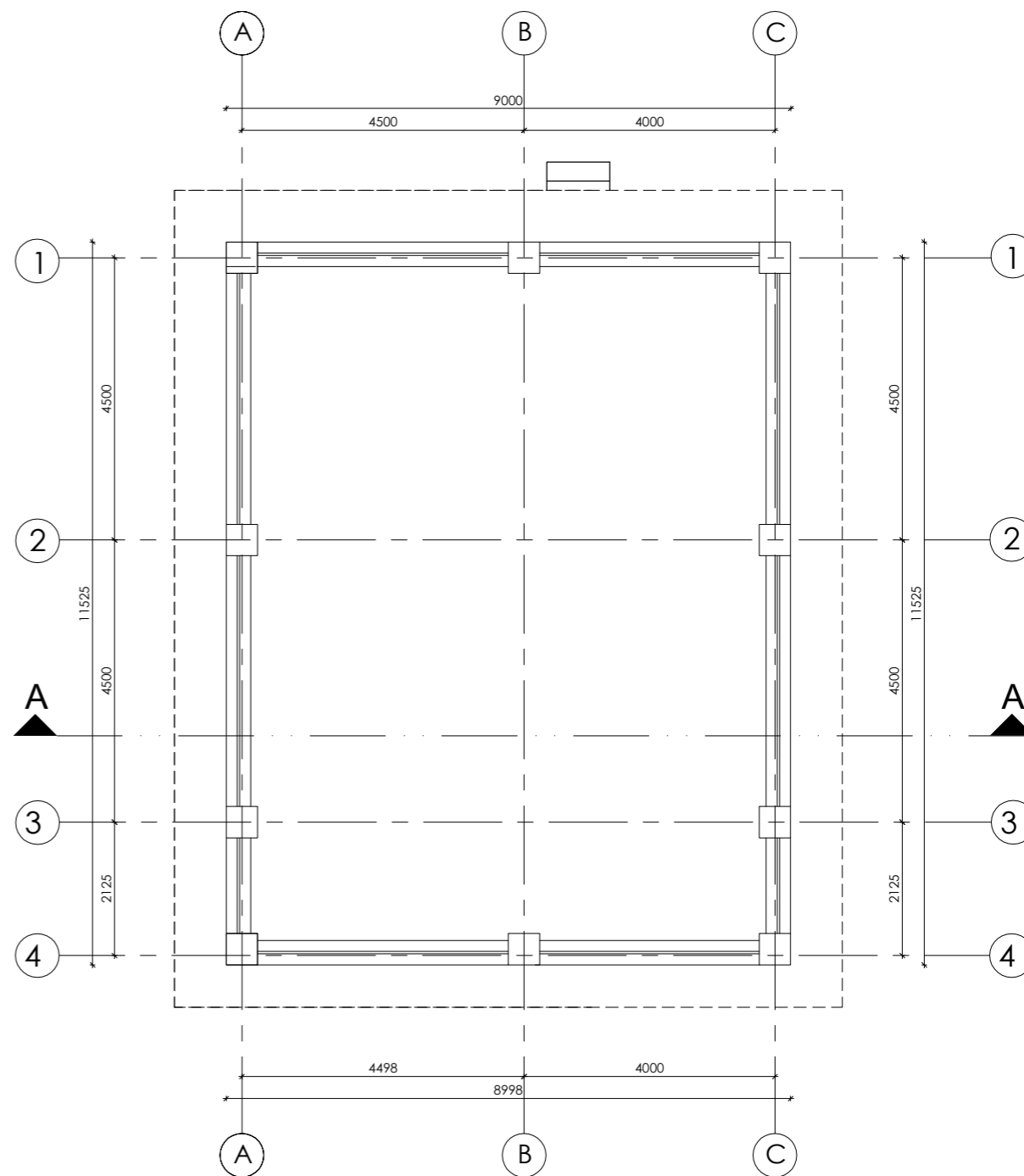

ROOF PLAN



Management Division
Department of Health Service
Ministry of Health



Health Building Infrastructure
Standard Design Drawings

Job Name:

POSTMORTEM Type B
Brick / Single storied

Scale: 1:100

Date : 2070/6/7

Drawing title:
Floor Plans

Sheet no:

AR/01
PM-B



FRONT ELEVATION

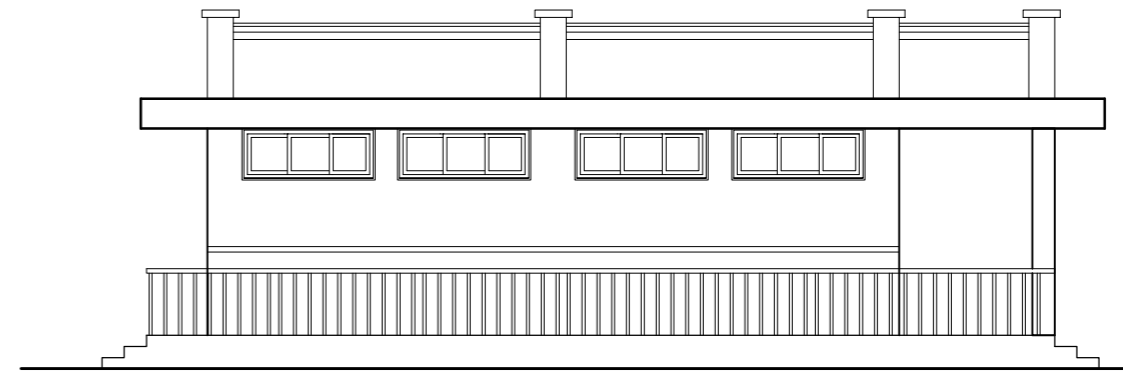

SIDE ELEVATION

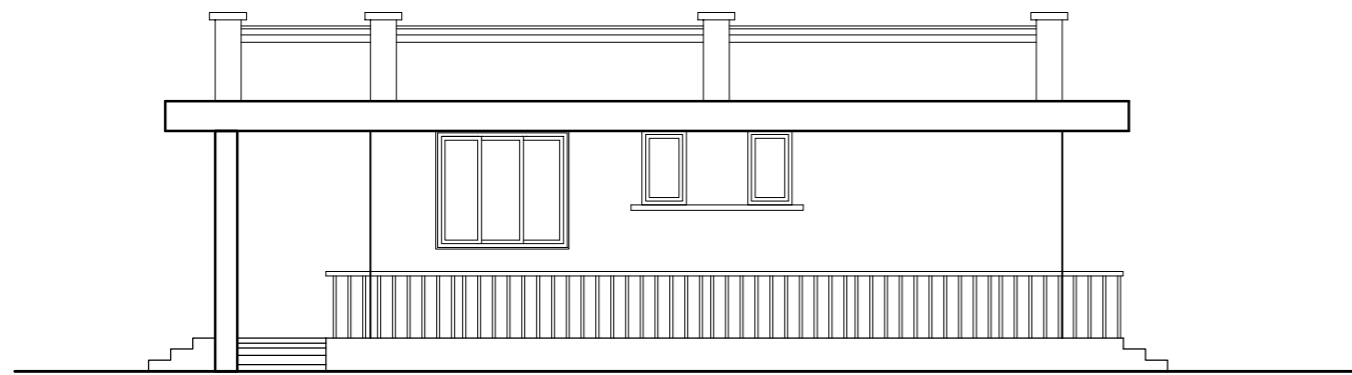

SIDE ELEVATION



BACK ELEVATION

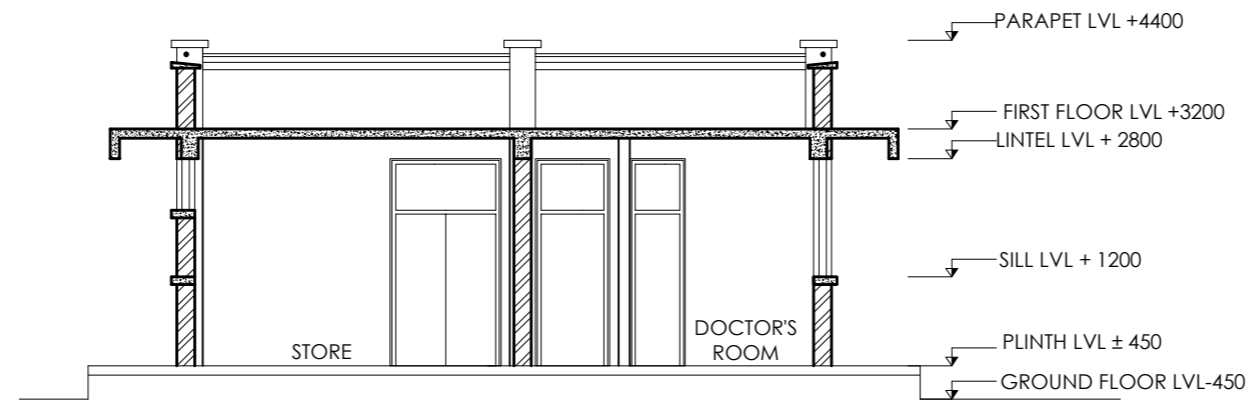

SECTION AT AA



**Management Division
Department of Health Service
Ministry of Health**



**Health Building Infrastructure
Standard Design Drawings**

Job Name:

POSTMORTEM Type B
Brick / Single storied

Scale: 1:100

Date : 2070/6/7

Drawing title:
Elevation and section

Sheet no:

**AR/02
PM-B**

OPENING TYPE	W1	V1	V2	D1	D2	D3
FLOOR LEVEL LINTEL LEVEL SHAPE AND SIZE FLOOR FINISH LEVEL STRUCTURE LEVEL						
QUANTITY	3	7	2	2	2	2
SPECIFICATION	SLIDING	SLIDING	MOVABLE	flush door	flush door	flush door
LOCATION	GROUND FLOOR	GROUND FLOOR	GROUND FLOOR	store, post mortem room	Assistant room, doctor room	Attach toilet



Management Division
Department of Health Service
Ministry of Health



Health Building Infrastructure
Standard Design Drawings

Job Name:

POSTMORTEM Type B
Brick / Single storied

Scale: 1:100

Date : 2070/6/7

Drawing title:
Opening
Schedule

Sheet no:

AR/03
PM-B

**URBAN HEALTH PROMOTION CENTER
(WITHOUT WARD OFFICE)**

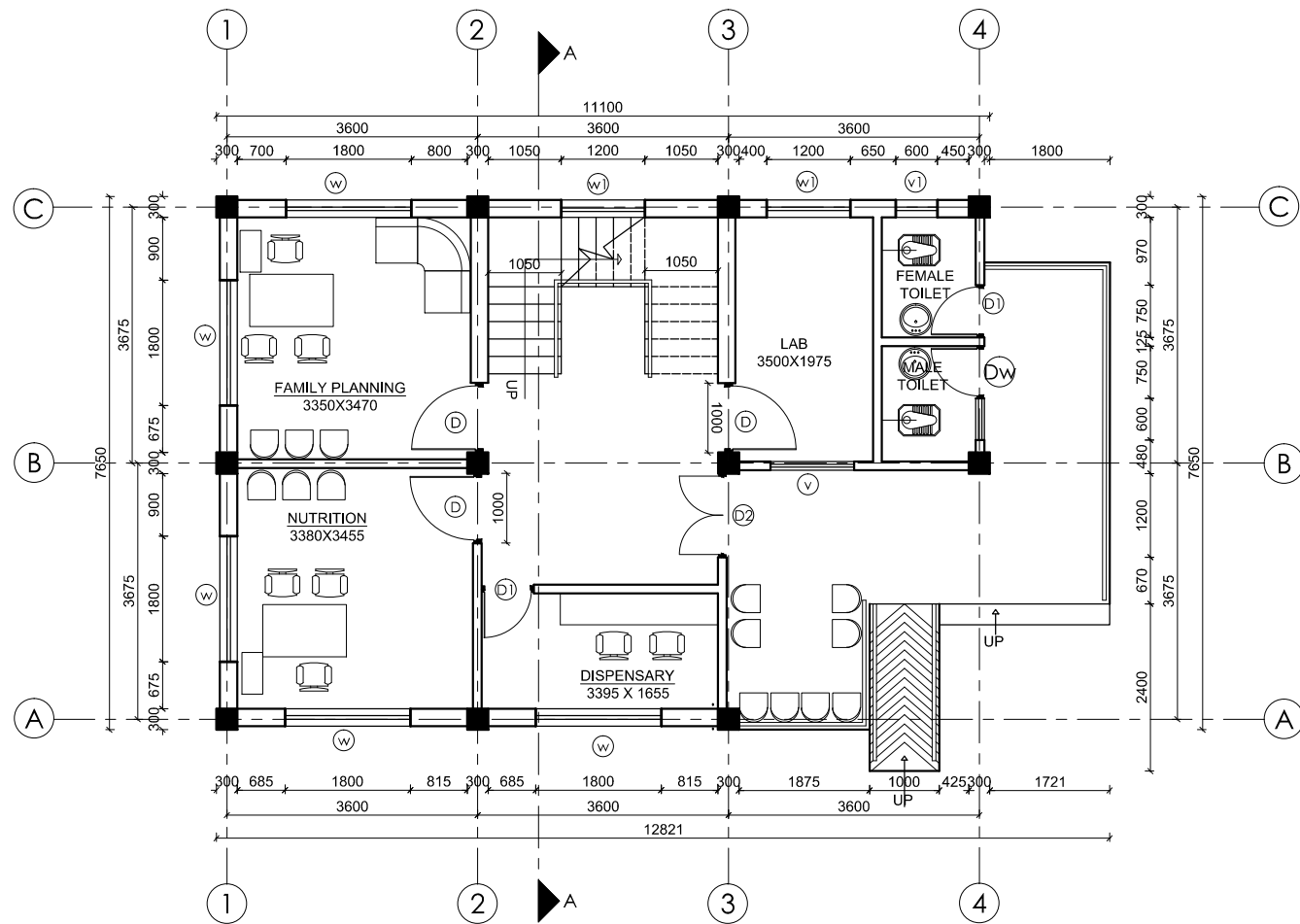

GROUND FLOOR PLAN
AREA: 91.67 SQ. M.

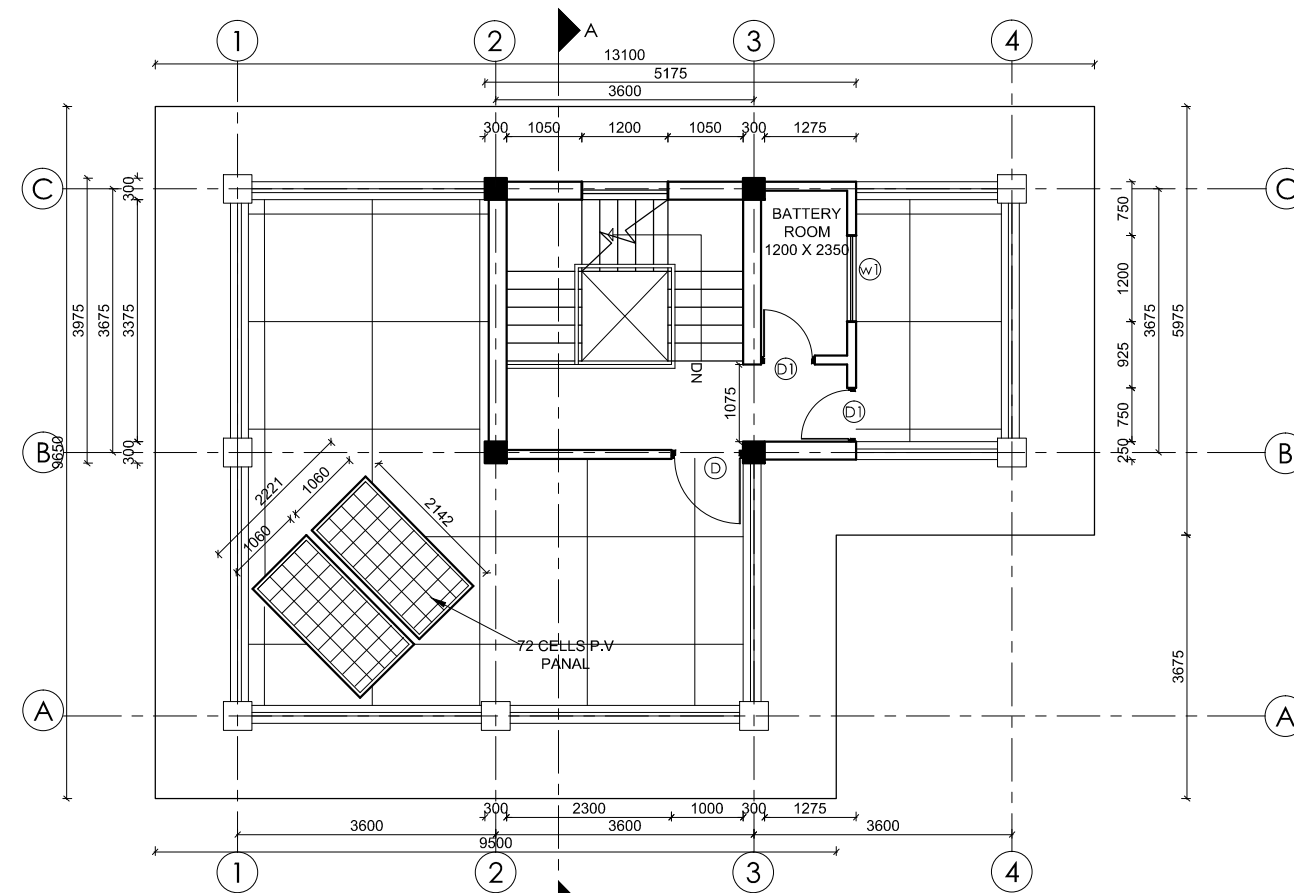

TOP FLOOR PLAN
AREA: 20.27 SQ. M.

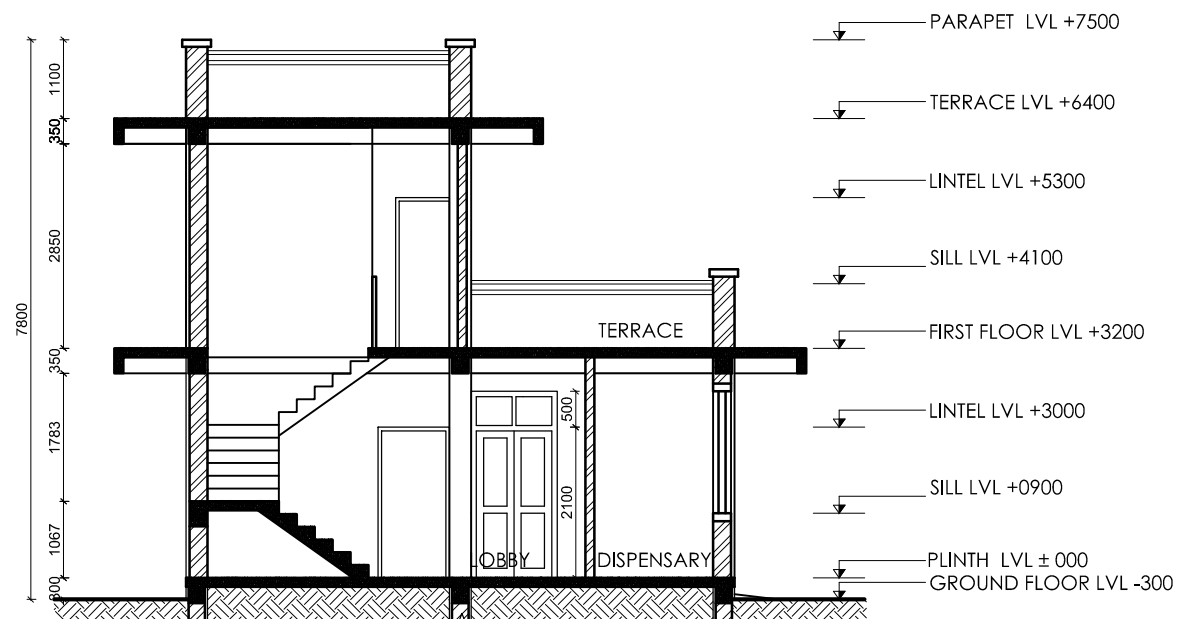

SECTION AT A-A



Management Division
Department of Health Service
Ministry of Health



Health Building Infrastructure
Standard Design Drawings

Job Name:
URBAN HEALTH PROMOTION
CENTRE
(without Ward office)

Scale: 1:100

Date : 2074/4/03

Drawing title:
FLOOR PLANS
&
SECTION

Sheet no:

AR/01

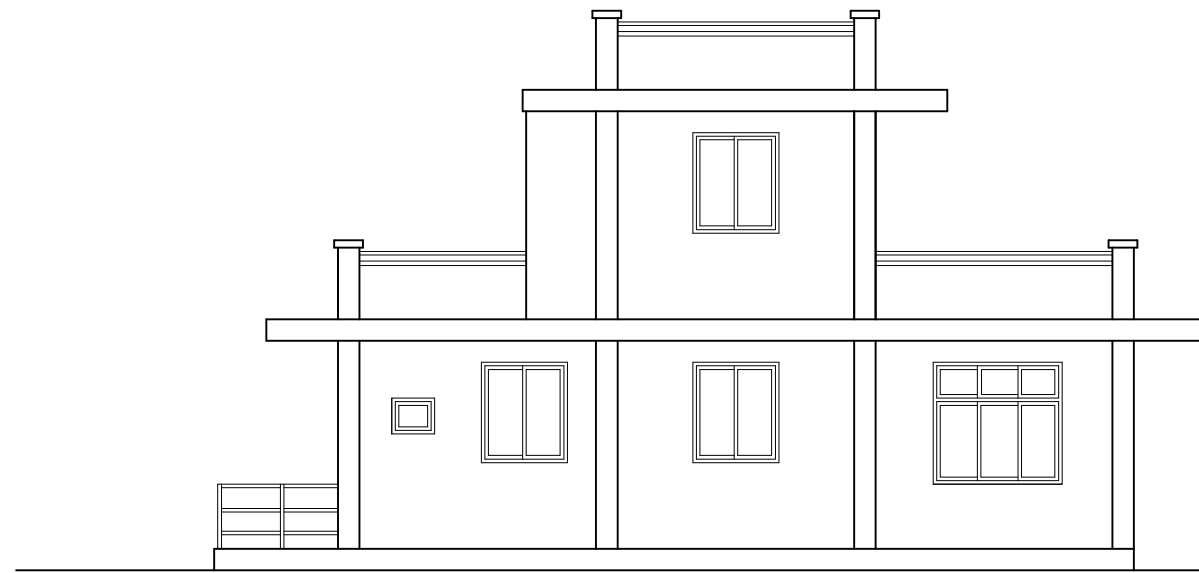

NORTH ELEVATION

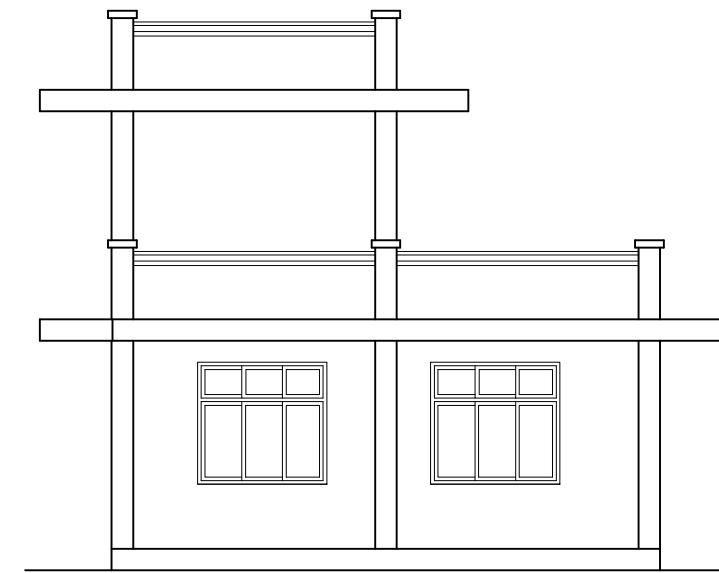

WEST ELEVATION



EAST ELEVATION



SOUTH ELEVATION



Management Division
Department of Health Service
Ministry of Health



Health Building Infrastructure
Standard Design Drawings

Job Name:
URBAN HEALTH PROMOTION
CENTRE
(without Ward office)

Scale: 1:100

Date : 2074/4/03

Drawing title:

ELEVATIONS

Sheet no:

AR/02

**URBAN HEALTH PROMOTION CENTER
(WITH WARD OFFICE)**

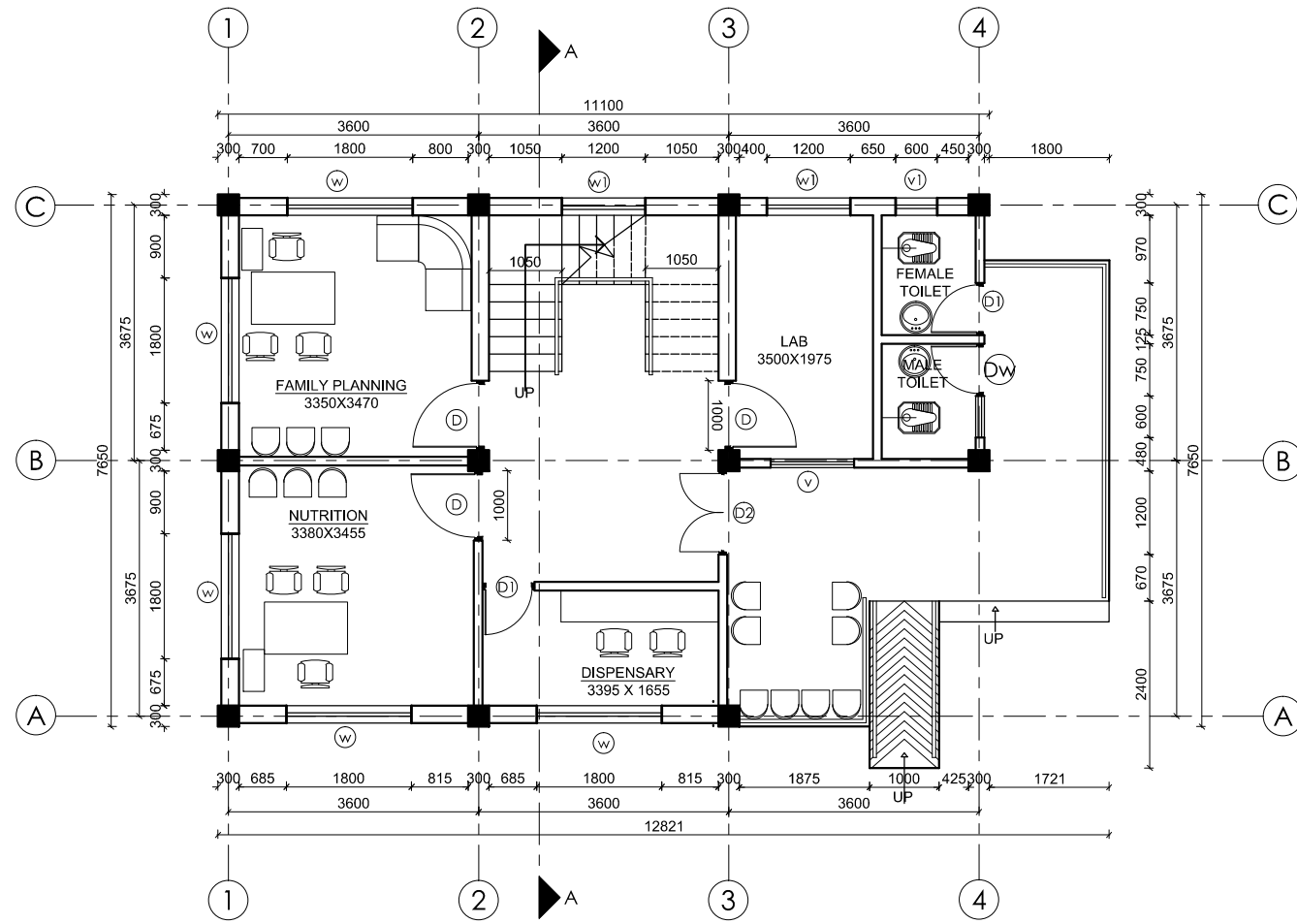

GROUND FLOOR PLAN
AREA: 91.67 SQ. M.

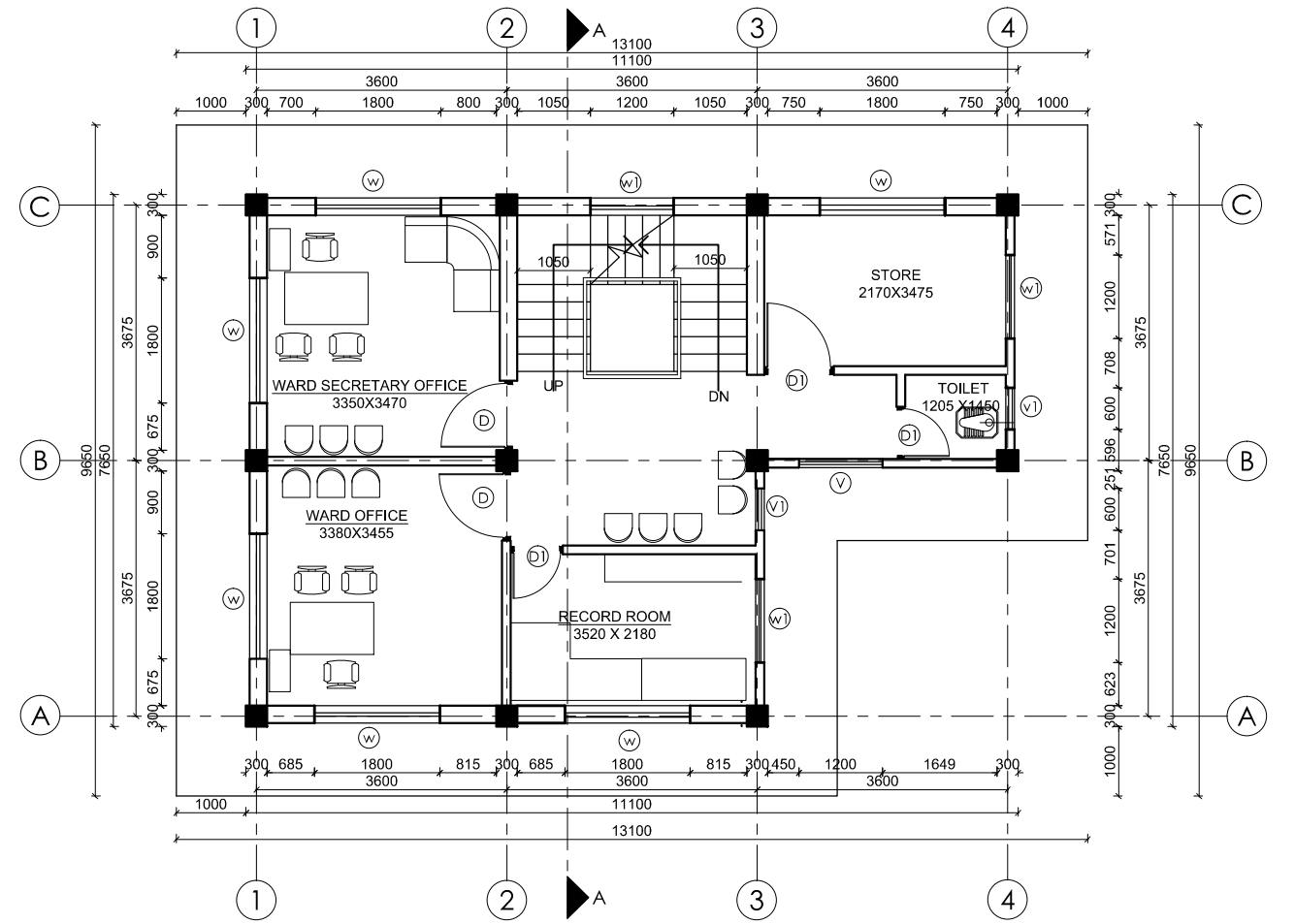

FIRST FLOOR PLAN
AREA: 72.07 SQ. M



Management Division
Department of Health Service
Ministry of Health



Health Building Infrastructure
Standard Design Drawings

Job Name:
URBAN HEALTH PROMOTION
CENTRE
(with Ward office)

Scale: 1:100

Date: 2074/4/03

Drawing title:

PLANS

Sheet no:

AR/01

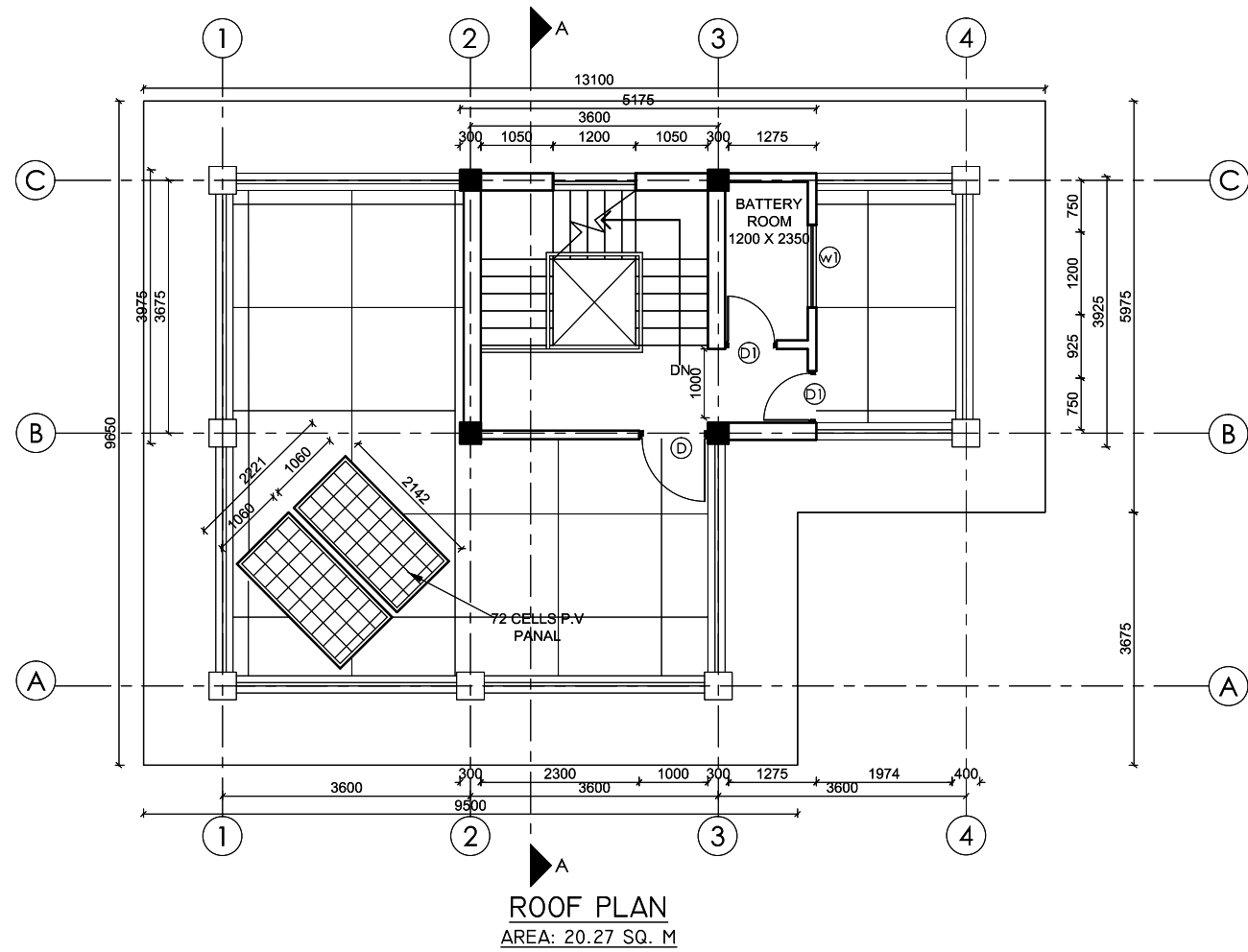

URBAN HEALTH PROMOTION CENTER

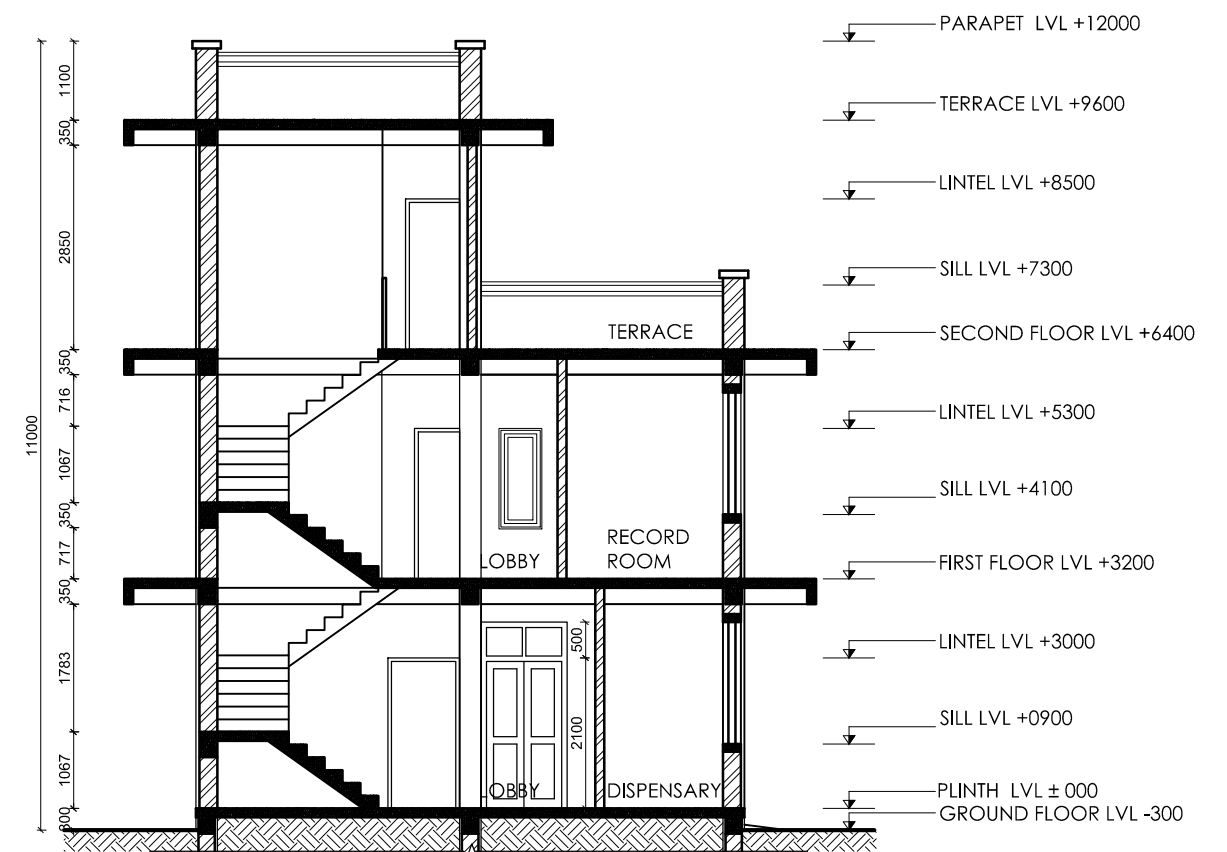

SECTION AT A-A



Management Division
 Department of Health Service
 Ministry of Health



Health Building Infrastructure
 Standard Design Drawings

Job Name:
 URBAN HEALTH PROMOTION
 CENTRE
 (with Ward office)

Scale: 1:100

Date: 2074/4/03

Drawing title:
 ROOF PLAN
 &
 SECTION

Sheet no:

AR/02



EAST ELEVATION

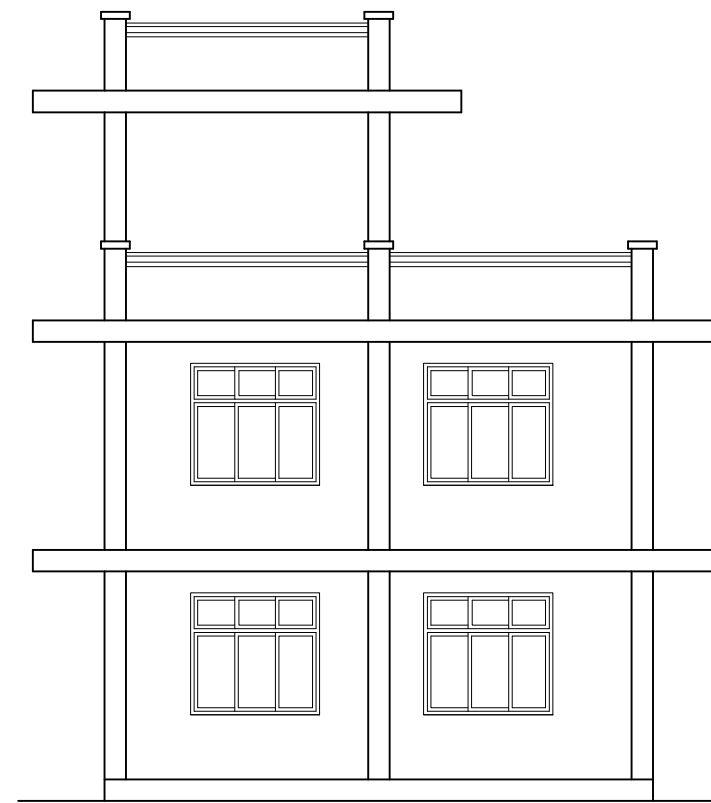

WEST ELEVATION



NORTH ELEVATION



SOUTH ELEVATION



Management Division
Department of Health Service
Ministry of Health



Health Building Infrastructure
Standard Design Drawings

Job Name:
URBAN HEALTH PROMOTION
CENTRE
(with Ward office)

Scale: 1:100

Date : 2074/4/03

Drawing title:

ELEVATIONS

Sheet no:

AR/03